

## Features

- Low-voltage and Standard-voltage Operation
  - 5.0 ( $V_{CC} = 4.5V$  to 5.5V)
  - 2.7 ( $V_{CC} = 2.7V$  to 5.5V)
- Internally Organized 128 x 8 (1K), 256 x 8 (2K), 512 x 8 (4K), 1024 x 8 (8K) or 2048 x 8 (16K)
- 2-wire Serial Interface
- Schmitt Trigger, Filtered Inputs for Noise Suppression
- Bi-directional Data Transfer Protocol
- 100 kHz (2.7V) and 400 kHz (5V) Compatibility
- 8-byte Page (1K, 2K), 16-byte Page (4K, 8K, 16K) Write Modes
- Partial Page Writes Are Allowed
- Self-timed Write Cycle (10 ms max)
- High-reliability
  - Endurance: 100,000 Write Cycles
  - Data Retention: 100 Years
  - ESD Protection: >3000V

## Description

The AT24C01A/02SC/04SC/08SC/16SC provides 1024/2048/4096/8192/16384 bits of serial, electrically-erasable and programmable read-only memory (EEPROM) organized as 128/256/512/1024/2048 words of 8 bits each. The devices are optimized for use in smart card applications where low-power and low-voltage operation may be essential. The devices are available in several standard ISO 7816 smart card modules (see Ordering Information). The entire family is available in both high-voltage (4.5V to 5.5V) and low-voltage (2.7V to 5.5V) versions. All devices are functionally equivalent to Atmel serial EEPROM products offered in standard IC packages (PDIP, SOIC, EIAJ, LAP), with the exception of the slave address and Write Protect functions, which are not required for smart card applications.

## Pin Configurations

Pad Name	Description	ISO Module Contact
VCC	Power Supply Voltage	C1
GND	Ground	C5
SCL	Serial Clock Input	C3
SDA	Serial Data Input/Output	C7
NC	No Connect	C2, C4, C6, C8

## Card Module Contact

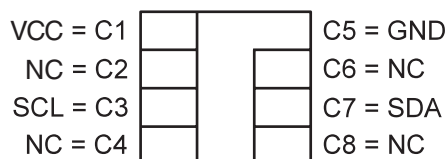

## 2-wire Serial EEPROM Smart Card Modules

1K (128 x 8)

2K (256 x 8)

4K (512 x 8)

8K (1024 x 8)

16K (2048 x 8)

AT24C01ASC

AT24C02SC

AT24C04SC

AT24C08SC

AT24C16SC



## Absolute Maximum Ratings

Operating Temperature.....	-55°C to +125°C
Storage Temperature.....	-65°C to +150°C
Voltage on Any Pin with Respect to Ground.....	-1.0V to +7.0V
Maximum Operating Voltage.....	6.25V
DC Output Current.....	5.0 mA

**\*NOTICE:** Stresses beyond those listed under “Absolute Maximum Ratings” may cause permanent damage to the device. This is a stress rating only and functional operation of the device at these or any other conditions beyond those indicated in the operational sections of this specification is not implied. Exposure to absolute maximum rating conditions for extended periods may affect device reliability.

## Block Diagram

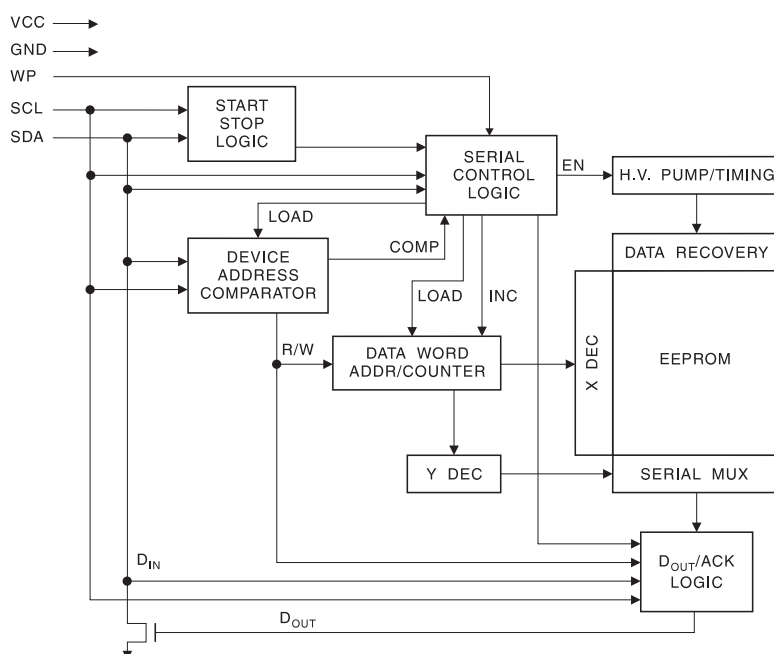

## Pin Description

**SERIAL CLOCK (SCL):** The SCL input is used to positive edge clock data into each EEPROM device and negative edge clock data out of each device.

**SERIAL DATA (SDA):** The SDA pin is bi-directional for serial data transfer. This pin is open-drain driven and may be wire-ORed with any number of other open-drain or open-collector devices.

## Memory Organization

**AT24C01ASC, 1K SERIAL EEPROM:** Internally organized with 16 pages of 8 bytes each, the 1K requires a 7-bit data word address for random word addressing.

**AT24C02SC, 2K SERIAL EEPROM:** Internally organized with 32 pages of 8 bytes each, the 2K requires an 8-bit data word address for random word addressing.

**AT24C04SC, 4K SERIAL EEPROM:** The 4K is internally organized with 32 pages of 16 bytes each. Random word addressing Chip Number requires a 9-bit data word address.

**AT24C08SC, 8K SERIAL EEPROM:** The 8K is internally organized with 64 pages of 16 bytes each. Random word addressing requires a 10-bit data word address.

**AT24C16SC, 16K SERIAL EEPROM:** The 16K is internally organized with 128 pages of 16 bytes each. Random word addressing requires an 11-bit data word address.

## Pin Capacitance<sup>(1)</sup>

Applicable over recommended operating range from  $T_A = 25^\circ\text{C}$ ,  $f = 1.0\text{ MHz}$ ,  $V_{CC} = +2.7\text{V}$ .

Symbol	Test Condition	Max	Units	Conditions
$C_{I/O}$	Input/Output Capacitance (SDA)	8	pF	$V_{I/O} = 0\text{V}$
$C_{IN}$	Input Capacitance (SCL)	6	pF	$V_{IN} = 0\text{V}$

Note: 1. This parameter is characterized and is not 100% tested.

## DC Characteristics

Applicable over recommended operating range from:  $T_{AC} = 0^\circ\text{C}$  to  $+70^\circ\text{C}$ ,  $V_{CC} = +2.7\text{V}$  to  $+5.5\text{V}$  (unless otherwise noted).

Symbol	Parameter	Test Condition	Min	Typ	Max	Units
$V_{CC1}$	Supply Voltage		2.7		5.5	V
$V_{CC2}$	Supply Voltage		4.5		5.5	V
$I_{CC}$	Supply Current $V_{CC} = 5.0\text{V}$	READ at 100 kHz		0.4	1.0	mA
$I_{CC}$	Supply Current $V_{CC} = 5.0\text{V}$	WRITE at 100 kHz		2.0	3.0	mA
$I_{SB1}$	Standby Current $V_{CC} = 2.7\text{V}$	$V_{IN} = V_{CC}$ or GND		1.6	4.0	$\mu\text{A}$
$I_{SB2}$	Standby Current $V_{CC} = 5.0\text{V}$	$V_{IN} = V_{CC}$ or GND		8.0	18.0	$\mu\text{A}$
$I_{LI}$	Input Leakage Current	$V_{IN} = V_{CC}$ or GND		0.10	3.0	$\mu\text{A}$
$I_{LO}$	Output Leakage Current	$V_{OUT} = V_{CC}$ or GND		0.05	3.0	$\mu\text{A}$
$V_{IL}$	Input Low Level <sup>(1)</sup>		-0.6		$V_{CC} \times 0.3$	V
$V_{IH}$	Input High Level <sup>(1)</sup>		$V_{CC} \times 0.7$		$V_{CC} + 0.5$	V
$V_{OL}$	Output Low Level $V_{CC} = 3.0\text{V}$	$I_{OL} = 2.1\text{ mA}$			0.4	V

Note: 1.  $V_{IL}$  min and  $V_{IH}$  max are reference only and are not tested.

## AC Characteristics

Applicable over recommended operating range from  $T_A = 0^\circ\text{C}$  to  $+70^\circ\text{C}$ ,  $V_{CC} = +2.7\text{V}$  to  $+5.5\text{V}$ ,  $CL = 1\text{ TTL Gate}$  and  $100\text{ pF}$  (unless otherwise noted).

Symbol	Parameter	2.7-volt		5.0-volt		Units
		Min	Max	Min	Max	
$f_{SCL}$	Clock Frequency, SCL		100		400	kHz
$t_{LOW}$	Clock Pulse Width Low	4.7		1.2		$\mu\text{s}$
$t_{HIGH}$	Clock Pulse Width High	4.0		0.6		$\mu\text{s}$
$t_I$	Noise Suppression Time <sup>(1)</sup>		100		50	ns
$t_{AA}$	Clock Low to Data Out Valid	0.1	4.5	0.1	0.9	$\mu\text{s}$
$t_{BUF}$	Time the bus must be free before a new transmission can start <sup>(1)</sup>	4.7		1.2		$\mu\text{s}$
$t_{HD.STA}$	Start Hold Time	4.0		0.6		$\mu\text{s}$
$t_{SU.STA}$	Start Setup Time	4.7		0.6		$\mu\text{s}$
$t_{HD.DAT}$	Data In Hold Time	0		0		$\mu\text{s}$
$t_{SU.DAT}$	Data In Setup Time	200		100		ns
$t_R$	Inputs Rise Time <sup>(1)</sup>		1.0		0.3	$\mu\text{s}$



## AC Characteristics (Continued)

Applicable over recommended operating range from  $T_A = 0^\circ\text{C}$  to  $+70^\circ\text{C}$ ,  $V_{CC} = +2.7\text{V}$  to  $+5.5\text{V}$ ,  $CL = 1$  TTL Gate and 100 pF (unless otherwise noted).

Symbol	Parameter	2.7-volt		5.0-volt		Units
		Min	Max	Min	Max	
$t_F$	Inputs Fall Time <sup>(1)</sup>		300		300	ns
$t_{SU,STO}$	Stop Setup Time	4.7		0.6		$\mu\text{s}$
$t_{DH}$	Data Out Hold Time	100		50		ns
$t_{WR}$	Write Cycle Time		10		10	ms
Endurance <sup>(1)</sup>	5.0V, 25°C, Page Mode	100K		100K		Write Cycles

Note: 1. This parameter is characterized and is not 100% tested.

## Device Operation

**CLOCK and DATA TRANSITIONS:** The SDA pin is normally pulled high with an external device. Data on the SDA pin may change only during SCL low time periods (refer to Data Validity timing diagram). Data changes during SCL high periods will indicate a start or stop condition as defined below.

**START CONDITION:** A high-to-low transition of SDA with SCL high is a start condition that must precede any other command (refer to Start and Stop Definition timing diagram).

**STOP CONDITION:** A low-to-high transition of SDA with SCL high is a stop condition. After a read sequence, the Stop command will place the EEPROM in a standby power mode (refer to Start and Stop Definition timing diagram).

**ACKNOWLEDGE:** All addresses and data words are serially transmitted to and from the EEPROM in 8-bit words. Each word requires the receiver to acknowledge that it has received a valid command or data byte. During the transmission of commands from the host to the EEPROM, the EEPROM will send a zero to the host to

acknowledge that it has received a valid command byte. This occurs on the ninth clock cycle of the command byte. During read operations, the host will send a zero to the EEPROM to acknowledge that it has received a valid data byte and that it requests the next sequential data byte to be transmitted during the subsequent eight clock cycles. This occurs on the ninth clock cycle of the data byte. If the host does not transmit this acknowledge bit, the EEPROM will disable the Read operation and return to standby mode.

**STANDBY MODE:** The AT24C01ASC/02SC/04SC/08SC/16SC features a low-power standby mode that is enabled: (a) upon power-up and (b) after the receipt of the STOP bit and the completion of any internal operations.

**MEMORY RESET:** After an interruption in protocol, power loss or system reset, any 2-wire part can be reset by following these steps:

1. Clock up to 9 cycles.
2. Look for SDA high in each cycle while SCL is high.
3. Create a start condition as SDA is high.

## Bus Timing

SCL: Serial Clock, SDA: Serial Data I/O

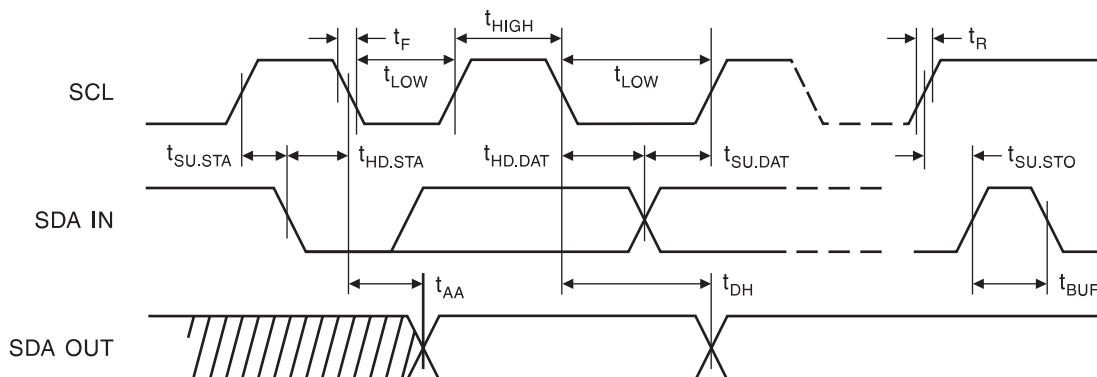

## Write Cycle Timing

SCL: Serial Clock, SDA: Serial Data I/O

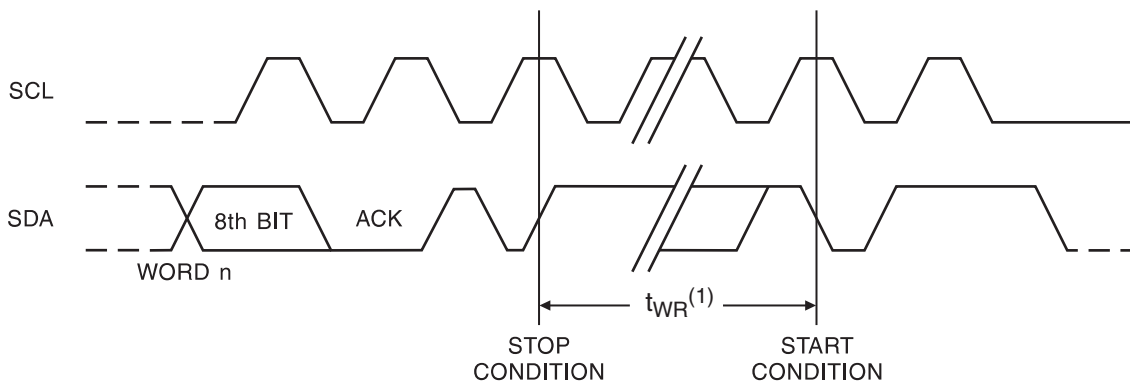

Note: 1. The write cycle time  $t_{WR}$  is the time from a valid stop condition of a write sequence to the end of the internal clear/write cycle.

## Data Validity

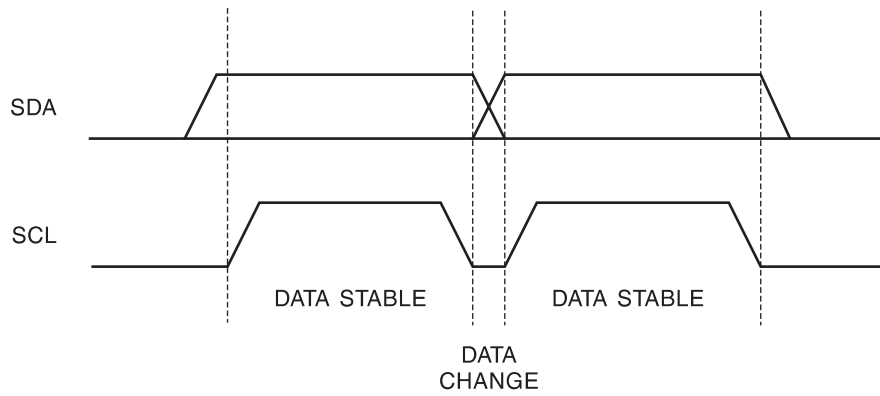

## Start and Stop Definition

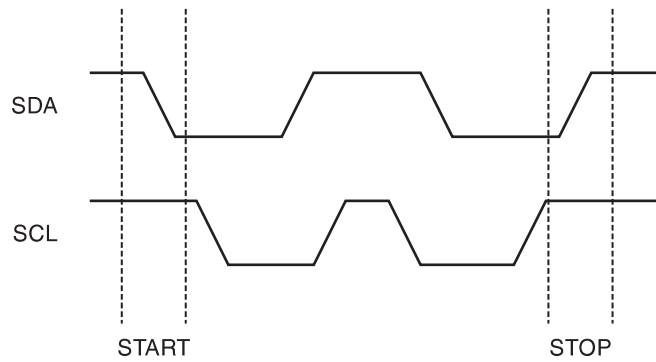

## Output Acknowledge

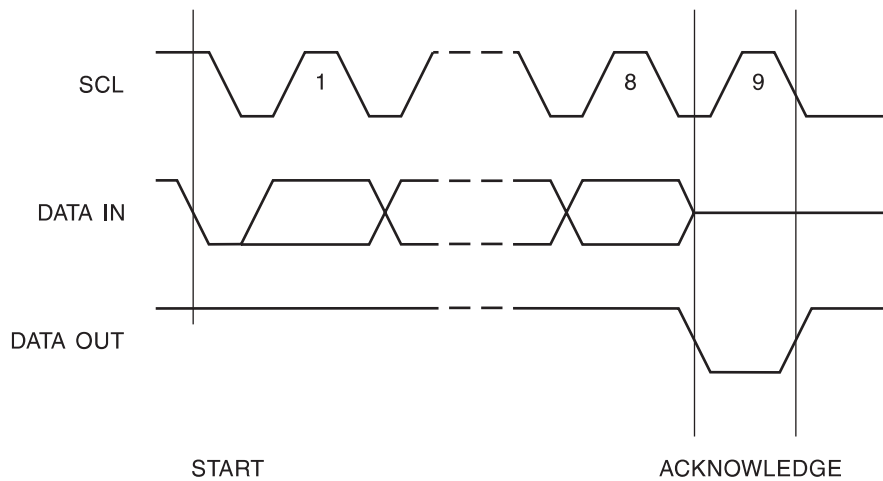

## Device Addressing

The 1K, 2K, 4K, 8K and 16K EEPROM devices all require an 8-bit device address word following a start condition to enable the chip for a read or write operation (refer to Figure 1).

The device address word consists of a mandatory one, zero, one, zero sequence for the first four most significant bits as shown. This is common to all the serial EEPROM devices.

The next 3 bits of the device address word are the most significant data word address bits for the AT24C16SC (16K), which requires a total of 11 address bits. The AT24C08SC (8K) requires only 10 total word address bits. The most significant 2 bits are included in the device address word. The unused bit of the device address word should be set to "0". The AT24C04SC (4K) requires only 9 total data word address bits. The most significant bit is included in the device address word. The 2 unused bits of the device address word should be set to "0". The AT24C02SC (2K) and AT24C01ASC (1K) do not require any address bits in the device address word. The 3 unused bits of the device address word should be set to "0".

The eighth bit of the device address is the read/write operation select bit. A read operation is initiated if this bit is high and a write operation is initiated if this bit is low.

Upon a compare of the device address, the EEPROM will output a zero (ACK). If a successful compare is not made, the chip will return to a standby state (NO ACK).

## Write Operations

**BYTE WRITE:** A write operation requires an 8-bit data word address following the device address word and acknowledgment. Upon receipt of this address, the EEPROM will again respond with a zero (ACK) and then clock in the first 8-bit data word. Following receipt of the 8-bit data word, the EEPROM will output a zero (ACK) and the addressing device, such as a microcontroller, must terminate the write sequence with a stop condition. At this time the EEPROM enters an internally-timed write cycle,  $t_{WR}$ , to the nonvolatile memory. All inputs are disabled during this write cycle and the EEPROM will not respond until the write is complete (refer to Figure 2).

**PAGE WRITE:** The 1K/2K EEPROM is capable of an 8-byte page write, and the 4K, 8K and 16K devices are capable of 16-byte page writes.

A page write is initiated the same as a byte write, but the microcontroller does not send a stop condition after the first data word is clocked in. Instead, after the EEPROM acknowledges receipt of the first data word, the microcontroller can transmit up to 7 (1K/2K) or 15 (4K, 8K, 16K) more data words. The EEPROM will respond with a zero (ACK) after each data word received. The microcontroller

must terminate the page write sequence with a stop condition (refer to Figure 3).

The data word address lower 3 (1K/2K) or 4(4K, 8K, 16K) bits are internally incremented following the receipt of each data word. The higher data word address bits are not incremented, retaining the memory page row location. When the word address, internally generated, reaches the page boundary, the following byte is placed at the beginning of the same page. If more than 8 (1K/2K) or 16 (4K, 8K, 16K) data words are transmitted to the EEPROM, the data word address will "roll over" and previous data will be overwritten.

**ACKNOWLEDGE POLLING:** Once the internally timed write cycle has started and the EEPROM inputs are disabled, acknowledge polling can be initiated. This involves sending a start condition followed by the device address word. The read/write bit is representative of the operation desired. Only if the internal write cycle has completed will the EEPROM respond with a zero (ACK), allowing the read or write sequence to continue.

## Read Operations

Read operations are initiated the same way as write operations, with the exception that the read/write select bit in the device address word is set to one. There are three read operations: current address read, random address read and sequential read.

**CURRENT ADDRESS READ:** The internal data word address counter maintains the last address accessed during the last read or write operation, incremented by one. This address stays valid between operations as long as the chip power is maintained. The address "rollover" during read is from the last byte of the last memory page to the first byte of the first page. The address "rollover" during write is from the last byte of the current page to the first byte of the same page.

Once the device address with the read/write select bit set to "1" is clocked in and acknowledged by the EEPROM, the current address data word is serially clocked out. The microcontroller does not respond with an input zero, but does generate a following stop condition (refer to Figure 4).

**RANDOM READ:** A random read requires a "dummy" byte write sequence to load in the data word address. Once the device address word and data word address are clocked in and acknowledged by the EEPROM, the microcontroller must generate another start condition. The microcontroller now initiates a current address read by sending a device address with the read/write select bit high. The EEPROM acknowledges the device address and serially clocks out the data word. The microcontroller does not respond with a zero (NO ACK) but does generate a following stop condition (refer to Figure 5).

**SEQUENTIAL READ:** Sequential reads are initiated by either a current address read or a random address read. After the microcontroller receives a data word, it responds with an acknowledge. As long as the EEPROM receives an acknowledge, it will continue to increment the data word address and serially clock out sequential data words. When

the memory address limit is reached, the data word address will “rollover” and the sequential read will continue. The sequential read operation is terminated when the microcontroller does not respond with a zero (NO ACK) but does generate a following stop condition (refer to Figure 6).

**Figure 1. Device Address**

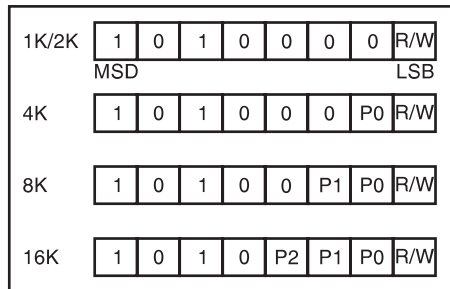

Note: P0, P1, P2 = Data word address bits

**Figure 2. Byte Write**

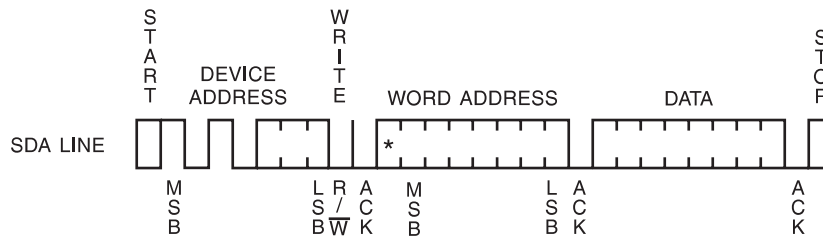

**Figure 3. Page Write**

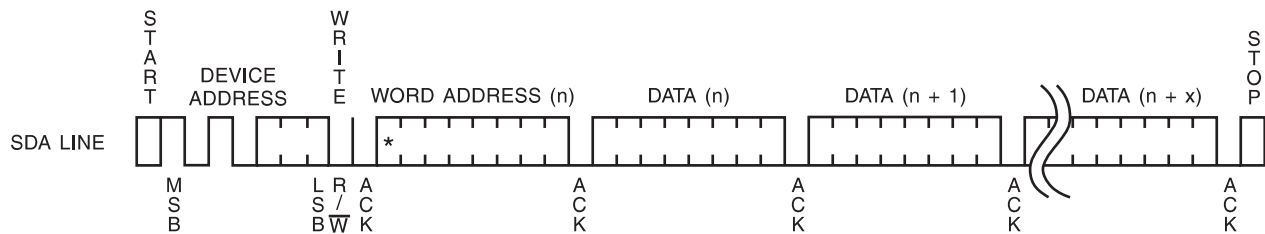

(\* = DON'T CARE bit for 1K)



**Figure 4. Current Address Read**

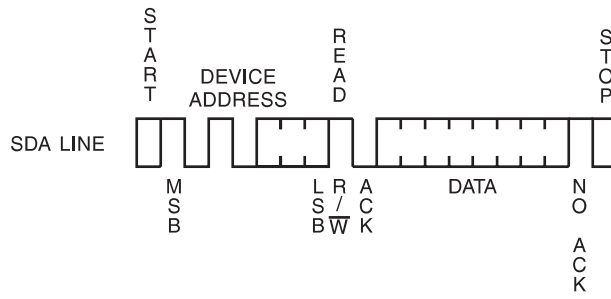

**Figure 5. Random Read**

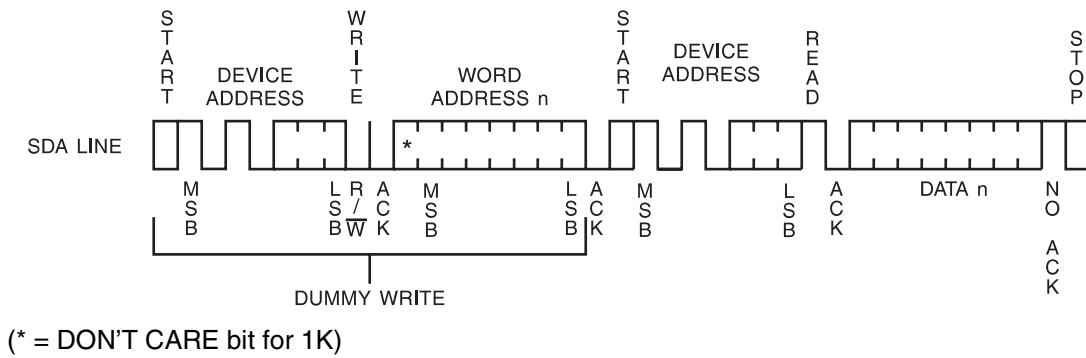

**Figure 6. Sequential Read**

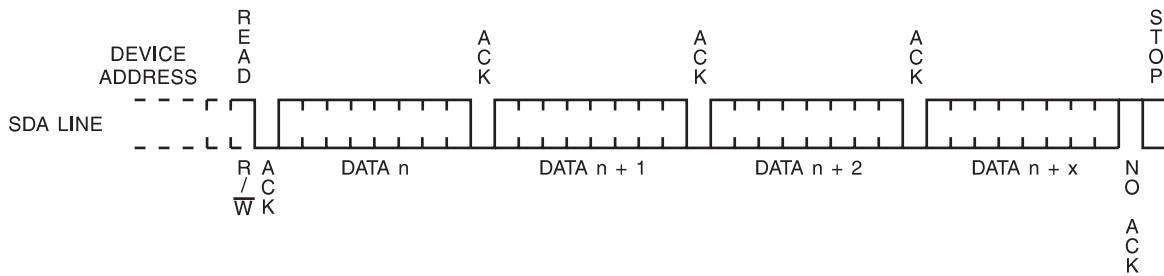



## AT24C01ASC Ordering Information

Ordering Code	Package	Voltage Range	Operation Range
AT24C01ASC - 09AT - 2.7 AT24C01ASC - 09BT - 2.7 AT24C01ASC - 09CT - 2.7 AT24C01ASC - 09DT - 2.7 AT24C01ASC - 09ET - 2.7 AT24C01ASC - 09FT - 2.7 AT24C01ASC - 09GT - 2.7 AT24C01ASC - 09HT - 2.7	M2 - A Module M2 - B Module M4 - C Module M4 - D Module M2 - E Module M2 - F Module M3 - G Module M3 - H Module	2.7V - 5.5V	Commercial (0°C to 70°C)
AT24C01ASC - 09AT AT24C01ASC - 09BT AT24C01ASC - 09CT AT24C01ASC - 09DT AT24C01ASC - 09ET AT24C01ASC - 09FT AT24C01ASC - 09GT AT24C01ASC - 09HT	M2 - A Module M2 - B Module M4 - C Module M4 - D Module M2 - E Module M2 - F Module M3 - G Module M3 - H Module	4.5V - 5.5V	Commercial (0°C to 70°C)

Package Type <sup>(1)</sup>	
<b>M2 - A Module</b>	M2 ISO 7816 Smart Card Module
<b>M2 - B Module</b>	M2 ISO 7816 Smart Card Module with Atmel Logo
<b>M4 - C Module</b>	M4 ISO 7816 Smart Card Module
<b>M4 - D Module</b>	M4 ISO 7816 Smart Card Module with Atmel Logo
<b>M2 - E Module</b>	M2 ISO 7816 Smart Card Module
<b>M2 - F Module</b>	M2 ISO 7816 Smart Card Module
<b>M3 - G Module</b>	M3 ISO 7816 Smart Card Module
<b>M3 - H Module</b>	M3 ISO 7816 Smart Card Module with Atmel Logo

Note: 1. Formal drawings may be obtained from an Atmel sales office.

## AT24C02SC Ordering Information

Ordering Code	Package	Voltage Range	Operation Range
AT24C02SC - 09AT - 2.7 AT24C02SC - 09BT - 2.7 AT24C02SC - 09CT - 2.7 AT24C02SC - 09DT - 2.7 AT24C02SC - 09ET - 2.7 AT24C02SC - 09FT - 2.7	M2 - A Module M2 - B Module M4 - C Module M4 - D Module M2 - E Module M2 - F Module	2.7V - 5.5V	Commercial (0°C to 70°C)
AT24C02SC - 09AT AT24C02SC - 09BT AT24C02SC - 09CT AT24C02SC - 09DT AT24C02SC - 09ET AT24C02SC - 09FT	M2 - A Module M2 - B Module M4 - C Module M4 - D Module M2 - E Module M2 - F Module	4.5V - 5.5V	Commercial (0°C to 70°C)

## AT24C04SC Ordering Information

Ordering Code	Package	Voltage Range	Operation Range
AT24C04SC - 09AT - 2.7 AT24C04SC - 09BT - 2.7 AT24C04SC - 09CT - 2.7 AT24C04SC - 09DT - 2.7 AT24C04SC - 09ET - 2.7 AT24C04SC - 09FT - 2.7	M2 - A Module M2 - B Module M4 - C Module M4 - D Module M2 - E Module M2 - F Module	2.7V - 5.5V	Commercial (0°C to 70°C)
AT24C04SC - 09AT AT24C04SC - 09BT AT24C04SC - 09CT AT24C04SC - 09DT AT24C04SC - 09ET AT24C04SC - 09FT	M2 - A Module M2 - B Module M4 - C Module M4 - D Module M2 - E Module M2 - F Module	4.5V - 5.5V	Commercial (0°C to 70°C)

Package Type <sup>(1)</sup>	
<b>M2 - A Module</b>	M2 ISO 7816 Smart Card Module
<b>M2 - B Module</b>	M2 ISO 7816 Smart Card Module with Atmel Logo
<b>M4 - C Module</b>	M4 ISO 7816 Smart Card Module
<b>M4 - D Module</b>	M4 ISO 7816 Smart Card Module with Atmel Logo
<b>M2 - E Module</b>	M2 ISO 7816 Smart Card Module
<b>M2 - F Module</b>	M2 ISO 7816 Smart Card Module
<b>M3 - G Module</b>	M3 ISO 7816 Smart Card Module
<b>M3 - H Module</b>	M3 ISO 7816 Smart Card Module with Atmel Logo

Note: 1. Formal drawings may be obtained from an Atmel Sales Office.



## AT24C08SC Ordering Information

Ordering Code	Package	Voltage Range	Operation Range
AT24C08SC - 09AT - 2.7 AT24C08SC - 09BT - 2.7 AT24C08SC - 09CT - 2.7 AT24C08SC - 09DT - 2.7 AT24C08SC - 09ET - 2.7 AT24C08SC - 09FT - 2.7	M2 - A Module M2 - B Module M4 - C Module M4 - D Module M2 - E Module M2 - F Module	2.7V - 5.5V	Commercial (0°C to 70°C)
AT24C08SC - 09AT AT24C08SC - 09BT AT24C08SC - 09CT AT24C08SC - 09DT AT24C08SC - 09ET AT24C08SC - 09FT	M2 - A Module M2 - B Module M4 - C Module M4 - D Module M2 - E Module M2 - F Module	4.5V - 5.5V	Commercial (0°C to 70°C)

## AT24C16SC Ordering Information

Ordering Code	Package	Voltage Range	Operation Range
AT24C16SC - 09AT - 2.7 AT24C16SC - 09BT - 2.7 AT24C16SC - 09CT - 2.7 AT24C16SC - 09DT - 2.7 AT24C16SC - 09ET - 2.7 AT24C16SC - 09FT - 2.7	M2 - A Module M2 - B Module M4 - C Module M4 - D Module M2 - E Module M2 - F Module	2.7V - 5.5V	Commercial (0°C to 70°C)
AT24C16SC - 09AT AT24C16SC - 09BT AT24C16SC - 09CT AT24C16SC - 09DT AT24C16SC - 09ET AT24C16SC - 09FT	M2 - A Module M2 - B Module M4 - C Module M4 - D Module M2 - E Module M2 - F Module	4.5V - 5.5V	Commercial (0°C to 70°C)

Package Type <sup>(1)</sup>	
<b>M2 - A Module</b>	M2 ISO 7816 Smart Card Module
<b>M2 - B Module</b>	M2 ISO 7816 Smart Card Module with Atmel Logo
<b>M4 - C Module</b>	M4 ISO 7816 Smart Card Module
<b>M4 - D Module</b>	M4 ISO 7816 Smart Card Module with Atmel Logo
<b>M2 - E Module</b>	M2 ISO 7816 Smart Card Module
<b>M2 - F Module</b>	M2 ISO 7816 Smart Card Module
<b>M3 - G Module</b>	M3 ISO 7816 Smart Card Module
<b>M3 - H Module</b>	M3 ISO 7816 Smart Card Module with Atmel Logo

Note: 1. Formal drawings may be obtained from an Atmel Sales Office.

## Smart Card Modules

### M2 - A Module - Ordering Code: 09AT

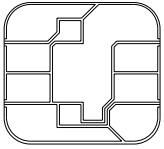

Module Size: M2  
 Dimension<sup>(1)</sup>: 12.6 x 11.4 mm  
 Glob Top: Black, Square: 8.6 x 8.6 mm  
 Thickness: 0.58 mm max.  
 Pitch: 14.25 mm

### M2 - B Module - Ordering Code: 09BT

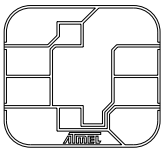

Module Size: M2  
 Dimension<sup>(1)</sup>: 12.6 x 11.4 mm  
 Glob Top: Black, Square: 8.6 x 8.6 mm  
 Thickness: 0.58 mm max.  
 Pitch: 14.25 mm

### M4 - C Module - Ordering Code: 09CT

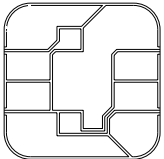

Module Size: M4  
 Dimension<sup>(1)</sup>: 12.6 x 12.6 mm  
 Glob Top: Black, Square: 8.6 x 8.6 mm  
 Thickness: 0.58 mm  
 Pitch: 14.25 mm

### M4 - D Module - Ordering Code: 09DT

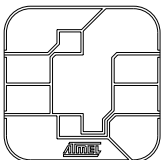

Module Size: M4  
 Dimension<sup>(1)</sup>: 12.6 x 12.6 mm  
 Glob Top: Black, Square: 8.6 x 8.6 mm  
 Thickness: 0.58 mm max.  
 Pitch: 14.25 mm

### M2 - E Module - Ordering Code: 09ET

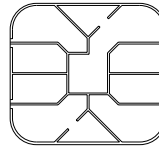

Module Size: M2  
 Dimension<sup>(1)</sup>: 12.6 x 11.4 mm  
 Glob Top: Clear, Round: Ø 7.5 mm max.  
 Thickness: 0.58 mm max.  
 Pitch: 14.25 mm

### M2 - F Module - Ordering Code: 09FT

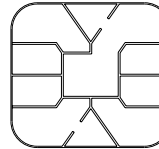

Module Size: M2  
 Dimension<sup>(1)</sup>: 12.6 x 11.4 mm  
 Glob Top: Clear, Round: Ø 8.0 mm max.  
 Thickness: 0.58 mm max.  
 Pitch: 14.25 mm

### M3 - G Module - Ordering Code: 09GT

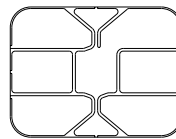

Module Size: M3  
 Dimension<sup>(1)</sup>: 10.6 x 8.0 mm  
 Glob Top: Clear, Round: Ø 6.5 mm max.  
 Thickness: 0.58 mm max.  
 Pitch: 9.5 mm

### M3 - H Module - Ordering Code: 09HT

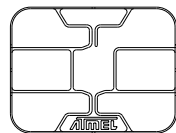

Module Size: M3  
 Dimension<sup>(1)</sup>: 10.6 x 8.0 mm  
 Glob Top: Clear, Round: Ø 6.5 mm max.  
 Thickness: 0.58 mm max.  
 Pitch: 9.5 mm

Note: 1. The module dimensions listed refer to the dimensions of the exposed metal contact area. The actual dimensions of the module after excise or punching from the carrier tape are generally 0.4 mm greater in both directions (i.e. a punched M2 module will yield 13.0 x 11.8 mm).



## Atmel Headquarters

**Corporate Headquarters**  
2325 Orchard Parkway  
San Jose, CA 95131  
TEL (408) 441-0311  
FAX (408) 487-2600

### Europe

Atmel U.K., Ltd.  
Coliseum Business Centre  
Riverside Way  
Camberley, Surrey GU15 3YL  
England  
TEL (44) 1276-686-677  
FAX (44) 1276-686-697

### Asia

Atmel Asia, Ltd.  
Room 1219  
Chinachem Golden Plaza  
77 Mody Road Tsimhatsui  
East Kowloon  
Hong Kong  
TEL (852) 2721-9778  
FAX (852) 2722-1369

### Japan

Atmel Japan K.K.  
9F, Tonetsu Shinkawa Bldg.  
1-24-8 Shinkawa  
Chuo-ku, Tokyo 104-0033  
Japan  
TEL (81) 3-3523-3551  
FAX (81) 3-3523-7581

## Atmel Operations

**Atmel Colorado Springs**  
1150 E. Cheyenne Mtn. Blvd.  
Colorado Springs, CO 80906  
TEL (719) 576-3300  
FAX (719) 540-1759

### Atmel Rousset

Zone Industrielle  
13106 Rousset Cedex  
France  
TEL (33) 4-4253-6000  
FAX (33) 4-4253-6001

---

### ***Fax-on-Demand***

North America:  
1-(800) 292-8635  
International:  
1-(408) 441-0732

### ***e-mail***

literature@atmel.com

### ***Web Site***

<http://www.atmel.com>

### ***BBS***

1-(408) 436-4309

### **© Atmel Corporation 2000.**

Atmel Corporation makes no warranty for the use of its products, other than those expressly contained in the Company's standard warranty which is detailed in Atmel's Terms and Conditions located on the Company's web site. The Company assumes no responsibility for any errors which may appear in this document, reserves the right to change devices or specifications detailed herein at any time without notice, and does not make any commitment to update the information contained herein. No licenses to patents or other intellectual property of Atmel are granted by the Company in connection with the sale of Atmel products, expressly or by implication. Atmel's products are not authorized for use as critical components in life support devices or systems.

Marks bearing ® and/or ™ are registered trademarks and trademarks of Atmel Corporation.

Terms and product names in this document may be trademarks of others.



Printed on recycled paper.

1610A-05/00/xM