

N-Ch and P-Ch Fast Switching MOSFETs
General Description

The UM3301 is the highest performance trench N-ch and P-ch MOSFETs with extreme high cell density, which provide excellent RDSON and gate charge for most of the synchronous buck converter applications.

The UM3301 meet the RoHS and Green Product requirement, 100% EAS guaranteed with full function reliability approved.

Features

- Advanced high cell density Trench technology
- Super Low Gate Charge
- Excellent CdV/dt effect decline
- 100% EAS Guaranteed
- Green Device Available

Absolute Maximum Ratings

Symbol	Parameter	Rating		Units
		N-Channel	P-Channel	
V_{DS}	Drain-Source Voltage	30	-30	V
V_{GS}	Gate-Source Voltage	± 20	± 20	V
$I_D@T_C=25^\circ C$	Continuous Drain Current, $V_{GS} @ 10V^1$	10	-6	A
$I_D@T_C=100^\circ C$	Continuous Drain Current, $V_{GS} @ 10V^1$	6	-4	A
I_{DM}	Pulsed Drain Current ²	20	-12	A
EAS	Single Pulse Avalanche Energy ³	72	59	mJ
I_{AS}	Avalanche Current	21	-19	A
$P_D@T_C=25^\circ C$	Total Power Dissipation ⁴	2.5	2.08	W
T_{STG}	Storage Temperature Range	-55 to 150	-55 to 150	$^\circ C$
T_J	Operating Junction Temperature Range	-55 to 150	-55 to 150	$^\circ C$

Thermal Data

Symbol	Parameter	Typ.	Max.	Unit
$R_{\theta JA}$	Thermal Resistance Junction-Ambient ¹	---	85	$^\circ C/W$
$R_{\theta JC}$	Thermal Resistance Junction-Case ¹	---	50	$^\circ C/W$

Product Summary

BVDSS	RDSON	ID
30V	20m Ω	10A
-30V	45m Ω	6A

Applications

- Power management in half bridge and inverters
- DC-DC Converter
- Load Switch

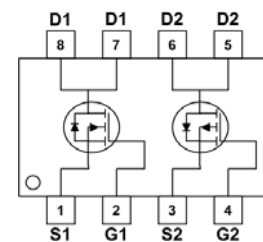
SOP8 Pin Configuration

N-Ch and P-Ch Fast Switching MOSFETs
N-Channel Electrical Characteristics ($T_J=25\text{ }^\circ\text{C}$, unless otherwise noted)

Symbol	Parameter	Conditions	Min.	Typ.	Max.	Unit
BV_{DSS}	Drain-Source Breakdown Voltage	$V_{GS}=0V, I_D=250\mu A$	30	---	---	V
$\Delta BV_{DSS}/\Delta T_J$	BVDSS Temperature Coefficient	Reference to 25°C , $I_D=1\text{mA}$	---	0.034	---	V/ $^\circ\text{C}$
$R_{DS(ON)}$	Static Drain-Source On-Resistance ²	$V_{GS}=10V, I_D=10A$	---	15	20	m Ω
		$V_{GS}=4.5V, I_D=8A$	---	22	30	
$V_{GS(th)}$	Gate Threshold Voltage	$V_{GS}=V_{DS}, I_D=250\mu A$	1.0	1.5	2.5	V
$\Delta V_{GS(th)}$	$V_{GS(th)}$ Temperature Coefficient		---	-5.8	---	mV/ $^\circ\text{C}$
I_{DSS}	Drain-Source Leakage Current	$V_{DS}=30V, V_{GS}=0V, T_J=25^\circ\text{C}$	---	---	1	μA
		$V_{DS}=30V, V_{GS}=0V, T_J=55^\circ\text{C}$	---	---	5	
I_{GSS}	Gate-Source Leakage Current	$V_{GS}=\pm 20V, V_{DS}=0V$	---	---	± 100	nA
g_{fs}	Forward Transconductance	$V_{DS}=15V, I_D=10A$	---	10	---	S
R_g	Gate Resistance	$V_{DS}=24V, V_{GS}=0V, f=1\text{MHz}$	---	2.5	---	Ω
Q_g	Total Gate Charge (4.5V)	$V_{DS}=20V, V_{GS}=4.5V, I_D=10A$	---	7.2	---	nC
Q_{gs}	Gate-Source Charge		---	1.4	---	
Q_{gd}	Gate-Drain Charge		---	2.2	---	
$T_{d(on)}$	Turn-On Delay Time	$V_{DD}=12V, V_{GS}=10V, R_G=3.3\Omega$ $I_D=5A$	---	4.1	---	ns
T_r	Rise Time		---	9.8	---	
$T_{d(off)}$	Turn-Off Delay Time		---	15.5	---	
T_f	Fall Time		---	6.0	---	
C_{iss}	Input Capacitance	$V_{DS}=25V, V_{GS}=0V, f=1\text{MHz}$	---	550	---	pF
C_{oss}	Output Capacitance		---	68	---	
C_{riss}	Reverse Transfer Capacitance		---	55	---	

Guaranteed Avalanche Characteristics

Symbol	Parameter	Conditions	Min.	Typ.	Max.	Unit
EAS	Single Pulse Avalanche Energy ⁵	$V_{DD}=25V, L=0.1\text{mH}, I_{AS}=10A$	16	---	---	mJ

Diode Characteristics

Symbol	Parameter	Conditions	Min.	Typ.	Max.	Unit
I_S	Continuous Source Current ^{1,6}	$V_G=V_D=0V$, Force Current	---	---	10	A
I_{SM}	Pulsed Source Current ^{2,6}		---	---	20	A
V_{SD}	Diode Forward Voltage ²	$V_{GS}=0V, I_S=5A, T_J=25^\circ\text{C}$	---	---	1.2	V

Note :

- The data tested by surface mounted on a 1 inch² FR-4 board with 20Z copper.
- The data tested by pulsed, pulse width $\leq 300\mu\text{s}$, duty cycle $\leq 2\%$
- The EAS data shows Max. rating. The test condition is $V_{DD}=25V, V_{GS}=10V, L=0.1\text{mH}, I_{AS}=21A$
- The power dissipation is limited by 150°C junction temperature
- The Min. value is 100% EAS tested guarantee.
- The data is theoretically the same as I_D and I_{DM} , in real applications, should be limited by total power dissipation.

N-Ch and P-Ch Fast Switching MOSFETs
P-Channel Electrical Characteristics ($T_J=25^\circ\text{C}$, unless otherwise noted)

Symbol	Parameter	Conditions	Min.	Typ.	Max.	Unit
BV_{DSS}	Drain-Source Breakdown Voltage	$V_{GS}=0V, I_D=-250\mu A$	-30	---	---	V
$\Delta BV_{DSS}/\Delta T_J$	BV_{DSS} Temperature Coefficient	Reference to 25°C , $I_D=-1\text{mA}$	---	-0.085	---	V/ $^\circ\text{C}$
$R_{DS(ON)}$	Static Drain-Source On-Resistance ²	$V_{GS}=-10V, I_D=-6A$	---	35	45	m Ω
		$V_{GS}=-4.5V, I_D=-3A$	---	65	85	
$V_{GS(th)}$	Gate Threshold Voltage	$V_{GS}=V_{DS}, I_D=-250\mu A$	-1.0	-1.5	-2.5	V
$\Delta V_{GS(th)}$	$V_{GS(th)}$ Temperature Coefficient		---	0.375	---	mV/ $^\circ\text{C}$
I_{DSS}	Drain-Source Leakage Current	$V_{DS}=-24V, V_{GS}=0V, T_J=25^\circ\text{C}$	---	---	1	μA
		$V_{DS}=-24V, V_{GS}=0V, T_J=55^\circ\text{C}$	---	---	5	
I_{GSS}	Gate-Source Leakage Current	$V_{GS}=\pm 20V, V_{DS}=0V$	---	---	± 100	nA
g_{fs}	Forward Transconductance	$V_{DS}=-10V, I_D=-6A$	---	6	---	S
Q_g	Total Gate Charge (-4.5V)	$V_{DS}=-20V, V_{GS}=-4.5V, I_D=-6A$	---	6.4	---	nC
Q_{gs}	Gate-Source Charge		---	2.7	---	
Q_{gd}	Gate-Drain Charge		---	3.1	---	
$T_{d(on)}$	Turn-On Delay Time	$V_{DD}=-12V, V_{GS}=-10V, R_G=3.3\Omega, I_D=-5A$	---	9	---	ns
T_r	Rise Time		---	16.6	---	
$T_{d(off)}$	Turn-Off Delay Time		---	21	---	
T_f	Fall Time		---	21.6	---	
C_{iss}	Input Capacitance	$V_{DS}=-25V, V_{GS}=0V, f=1\text{MHz}$	---	645	---	pF
C_{oss}	Output Capacitance		---	272	---	
C_{rss}	Reverse Transfer Capacitance		---	105	---	

Guaranteed Avalanche Characteristics

Symbol	Parameter	Conditions	Min.	Typ.	Max.	Unit
EAS	Single Pulse Avalanche Energy ⁵	$V_{DD}=-25V, L=0.1\text{mH}, I_{AS}=-10A$	16	---	---	mJ

Diode Characteristics

Symbol	Parameter	Conditions	Min.	Typ.	Max.	Unit
I_S	Continuous Source Current ^{1,6}	$V_G=V_D=0V$, Force Current	---	---	-6	A
I_{SM}	Pulsed Source Current ^{2,6}		---	---	-12	A
V_{SD}	Diode Forward Voltage ²	$V_{GS}=0V, I_S=-6A, T_J=25^\circ\text{C}$	---	---	-1.2	V

Note :

- The data tested by surface mounted on a 1 inch² FR-4 board with 2OZ copper.
- The data tested by pulsed, pulse width $\leq 300\mu\text{s}$, duty cycle $\leq 2\%$
- The EAS data shows Max. rating. The test condition is $V_{DD}=-25V, V_{GS}=-10V, L=0.1\text{mH}, I_{AS}=-19A$
- The power dissipation is limited by 150°C junction temperature
- The Min. value is 100% EAS tested guarantee.
- The data is theoretically the same as I_D and I_{DM} , in real applications, should be limited by total power dissipation.

N-Ch and P-Ch Fast Switching MOSFETs

N-Channel Typical Characteristics

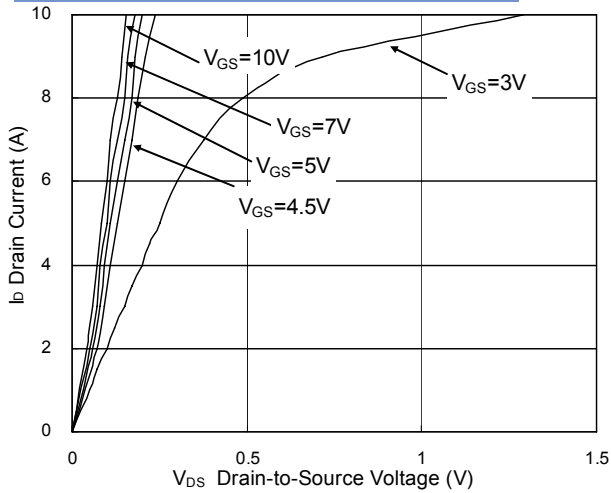

Fig.1 Typical Output Characteristics

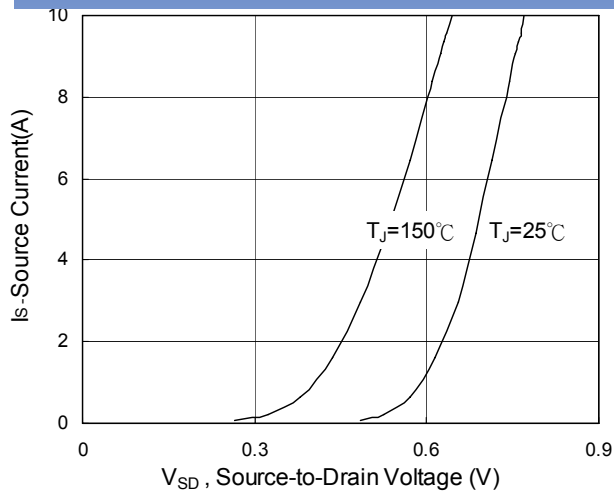

Fig.3 Forward Characteristics of Reverse

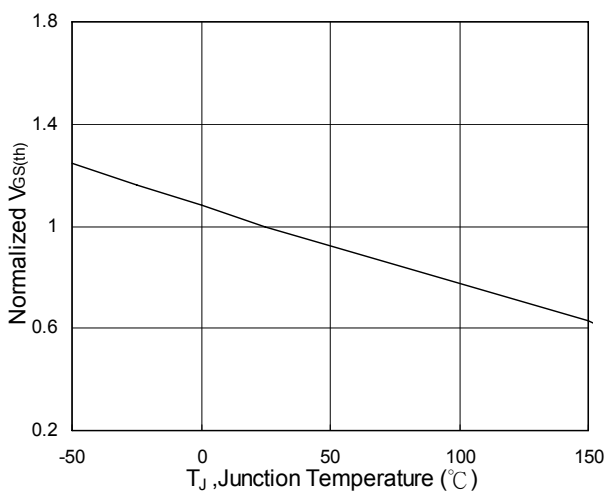

Fig.5 $V_{GS(th)}$ vs. T_J

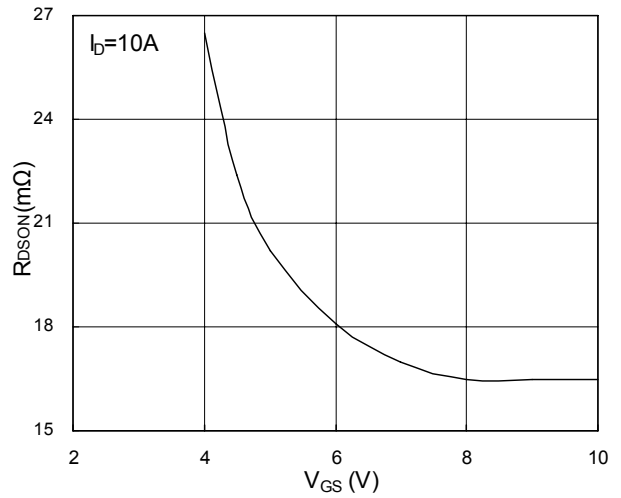

Fig.2 On-Resistance vs. G-S Voltage

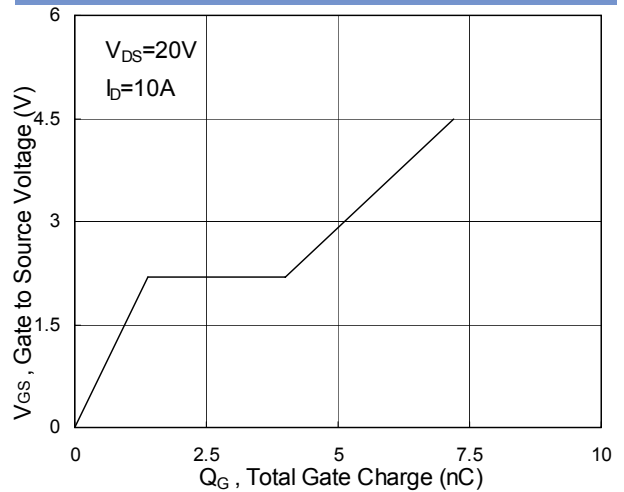

Fig.4 Gate-charge Characteristics

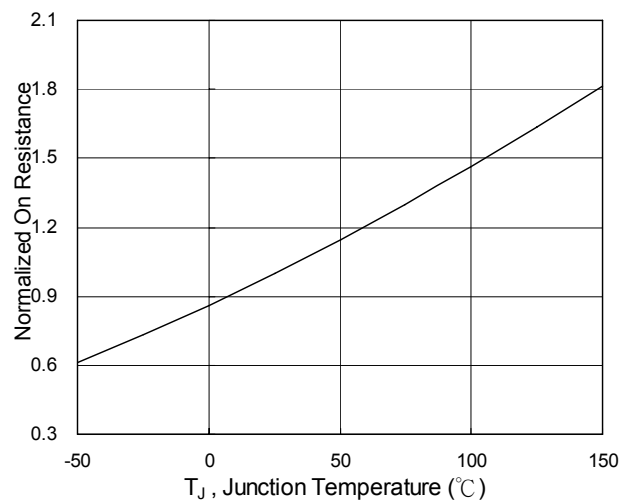

Fig.6 Normalized $R_{DS(on)}$ vs. T_J

N-Ch and P-Ch Fast Switching MOSFETs

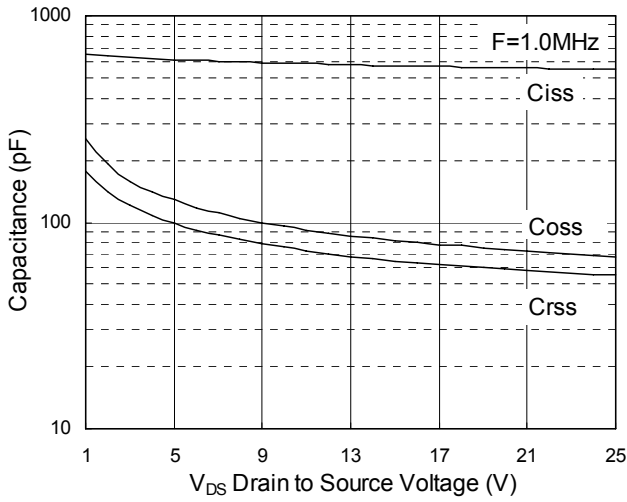

Fig.7 Capacitance

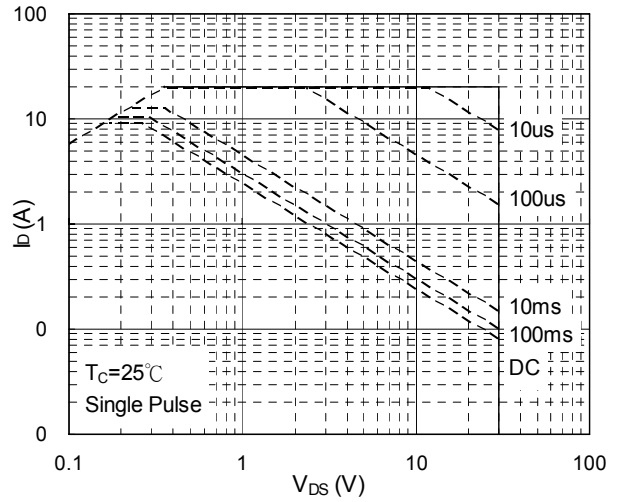

Fig.8 Safe Operating Area

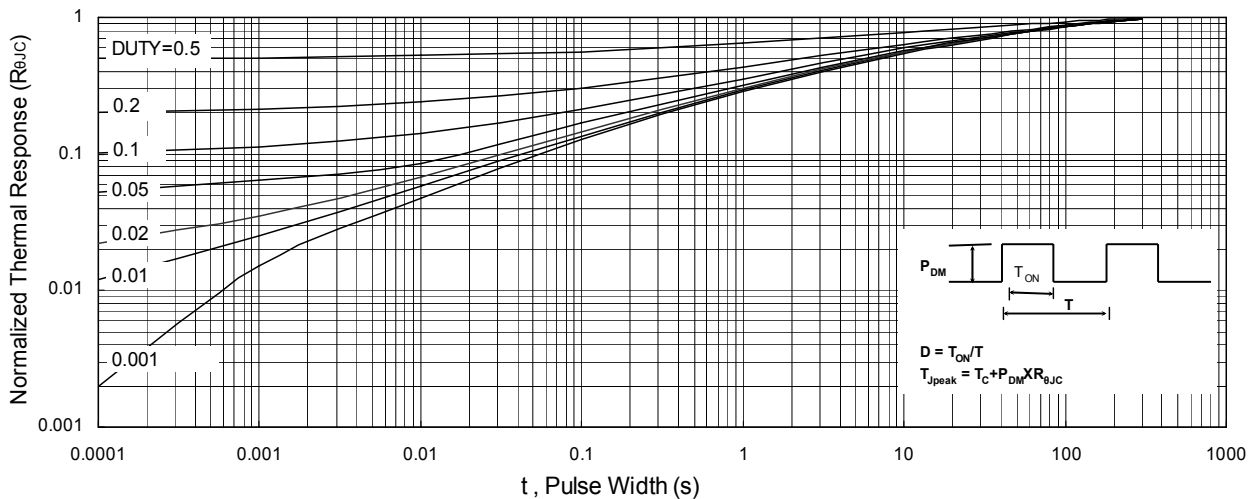

Fig.9 Normalized Maximum Transient Thermal Impedance

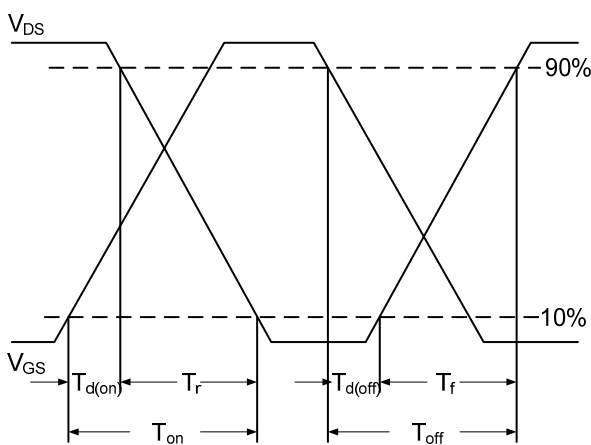

Fig.10 Switching Time Waveform

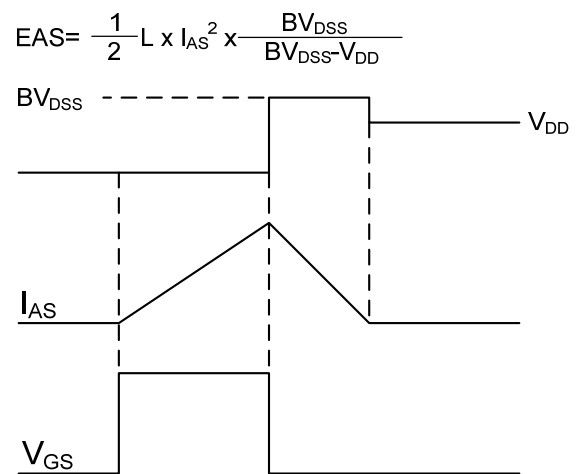

Fig.11 Unclamped Inductive Waveform

N-Ch and P-Ch Fast Switching MOSFETs

P-Channel Typical Characteristics

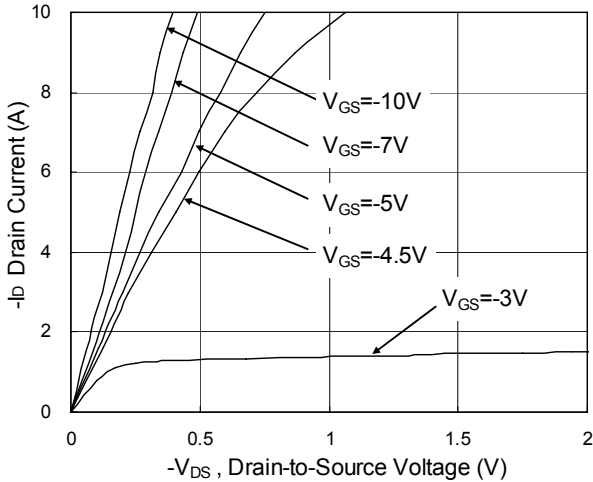

Fig.1 Typical Output Characteristics

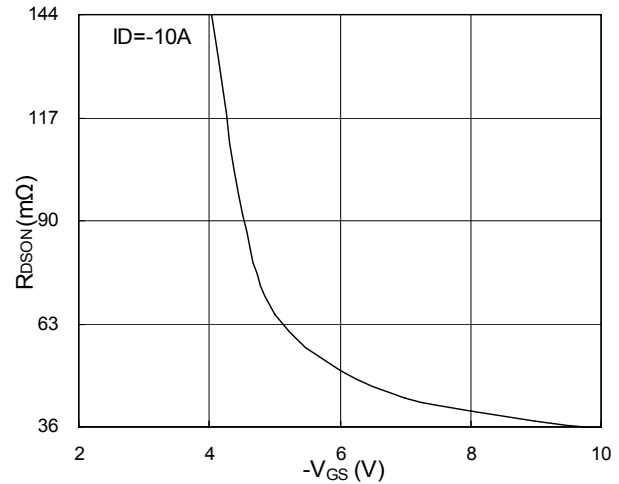

Fig.2 On-Resistance vs. Gate-Source

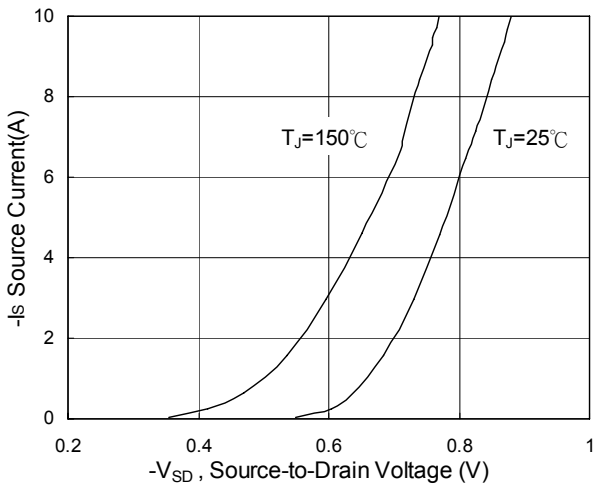

Fig.3 Forward Characteristics of Reverse

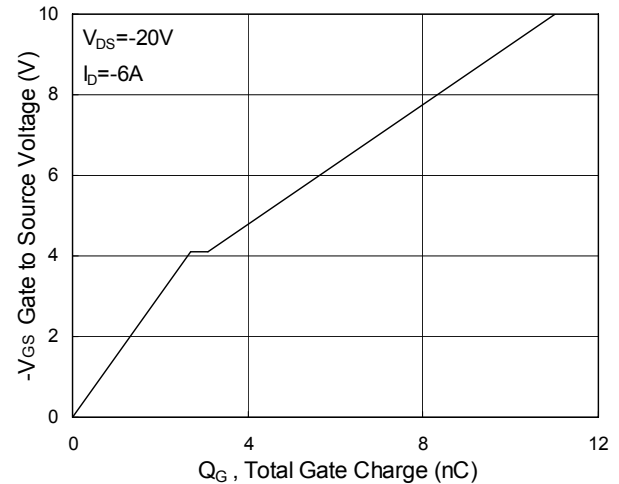

Fig.4 Gate-charge Characteristics

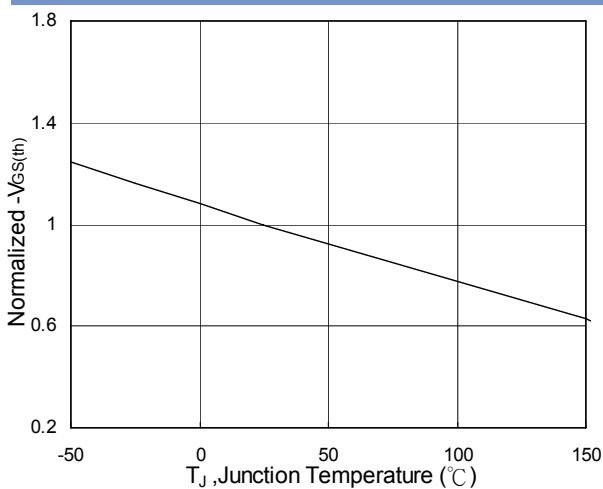

Fig.5 Normalized $V_{GS(th)}$ vs. T_J

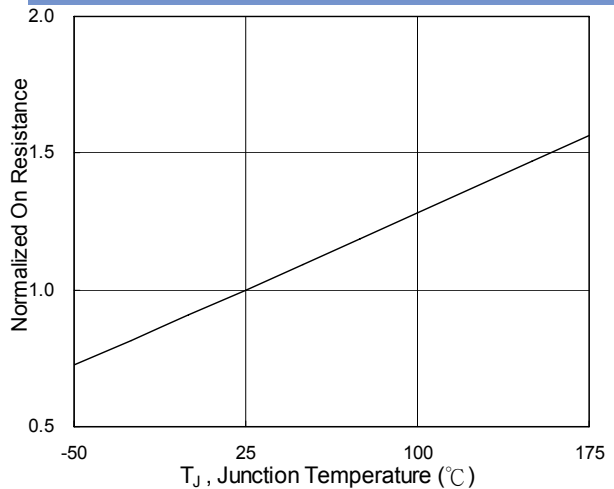

Fig.6 Normalized $R_{DS(on)}$ vs. T_J

N-Ch and P-Ch Fast Switching MOSFETs

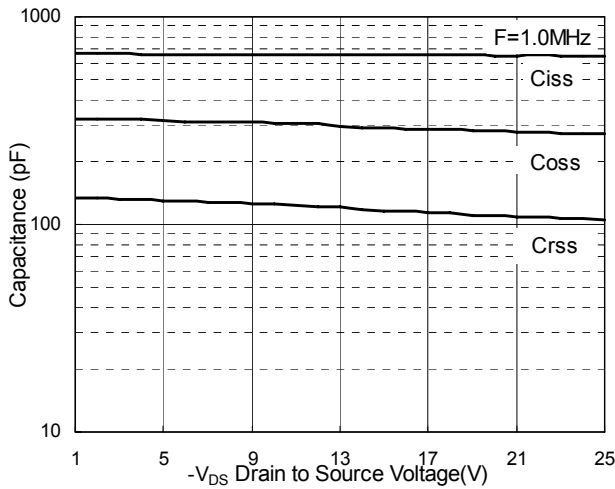

Fig.7 Capacitance

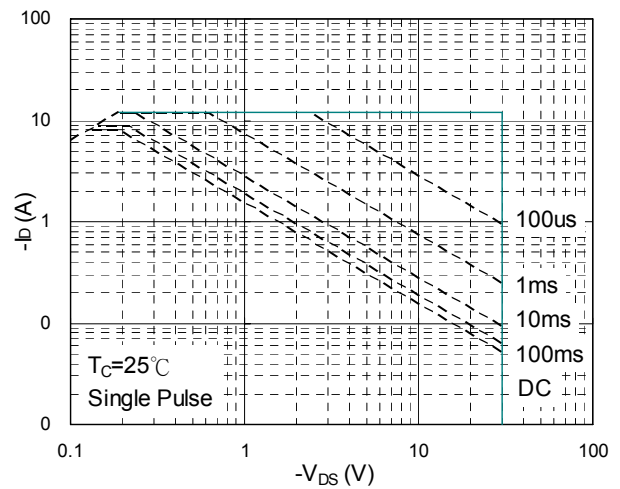

Fig.8 Safe Operating Area

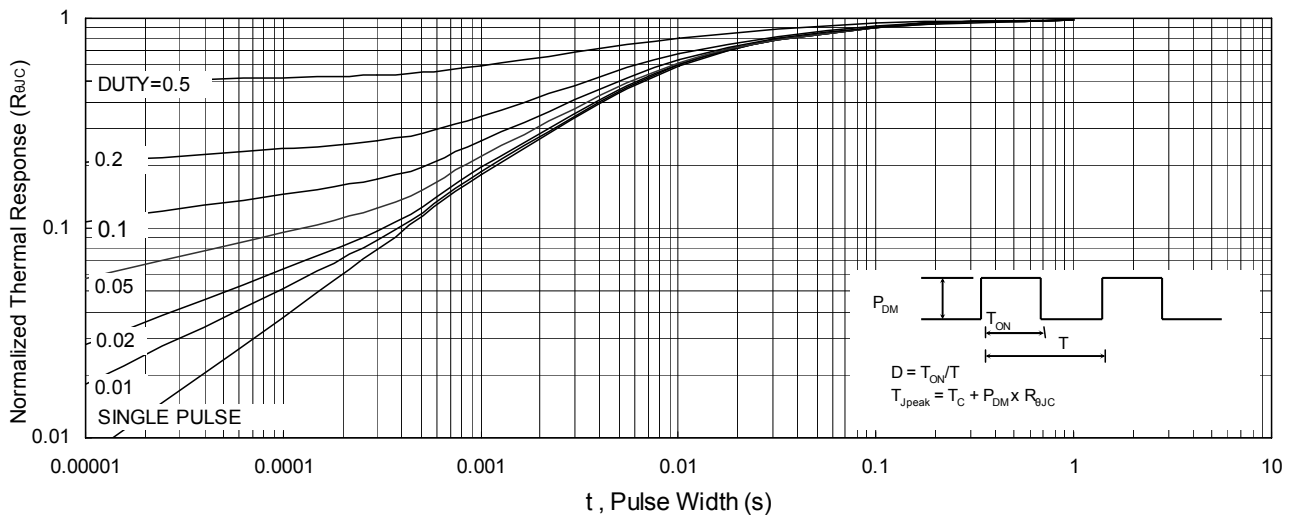

Fig.9 Normalized Maximum Transient Thermal Impedance

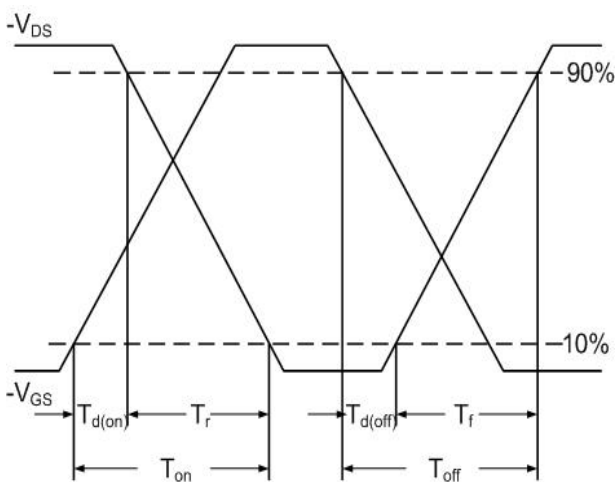

Fig.10 Switching Time Waveform

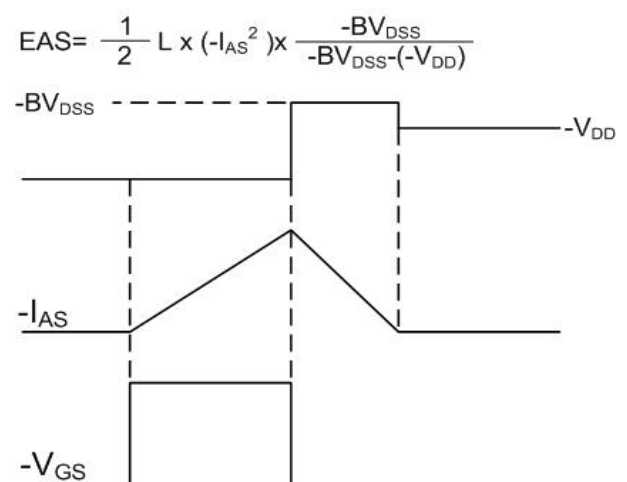

Fig.11 Unclamped Inductive Waveform