

Features

- 100V/80A
 $R_{DS(ON)}=10m\Omega(Typ.) @ V_{GS}=10V$
- Ultra Low On-Resistance
- Exceptional dv/dt capability
- Fast Switching and Fully Avalanche Rated
- 100% avalanche tested
- Lead Free and Green Available

Applications

- Switching Application Systems

Pin Description

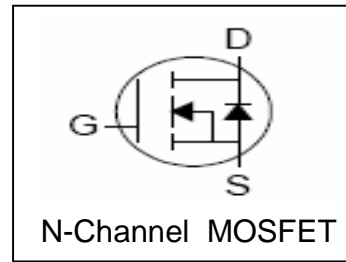
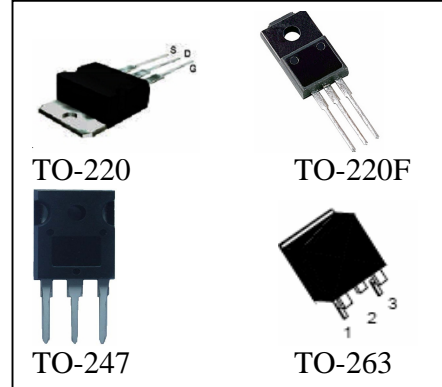

Absolute Maximum Ratings

Symbol	Parameter	Rating	Unit
Common Ratings ($T_A=25^\circ\text{C}$ Unless Otherwise Noted)			
V_{DSS}	Drain-Source Voltage	100	V
V_{GSS}	Gate-Source Voltage	± 25	
T_J	Maximum Junction Temperature	175	$^\circ\text{C}$
T_{STG}	Storage Temperature Range	-55 to 175	$^\circ\text{C}$
I_S	Diode Continuous Forward Current	$T_C=25^\circ\text{C}$ 80	A
Mounted on Large Heat Sink			
I_{DP}	300 μs Pulsed Drain Current Tested	$T_C=25^\circ\text{C}$ 350	A
I_D	Continue Drain Current	$T_C=25^\circ\text{C}$ 80 ^①	
		$T_C=100^\circ\text{C}$ 75	
P_D	Maximum Power Dissipation	$T_C=25^\circ\text{C}$ 300	W
		$T_C=100^\circ\text{C}$ 150	
$R_{\theta JC}$	Thermal Resistance -Junction to Case	0.5	$^\circ\text{C/W}$
$R_{\theta JA}$	Thermal Resistance-Junction to Ambient	62.5	
Drain-Source Avalanche Ratings			
E_{AS}	Avalanche Energy ,Single Pulsed	800	mJ

Electrical Characteristics ($T_A=25^\circ\text{C}$ Unless Otherwise Noted)

Symbol	Parameter	Test Condition	RU1088			Unit
			Min.	Typ.	Max.	
Static Characteristics						
BV_{DSS}	Drain-Source Breakdown Voltage	$V_{GS}=0V, I_{DS}=250\mu A$	100			V
I_{DSS}	Zero Gate Voltage Drain Current	$V_{DS}=100V, V_{GS}=0V$ $T_J=85^\circ\text{C}$			1	μA
					30	
$V_{GS(th)}$	Gate Threshold Voltage	$V_{DS}=V_{GS}, I_{DS}=250\mu A$	2	3	4	V
I_{GSS}	Gate Leakage Current	$V_{GS}=\pm 25V, V_{DS}=0V$			± 100	nA
$R_{DS(ON)}^{(2)}$	Drain-Source On-state Resistance	$V_{GS}=10V, I_{DS}=40A$		10	13	$m\Omega$
Diode Characteristics						
$V_{SD}^{(2)}$	Diode Forward Voltage	$I_{SD}=40A, V_{GS}=0V$		0.8	1.3	V
t_{rr}	Reverse Recovery Time	$I_{SD}=40A, di_{SD}/dt=100A/\mu s$		90		ns
q_{rr}	Reverse Recovery Charge			180		nC
Dynamic Characteristics ⁽³⁾						
R_G	Gate Resistance	$V_{GS}=0V, V_{DS}=0V, F=1\text{MHz}$		1.5		Ω
C_{iss}	Input Capacitance	$V_{GS}=0V,$ $V_{DS}=30V,$ Frequency=1.0MHz		3600		pF
C_{oss}	Output Capacitance			510		
C_{riss}	Reverse Transfer Capacitance			210		
$t_{d(ON)}$	Turn-on Delay Time	$V_{DD}=35V, R_L=35\Omega,$ $I_{DS}=1A, V_{GEN}=10V,$ $R_G=6\Omega$		25	50	ns
t_r	Turn-on Rise Time			13	25	
$t_{d(OFF)}$	Turn-off Delay Time			80	150	
t_f	Turn-off Fall Time			72	130	
Gate Charge Characteristics ⁽³⁾						
Q_g	Total Gate Charge	$V_{DS}=60V, V_{GS}=10V,$ $I_{DS}=80A$		85	120	nC
Q_{gs}	Gate-Source Charge			20		
Q_{gd}	Gate-Drain Charge			30		

- Notes: ① Current limited by wire bond.
 ② Pulse test ; Pulse width $\leq 300\mu s$, duty cycle $\leq 2\%$.
 ③ Guaranteed by design, not subject to production testing.

Typical Characteristics

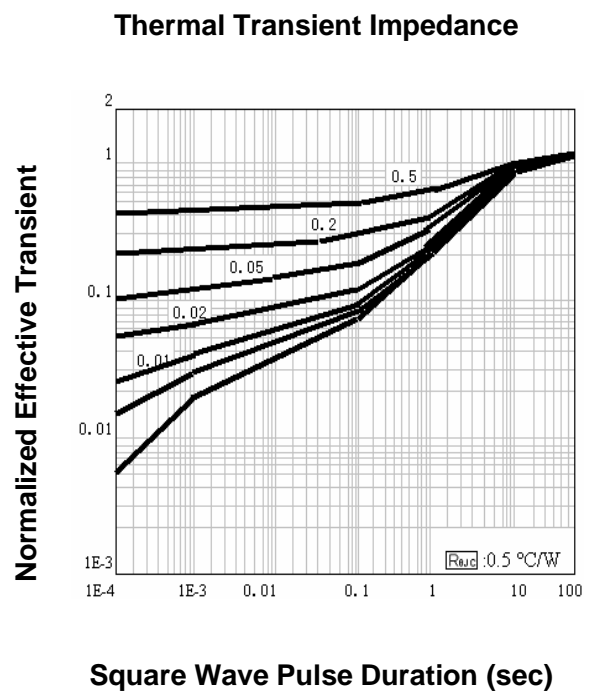
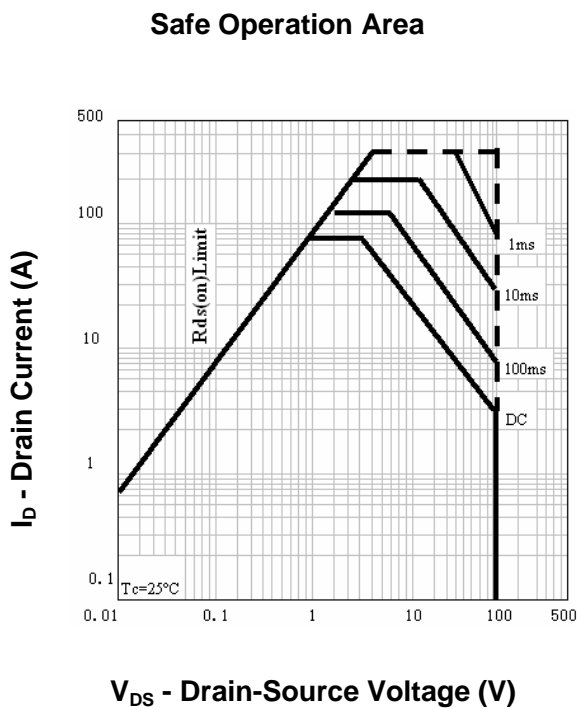
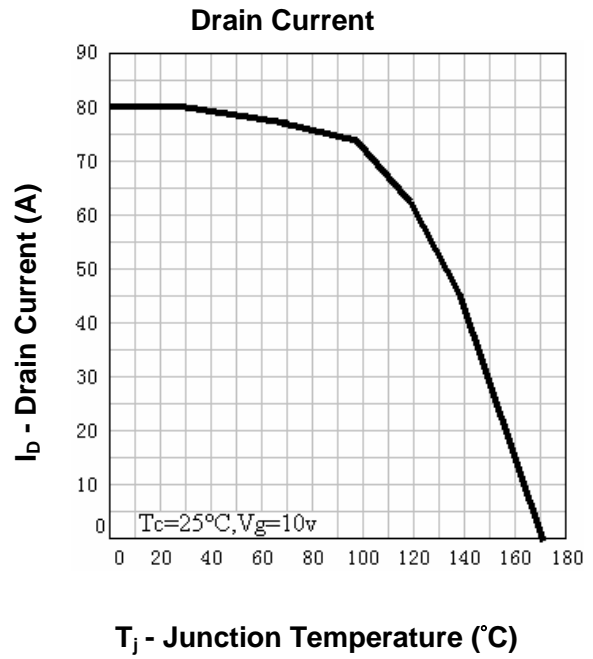
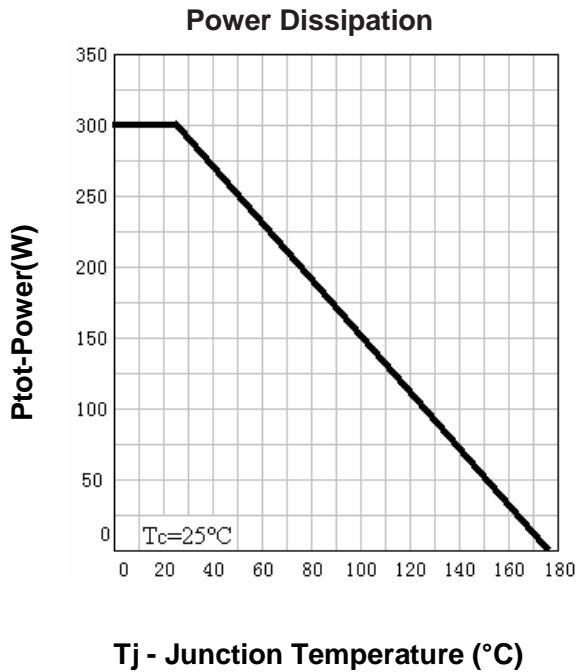

Typical Characteristics

Output Characteristics

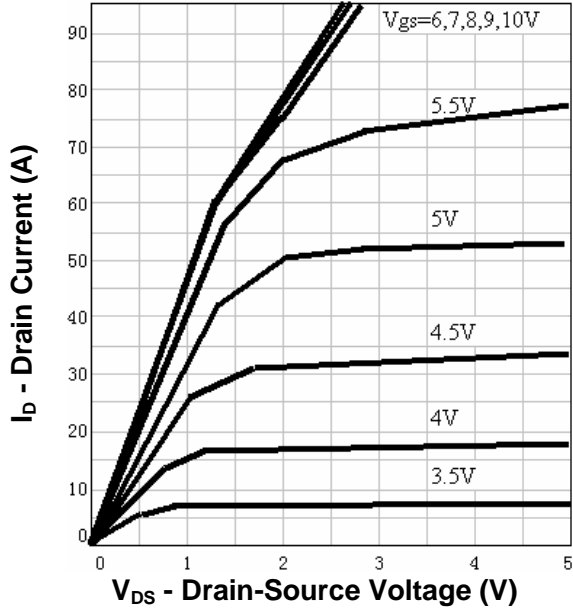

Drain-Source On Resistance

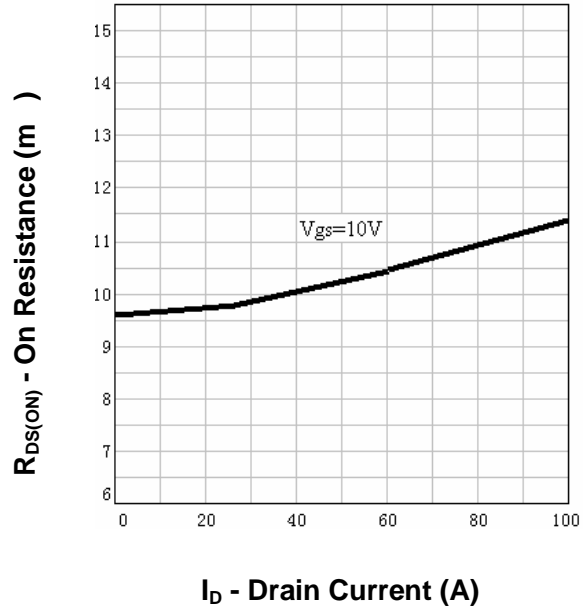

Drain-Source On Resistance

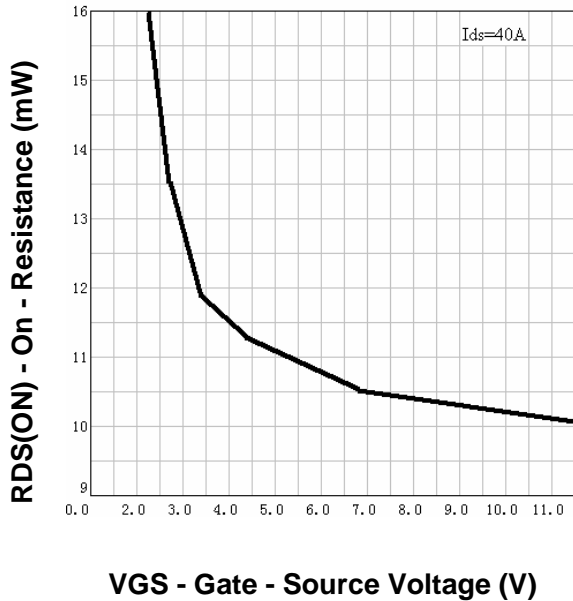

Gate Threshold Voltage

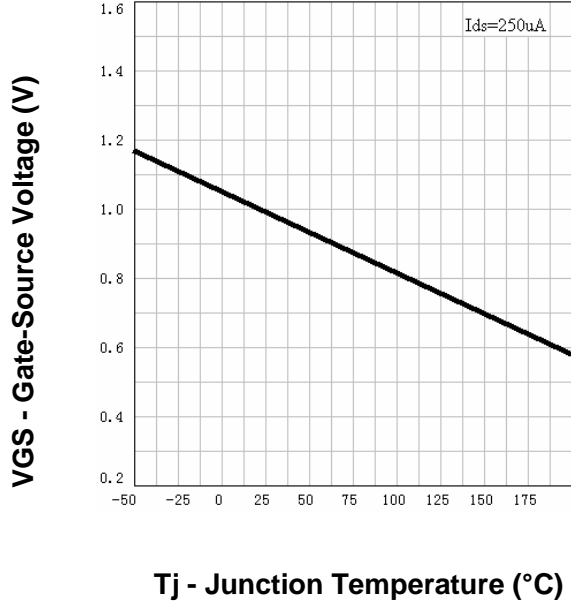

Typical Characteristics

Drain-Source On Resistance

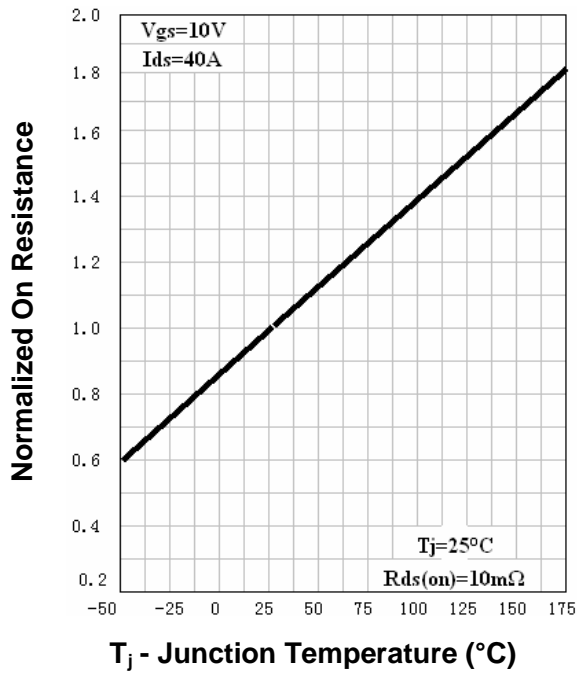

Source-Drain Diode Forward

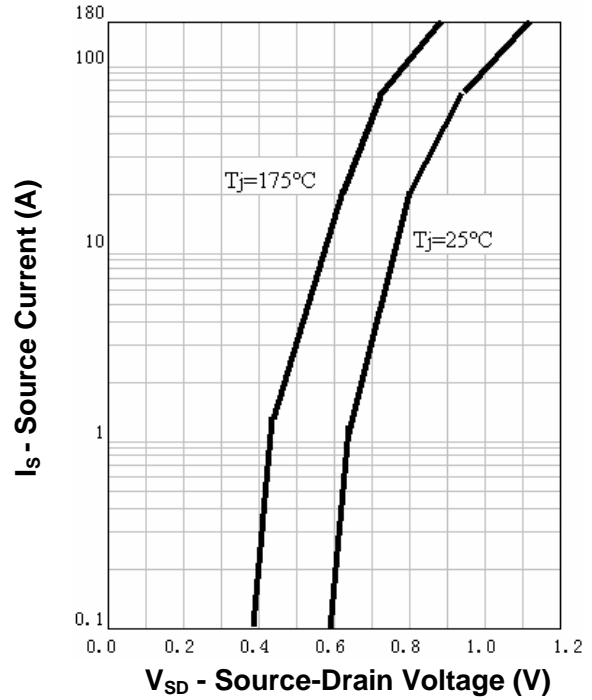

Capacitance

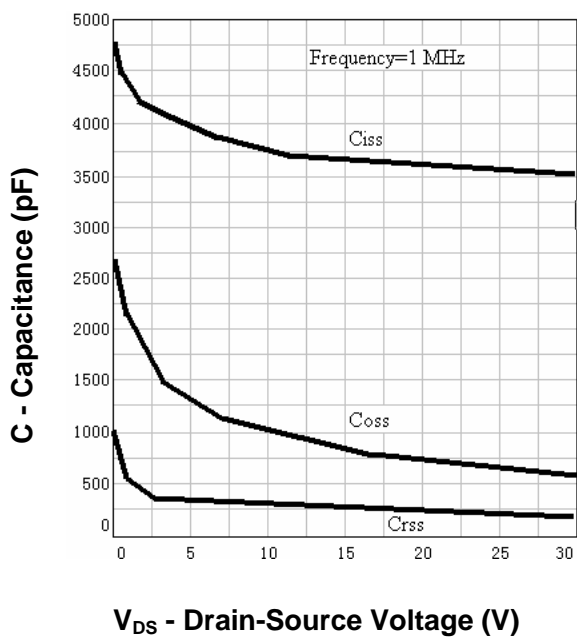

Gate Charge

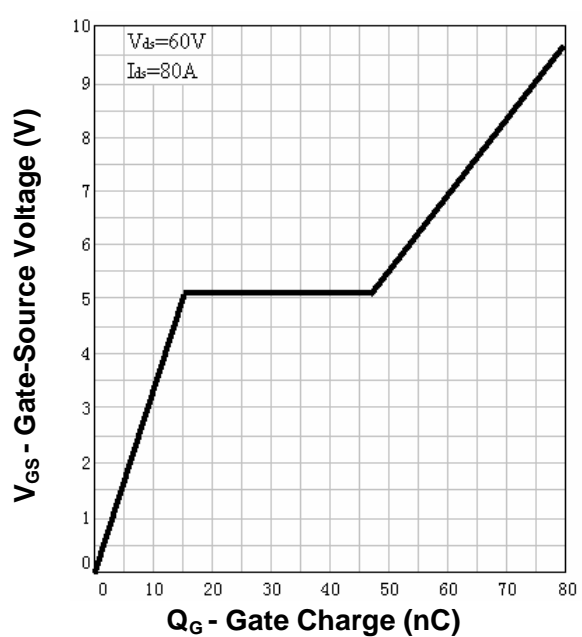

Avalanche Test Circuit and Waveforms

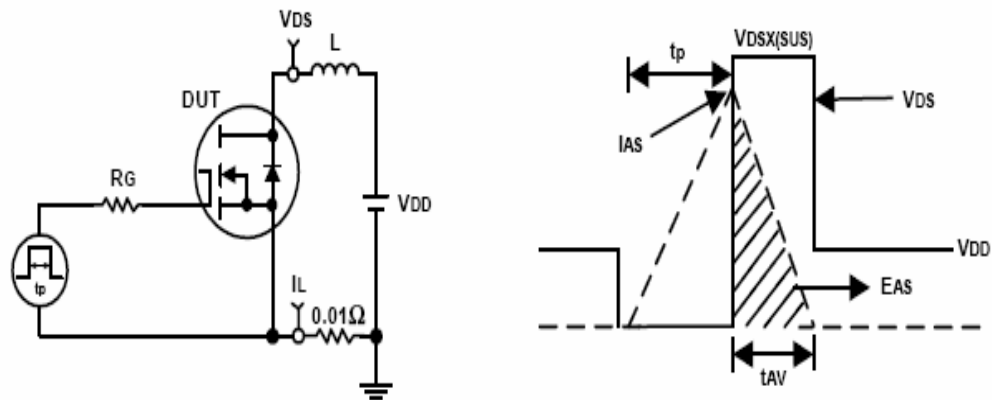

Switching Time Test Circuit and Waveforms

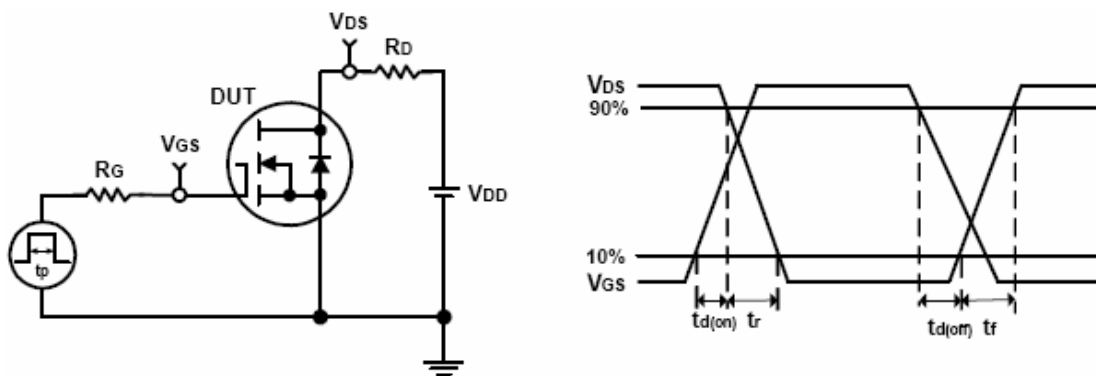

Ordering and Marking Information**RU1088****Package (Available)**

R : TO-220; S: TO-263 ; Q: TO-247

Operating Temperature Range

C : -55 to 175 °C

Assembly Material

G : Green & Lead Free Device

Packaging

T : TUBE

TR : Tape & Reel

Package Information

TO-220FB-3L



SYMBOL	MM			INCH			SYMBOL	MM			INCH		
	MIN	NOM	MAX	MIN	NOM	MAX		MIN	NOM	MAX	MIN	NOM	MAX
A	4.40	4.57	4.70	0.173	0.180	0.185	$\phi p1$	1.40	1.50	1.60	0.055	0.059	0.063
A1	1.27	1.30	1.33	0.050	0.051	0.052	e	2.54BSC			0.1BSC		
A2	2.35	2.40	2.50	0.093	0.094	0.098	e1	5.08BSC			0.2BSC		
b	0.77	-	0.90	0.030	-	0.035	H1	6.40	6.50	6.60	0.252	0.256	0.260
b2	1.23	-	1.36	0.048	-	0.054	L	12.75	-	13.17	0.502	-	0.519
C	0.48	0.50	0.52	0.019	0.020	0.021	L1	-	-	3.95	-	-	0.156
D	15.40	15.60	15.80	0.606	0.614	0.622	L2	2.50REF.			0.098REF.		
D1	9.00	9.10	9.20	0.354	0.358	0.362	ϕp	3.57	3.60	3.63	0.141	0.142	0.143
DEP	0.05	0.10	0.20	0.002	0.004	0.008	Q	2.73	2.80	2.87	0.107	0.110	0.113
E	9.70	9.90	10.10	0.382	0.389	0.398	$\theta 1$	5°	7°	9°	5°	7°	9°
E1	-	8.70	-	-	0.343	-	$\theta 2$	1°	3°	5°	1°	3°	5°
E2	9.80	10.00	10.20	0.386	0.394	0.401							

ALL DIMENSIONS REFER TO JEDEC STANDARD
DO NOT INCLUDE MOLD FLASH OR PROTRUSIONS

TO-263-2L

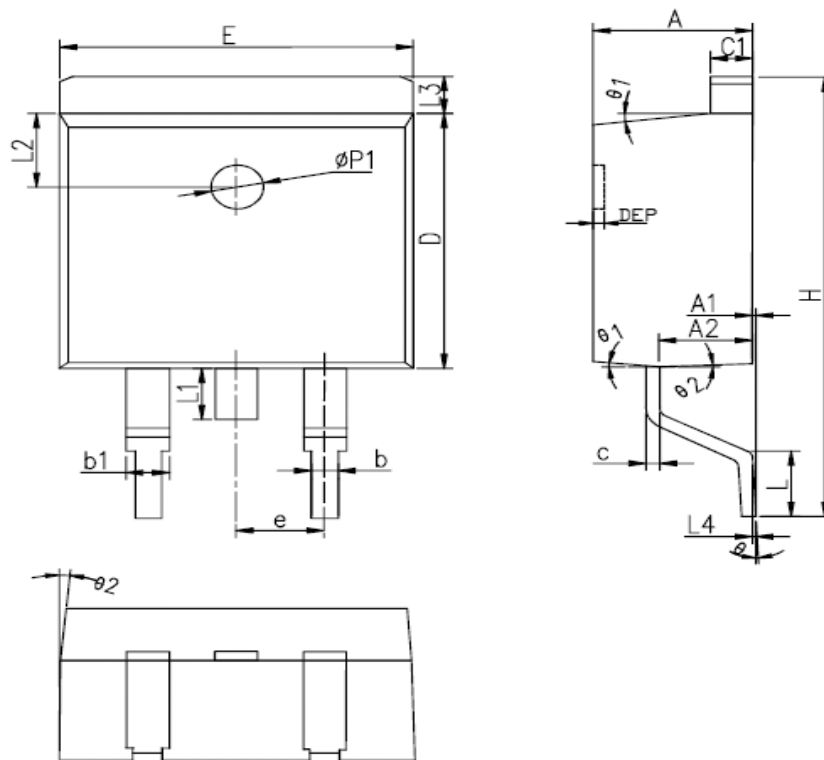

SYMBOL	MM			INCH			SYMBOL	MM			INCH		
	MIN	NOM	MAX	MIN	NOM	MAX		MIN	NOM	MAX	MIN	NOM	MAX
A	4.40	4.57	4.70	0.173	0.180	0.185	L	2.00	2.30	2.60	0.079	0.090	0.102
A1	0	0.10	0.25	0	0.004	0.010	L3	1.17	1.27	1.40	0.046	0.050	0.055
A2	2.59	2.69	2.79	0.102	0.106	0.110	L1	-	-	1.70	-	-	0.067
b	0.77	-	0.90	0.030	-	0.035	L4	0.25BSC			0.01BSC		
b1	1.23	-	1.36	0.048	-	0.052	L2	2.50REF.			0.098REF.		
c	0.34	-	0.47	0.013	-	0.019	θ	0°	-	8°	0°	-	8°
C1	1.22	-	1.32	0.048	-	0.052	θ 1	5°	7°	9°	5°	7°	9°
D	8.60	8.70	8.80	0.338	0.343	0.346	θ 2	1°	3°	5°	1°	3°	5°
E	10.00	10.16	10.26	0.394	0.4	0.404	DEP	0.05	0.10	0.20	0.002	0.004	0.008
e	2.54BSC			0.1BSC			Øp1	1.40	1.50	1.60	0.055	0.059	0.063
H	14.70	15.10	15.50	0.579	0.594	0.610							

**ALL DIMENSIONS REFER TO JEDEC STANDARD
DO NOT INCLUDE MOLD FLASH OR PROTRUSIONS**

TO-247

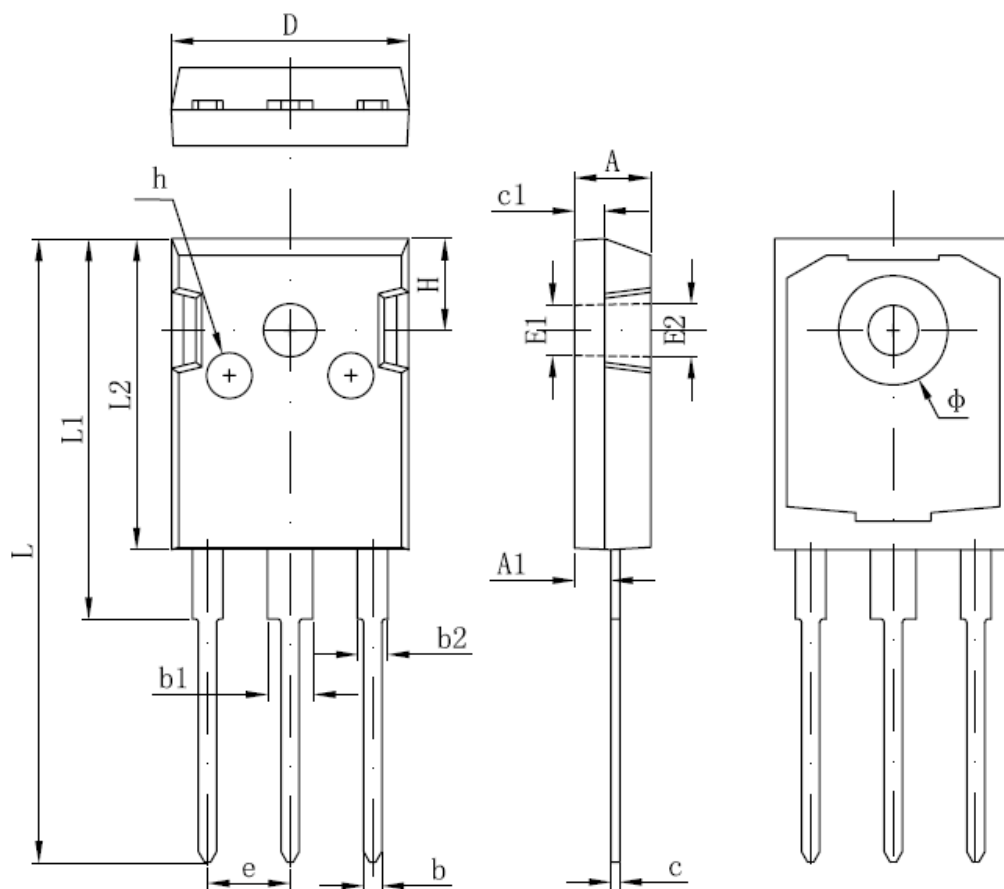

SYMBOL	MM		INCH		SYMBOL	MM		INCH	
	MIN	MAX	MIN	MAX		MIN	MAX	MIN	MAX
A	4.850	5.150	0,191	0,200	E2	3.600 REF		0.142 REF	
A1	2.200	2.600	0,087	0,102	L	40.900	41.300	1,610	1,626
B	1.000	1.400	0,039	0,055	L1	24.800	25.100	0,976	0,988
b1	2.800	3.200	0,110	0,126	L2	20.300	20.600	0,799	0,811
b2	1.800	2.200	0,071	0,087	Φ	7.100	7.300	0,280	0,287
c	0.500	0.700	0,020	0,028	e	5.450 TYP		0.215 TYP	
c1	1.900	2.100	0,075	0,083	H	5.980 REF.		0.235 REF.	
D	15.450	15.750	0,608	0,620	h	0.000	0.300	0,000	0,012
E1	3.500 REF.		0.138 REF.						

**ALL DIMENSIONS REFER TO JEDEC STANDARD
DO NOT INCLUDE MOLD FLASH OR PROTRUSIONS**

Customer Service

Worldwide Sales and Service:

Sales@ruichips.com

Technical Support:

Technical@ruichips.com

Investor Relations Contacts:

Investor@ruichips.com

Marcom Contact:

Marcom@ruichips.com

Editorial Contact:

Editorial@ruichips.com

HR Contact:

HR@ruichips.com

Legal Contact:

Legal@ruichips.com

Shen Zhen RUICHIPS Semiconductor CO., LTD

Room 501, the 5floor An Tong Industrial Building,
NO.207 Mei Hua Road Fu Tian Area Shen Zhen City, CHINA

TEL: (86-755) 8311-5334

FAX: (86-755) 8311-4278

E-mail: Sales-SZ@ruichips.com