

2-line IPAD™ EMI filter and ESD protection

Features

- 2-line symmetrical low-pass filter
- Lead-free package
- Very low PCB space consuming: <math>< 1.5 \text{ mm}^2</math>
- Very thin package: 0.65 mm
- High efficiency in ESD suppression
IEC 61000-4-2 level 4
- High reliability offered by monolithic integration
- High reduction of parasitic elements through integration and wafer level packaging

Complies with the following standards

- IEC 61000-4-2 level 4:
 - 15 kV (air discharge)
 - 8 kV (contact discharge)

Application

- Mobile phones (differential microphone filtering and ESD protection)

Description

The EMIF02-MIC06F3 is a highly integrated device designed to suppress EMI/RFI noise for dual microphone line filtering.

The EMIF02-MIC06F3 Flip-Chip packaging means the package size is equal to the die size. That's why EMIF02-MIC06F3 is a very small device.

Additionally, this filter includes an ESD protection circuitry which prevents damage to the application when subjected to ESD surges up to 15 kV.

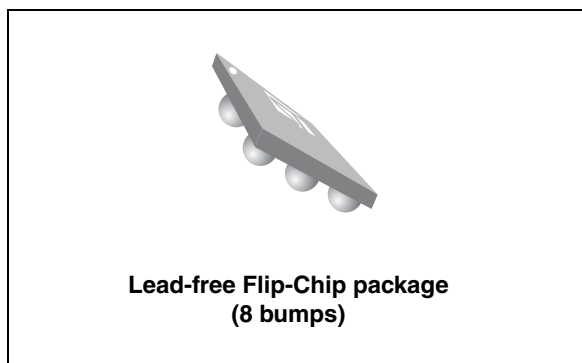
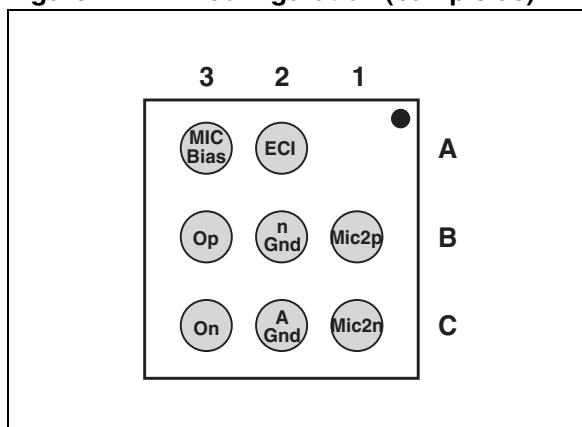

Figure 1. Pin configuration (bump side)



TM: IPAD is a trademark of STMicroelectronics.

1 Characteristics

Figure 2. Configuration

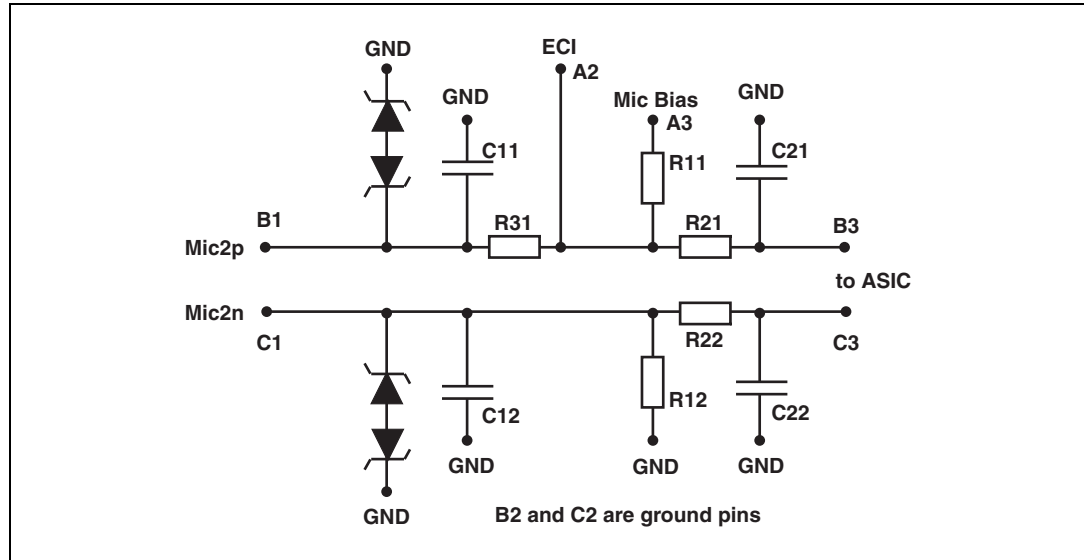

ECI pin connection

The ECI pin (enhancement control interface) is an input pin for the audio pre-amplifier chip which detects the voltage of the microphone line MIC2P in case the user presses the on-hook/off-hook button on the headset. When the user selects off-hook using the headset button, the MIC2P is shorted to MIC2N which is grounded. If your design does not support the ECI feature, the ECI pin must be left open (not connected).

Table 1. Absolute ratings (limiting values)

Symbol	Parameter and test conditions	Value	Unit
V_{PP}	Pins B1 and C1: ESD discharge IEC 61000-4-2, level 4 air discharge contact discharge	15 8	kV
	Pins A2, A3, B2, B3, C2, C3: ESD discharge IEC 61000-4-2, level 1 air discharge contact discharge	2 2	
P_D	Power dissipation at $T_{amb} = 25\text{ °C}$	60	mW
T_j	Maximum junction temperature	125	°C
T_{op}	Operating temperature range	- 40 to + 85	°C
T_{stg}	Storage temperature range	- 55 to + 150	°C

Figure 3. Electrical characteristics (definitions)

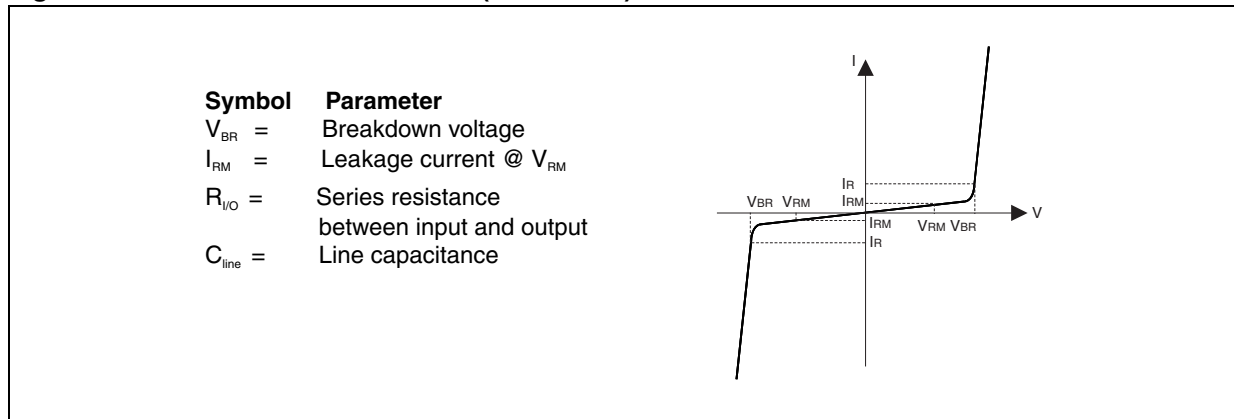

Table 2. Electrical characteristics - values ($T_{amb} = 25\text{ }^{\circ}\text{C}$)

Symbol	Test conditions	Min.	Typ.	Max.	Unit
V_{BR}	$I_R = 1\text{ mA}$	14			V
I_{RM}	$V_{RM} = 3\text{ V per line}$			100	nA
R_{11}		1.9	2	2.1	k Ω
R_{12}		0.8	1	1.2	k Ω
R_{21}, R_{22}		1.76	2.2	2.64	k Ω
R_{31}		20	25	30	Ω
C_{11}, C_{12}	$V_R = 0\text{ V}$		0.8	1	nF
C_{21}, C_{22}	$V_R = 0\text{ V}$	1	1.25		nF

Figure 4. Attenuation simulation with 1 k Ω input and 10 k Ω output

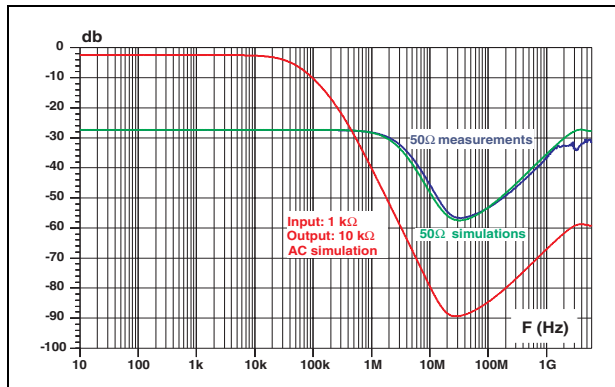

Figure 5. Analog crosstalk measurement

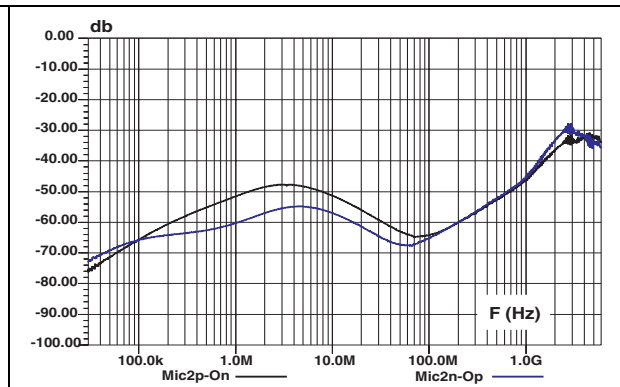

Figure 6. ESD response to IEC 61000-4-2 (+15 kV air discharge) on Mic2p

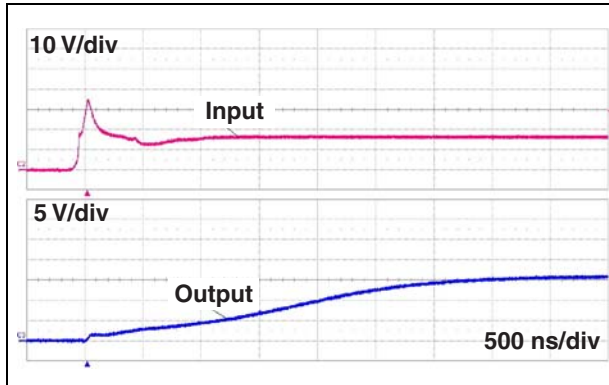

Figure 7. ESD response to IEC 61000-4-2 (-15 kV air discharge) on Mic2p

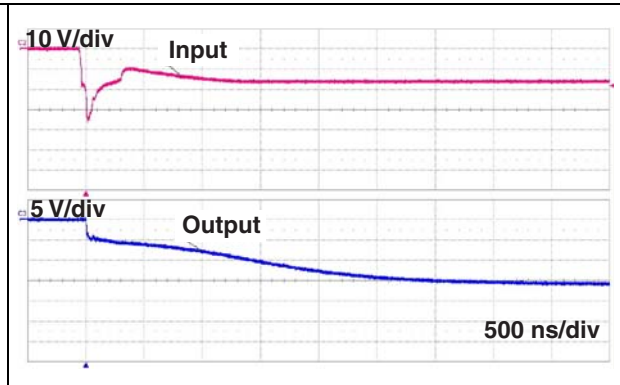

Figure 8. ESD response to IEC 61000-4-2 (+15 kV air discharge) on Mic2n

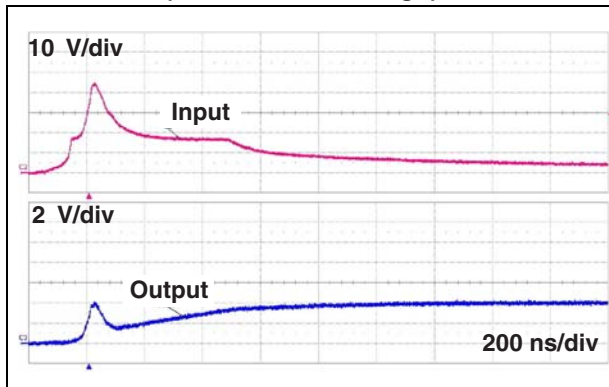

Figure 9. ESD response to IEC 61000-4-2 (-15 kV air discharge) on Mic2n

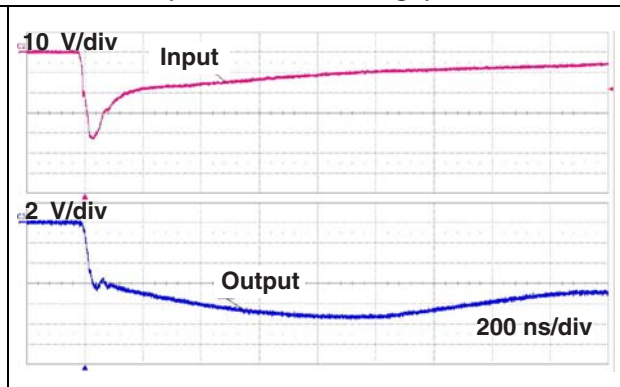
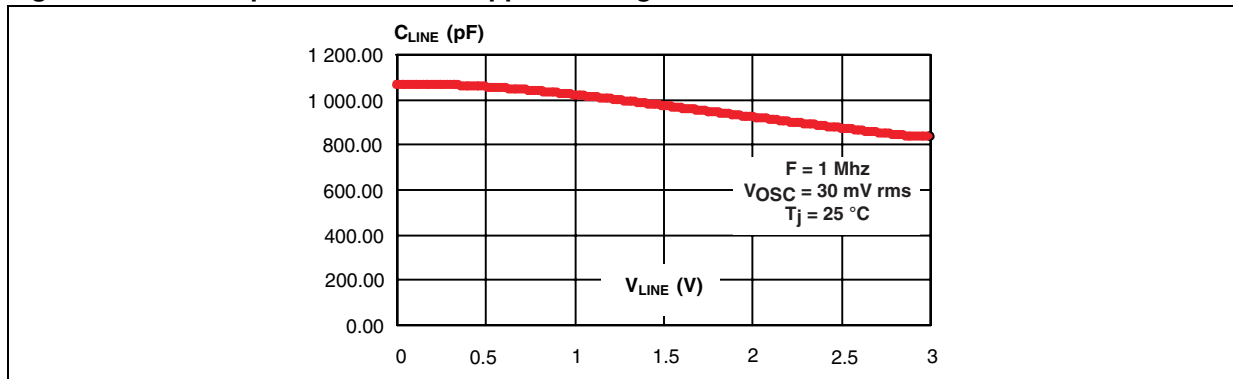
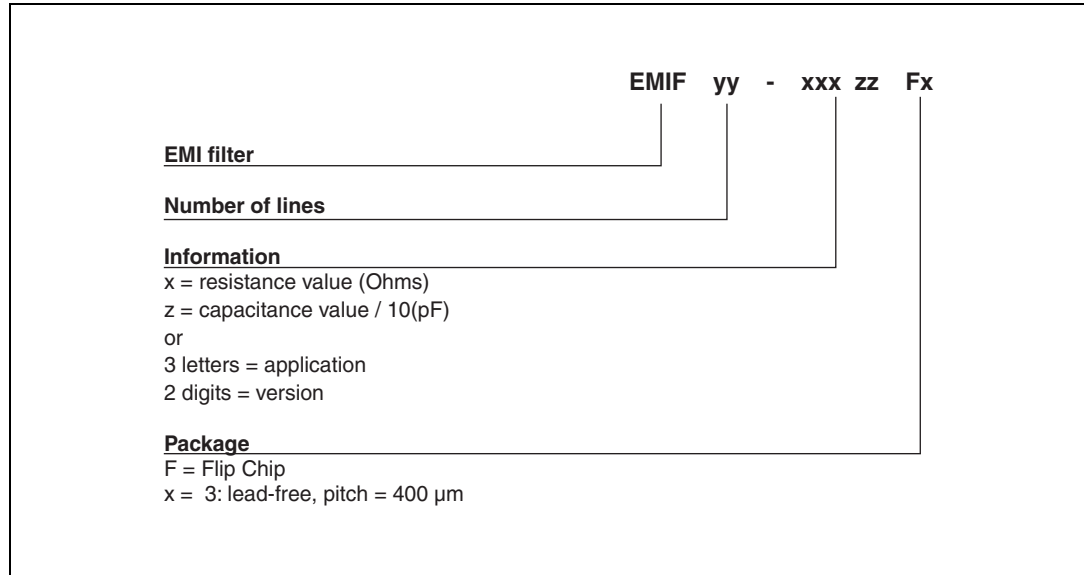

Figure 10. Line capacitance versus applied voltage



2 Ordering information scheme

Figure 11. Ordering information scheme



3 Package information

In order to meet environmental requirements, ST offers these devices in different grades of ECOPACK[®] packages, depending on their level of environmental compliance. ECOPACK[®] specifications, grade definitions and product status are available at: www.st.com. ECOPACK[®] is an ST trademark.

Figure 12. Flip Chip package dimensions

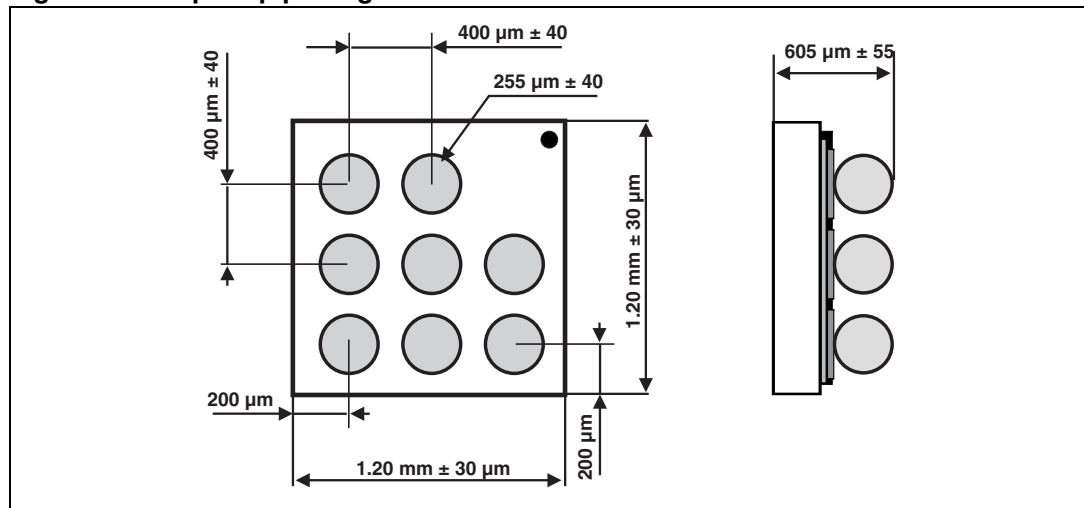

Figure 13. Footprint recommendations **Figure 14. Marking**

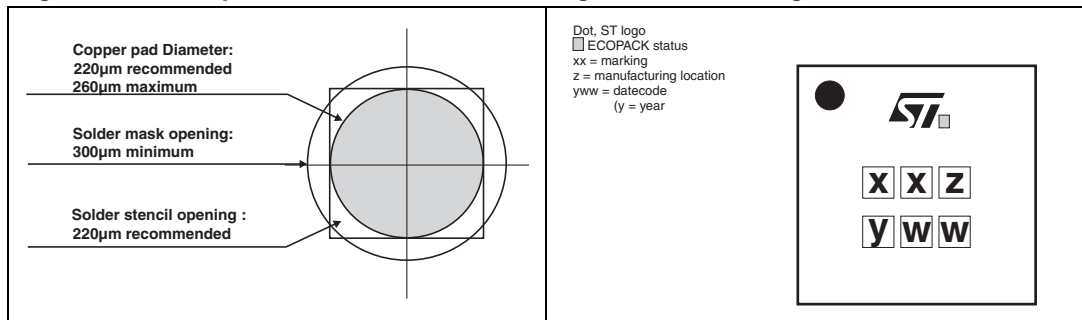
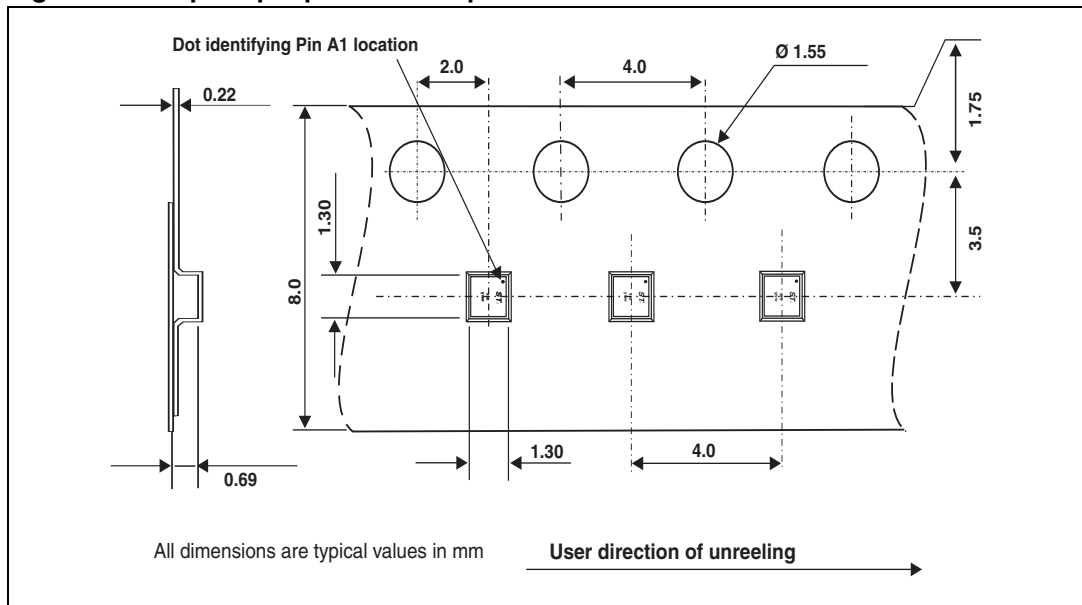

Figure 15. Flip Chip tape and reel specification



4 Ordering information

Table 3. Ordering information

Order code	Marking	Package	Weight	Base qty	Delivery mode
EMIF02-MIC06F3	JB	Flip Chip	1.8 mg	5000	Tape and reel 7"

Note: More information is available in the application notes
 AN2348: "Flip Chip: Package description and recommendations for use"
 AN1751: "EMI Filters: Recommendations and measurements"

5 Revision history

Table 4. Document revision history

Date	Revision	Changes
21-Nov-2008	1	Initial release
05-Mar-2009	2	Updated <i>Figure 4</i> and <i>Figure 12</i> .
07-Apr-2010	3	Updated tolerance <i>Figure 12</i> .
23-Sep-2011	4	Added <i>ECl pin connection on page 2</i> .

Please Read Carefully:

Information in this document is provided solely in connection with ST products. STMicroelectronics NV and its subsidiaries ("ST") reserve the right to make changes, corrections, modifications or improvements, to this document, and the products and services described herein at any time, without notice.

All ST products are sold pursuant to ST's terms and conditions of sale.

Purchasers are solely responsible for the choice, selection and use of the ST products and services described herein, and ST assumes no liability whatsoever relating to the choice, selection or use of the ST products and services described herein.

No license, express or implied, by estoppel or otherwise, to any intellectual property rights is granted under this document. If any part of this document refers to any third party products or services it shall not be deemed a license grant by ST for the use of such third party products or services, or any intellectual property contained therein or considered as a warranty covering the use in any manner whatsoever of such third party products or services or any intellectual property contained therein.

UNLESS OTHERWISE SET FORTH IN ST'S TERMS AND CONDITIONS OF SALE ST DISCLAIMS ANY EXPRESS OR IMPLIED WARRANTY WITH RESPECT TO THE USE AND/OR SALE OF ST PRODUCTS INCLUDING WITHOUT LIMITATION IMPLIED WARRANTIES OF MERCHANTABILITY, FITNESS FOR A PARTICULAR PURPOSE (AND THEIR EQUIVALENTS UNDER THE LAWS OF ANY JURISDICTION), OR INFRINGEMENT OF ANY PATENT, COPYRIGHT OR OTHER INTELLECTUAL PROPERTY RIGHT.

UNLESS EXPRESSLY APPROVED IN WRITING BY TWO AUTHORIZED ST REPRESENTATIVES, ST PRODUCTS ARE NOT RECOMMENDED, AUTHORIZED OR WARRANTED FOR USE IN MILITARY, AIR CRAFT, SPACE, LIFE SAVING, OR LIFE SUSTAINING APPLICATIONS, NOR IN PRODUCTS OR SYSTEMS WHERE FAILURE OR MALFUNCTION MAY RESULT IN PERSONAL INJURY, DEATH, OR SEVERE PROPERTY OR ENVIRONMENTAL DAMAGE. ST PRODUCTS WHICH ARE NOT SPECIFIED AS "AUTOMOTIVE GRADE" MAY ONLY BE USED IN AUTOMOTIVE APPLICATIONS AT USER'S OWN RISK.

Resale of ST products with provisions different from the statements and/or technical features set forth in this document shall immediately void any warranty granted by ST for the ST product or service described herein and shall not create or extend in any manner whatsoever, any liability of ST.

ST and the ST logo are trademarks or registered trademarks of ST in various countries.

Information in this document supersedes and replaces all information previously supplied.

The ST logo is a registered trademark of STMicroelectronics. All other names are the property of their respective owners.

© 2011 STMicroelectronics - All rights reserved

STMicroelectronics group of companies

Australia - Belgium - Brazil - Canada - China - Czech Republic - Finland - France - Germany - Hong Kong - India - Israel - Italy - Japan - Malaysia - Malta - Morocco - Philippines - Singapore - Spain - Sweden - Switzerland - United Kingdom - United States of America

www.st.com