

Legacy NMA2009-A1D 500 Hz to 500 MHz



Specifications

RF Frequency	500 Hz to 500 MHz
Noise Output	60 dB Min ENR
Noise Spectral Density (N_o)	-114 dBm/Hz Min
Flatness	4 dB P-P Max
Peak Factor	5:1
Bias Voltage	15 V
Supply Current	25 mA Max
Impedance	50 ohms

Package and Connectivity

Construction	DIP 14 PIN
--------------	------------

Environmental

Operating Temperature	-55 to 95 °C
Storage Temperature	-65 to 125 °C

Notes

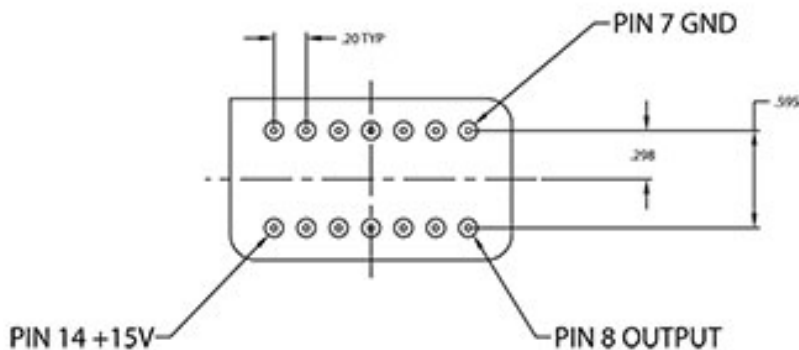
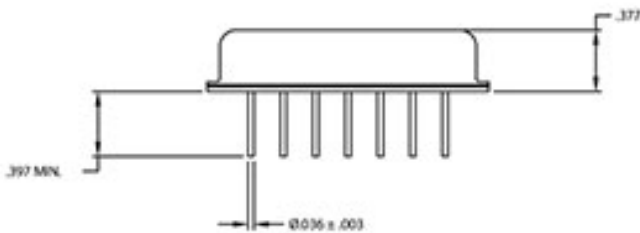
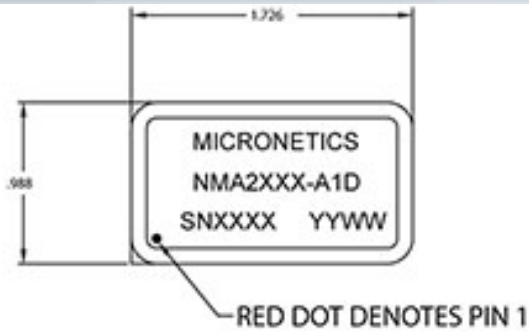

Specifications subject to change without notice

Micronetics, Inc. | Hudson, NH | Tel: 1-603-883-2900 | www.Micronetics.com

MICRONETICS

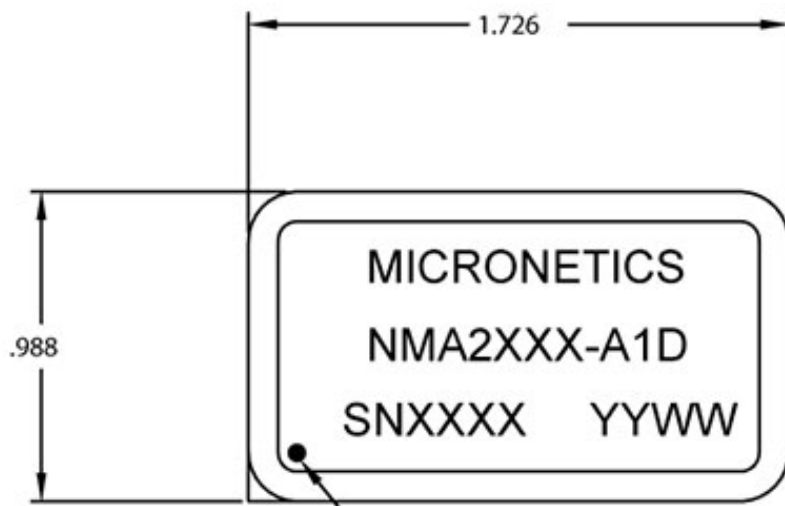

RED DOT DENOTES PIN 1

