

2SC5099

Silicon NPN Triple Diffused Planar Transistor (Complement to type 2SA1907)

Application : Audio and General Purpose

Absolute maximum ratings (Ta=25°C)

Symbol	2SC5099	Unit
V _{CB0}	120	V
V _{CE0}	80	V
V _{EB0}	6	V
I _c	6	A
I _B	3	A
P _c	60(T _c =25°C)	W
T _j	150	°C
T _{stg}	-55 to +150	°C

Electrical Characteristics (Ta=25°C)

Symbol	Conditions	2SC5099	Unit
I _{CB0}	V _{CB} =120V	10max	μA
I _{EB0}	V _{EB} =6V	10max	μA
V _{(BR)CEO}	I _c =50mA	80min	V
h _{FE}	V _{CE} =4V, I _c =2A	50min*	
V _{CE(sat)}	I _c =2A, I _B =0.2A	0.5max	V
f _T	V _{CE} =12V, I _E =-0.5A	20typ	MHz
COB	V _{CB} =10V, f=1MHz	110typ	pF

*h_{FE} Rank \bar{O} (50 to 100), P(70 to 140), Y(90 to 180)

External Dimensions FM100(TO3PF)

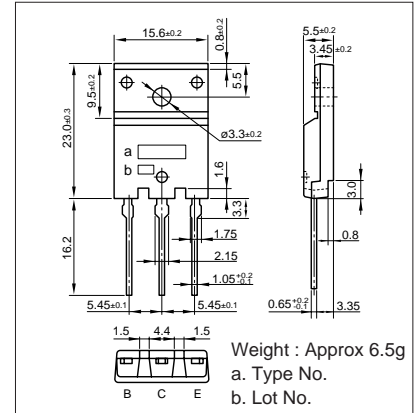

Typical Switching Characteristics (Common Emitter)

V _{CC} (V)	R _L (Ω)	I _c (A)	V _{BB1} (V)	V _{BB2} (V)	I _{B1} (A)	I _{B2} (A)	t _{on} (μs)	t _{stg} (μs)	t _f (μs)
30	10	3	10	-5	0.3	-0.3	0.16typ	2.60typ	0.34typ

I_c-V_{CE} Characteristics (Typical)

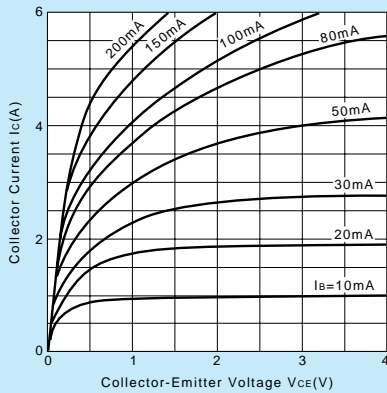

V_{CE(sat)}-I_B Characteristics (Typical)

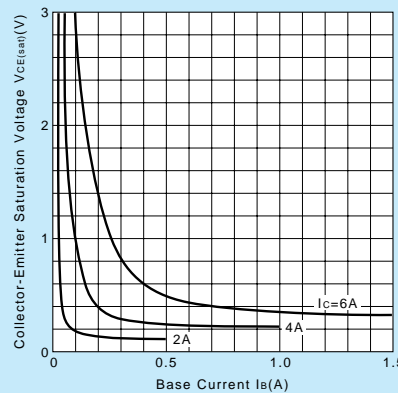

I_c-V_{BE} Temperature Characteristics (Typical)

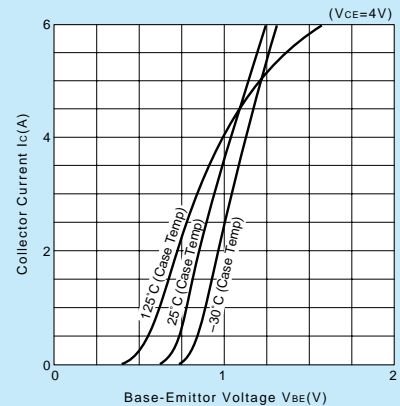

h_{FE}-I_c Characteristics (Typical)

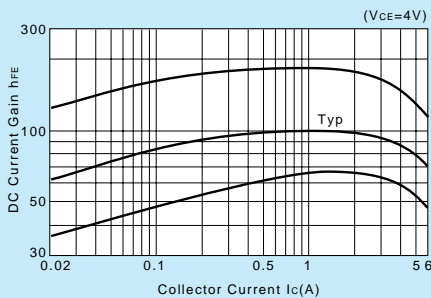

h_{FE}-I_c Temperature Characteristics (Typical)

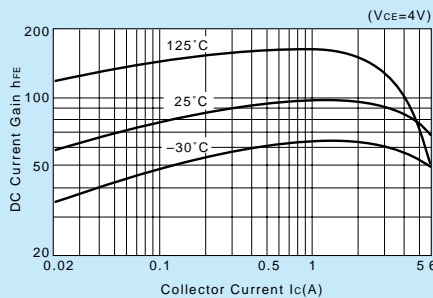

θ_{j-a}-t Characteristics

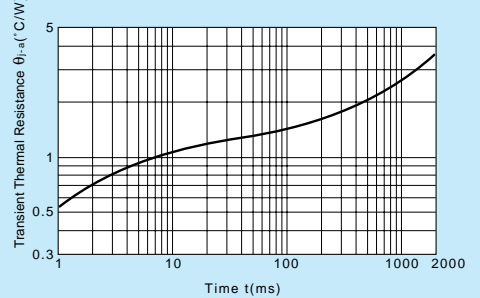

f_T-I_E Characteristics (Typical)

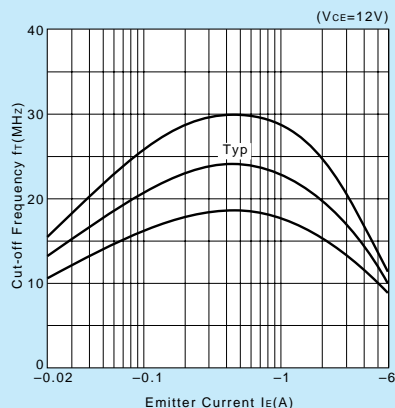

Safe Operating Area (Single Pulse)

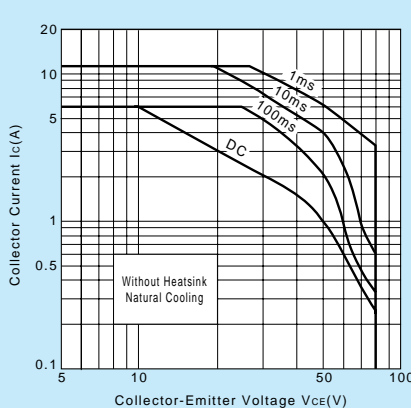

P_c-T_a Derating

