

**Tandem 600V HYPERFAST BOOST DIODE**
**MAJOR PRODUCTS CHARACTERISTICS**

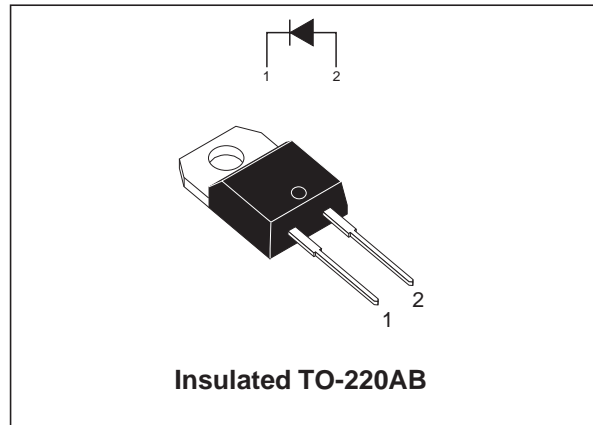
<b>I<sub>F(AV)</sub></b>	<b>8 A</b>
<b>V<sub>RRM</sub></b>	<b>600 V</b>
<b>T<sub>j (max)</sub></b>	<b>150 °C</b>
<b>V<sub>F (max)</sub></b>	<b>2.4 V</b>
<b>I<sub>RM (typ.)</sub></b>	<b>4 A</b>
<b>t<sub>rr (typ.)</sub></b>	<b>13 ns</b>

**FEATURES AND BENEFITS**

- ESPECIALLY SUITED AS BOOST DIODE IN CONTINUOUS MODE POWER FACTOR CORRECTORS AND HARD SWITCHING CONDITIONS
- DESIGNED FOR HIGH DI/DT OPERATION. HYPERFAST RECOVERY CURRENT TO COMPETE WITH SIC DEVICES. ALLOWS DOWNSIZING OF MOSFET AND HEATSINKS
- INTERNAL CERAMIC INSULATED DEVICES WITH EQUAL THERMAL CONDITIONS FOR BOTH 300V DIODES
- INSULATION (2500V<sub>RMS</sub>) ALLOWS PLACEMENT ON SAME HEATSINK AS MOSFET AND FLEXIBLE HEATSINKING ON COMMON OR SEPARATE HEATSINK
- STATIC AND DYNAMIC EQUILIBRIUM OF INTERNAL DIODES ARE WARRANTED BY DESIGN
- PACKAGE CAPACITANCE: C=7pF

**ABSOLUTE RATINGS** (limiting values)

Symbol	Parameter		Value	Unit
V <sub>RRM</sub>	Repetitive peak reverse voltage		600	V
I <sub>F(RMS)</sub>	RMS forward current		14	A
I <sub>FSM</sub>	Surge non repetitive forward current	tp = 10 ms sinusoidal	80	A
I <sub>peak</sub>	Peak current waveform	δ = 0.15 Tc = 130°C	17	A
T <sub>stg</sub>	Storage temperature range		-65 +150	°C
T <sub>j</sub>	Maximum operating junction temperature		+ 150	°C


**DESCRIPTION**

The TURBOSWITCH "H" is an ultra high performance diode composed of two 300V dice in series. TURBOSWITCH "H" family drastically cuts losses in the associated MOSFET when run at high di<sub>F</sub>/dt.

## STTH806DTI

### THERMAL AND POWER DATA

Symbol	Parameter	Test conditions	Value	Unit
$R_{th(j-c)}$	Junction to case thermal resistance		2.6	°C/W

### STATIC ELECTRICAL CHARACTERISTICS

Symbol	Parameter	Tests Conditions	Min.	Typ.	Max.	Unit
$I_R^*$	Reverse leakage current	$V_R = V_{RRM}$	$T_j = 25^\circ\text{C}$		10	$\mu\text{A}$
			$T_j = 125^\circ\text{C}$		15	
$V_F^{**}$	Forward voltage drop	$I_F = 8\text{ A}$	$T_j = 25^\circ\text{C}$		3.6	V
			$T_j = 150^\circ\text{C}$		1.95	

Pulse test : \*  $t_p = 100\text{ ms}$ ,  $\delta < 2\%$

\*\*  $t_p = 380\text{ }\mu\text{s}$ ,  $\delta < 2\%$

To evaluate the maximum conduction losses use the following equation :

$$P = 1.7 \times I_{F(AV)} + 0.087 I_{F(RMS)}^2$$

### RECOVERY CHARACTERISTICS

Symbol	Parameter	Tests Conditions	Min.	Typ.	Max.	Unit	
$t_{rr}$	Reverse recovery time	$I_F = 0.5\text{ A}$ $I_{rr} = 0.25\text{ A}$ $I_R = 1\text{ A}$	$T_j = 25^\circ\text{C}$		13	ns	
		$I_F = 1\text{ A}$ $dI_F/dt = -50\text{ A}/\mu\text{s}$ $V_R = 30\text{ V}$					30
$I_{RM}$	Reverse recovery current	$V_R = 400\text{ V}$ $I_F = 8\text{ A}$ $dI_F/dt = -200\text{ A}/\mu\text{s}$	$T_j = 125^\circ\text{C}$		4	5.5	A
S	Reverse recovery softness factor				0.4		-
$Q_{rr}$	Reverse recovery charges				50		nC

### TURN-ON SWITCHING CHARACTERISTICS

Symbol	Parameter	Tests Conditions	Min.	Typ.	Max.	Unit
$t_{fr}$	Forward recovery time	$I_F = 8\text{ A}$ $dI_F/dt = 100\text{ A}/\mu\text{s}$ , $V_{FR} = 1.1 \times V_{Fmax}$	$T_j = 25^\circ\text{C}$		200	ns
$V_{FP}$	Forward recovery voltage	$I_F = 8\text{ A}$ $dI_F/dt = 100\text{ A}/\mu\text{s}$	$T_j = 25^\circ\text{C}$		7	V

Fig. 1: Conduction losses versus average current.

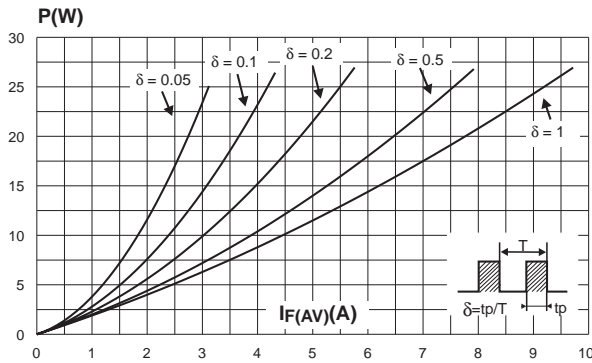


Fig. 2: Forward voltage drop versus forward current.

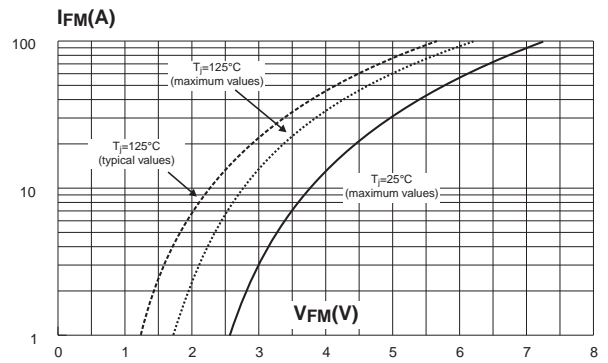


Fig. 3: Relative variation of thermal impedance junction to case versus pulse duration.

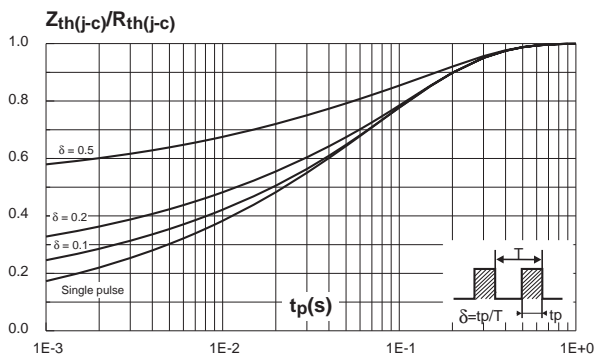


Fig. 4: Peak reverse recovery current versus dIF/dt (typical values).

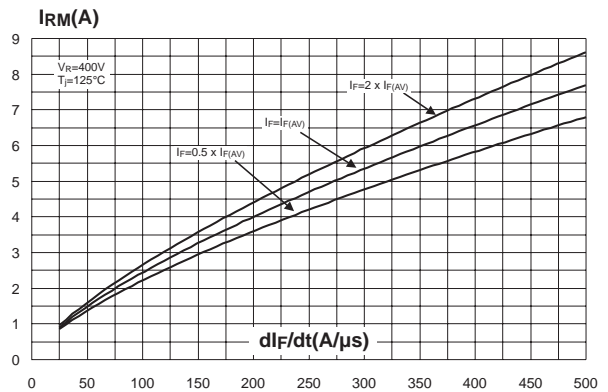


Fig. 5: Reverse recovery time versus dIF/dt (typical values).

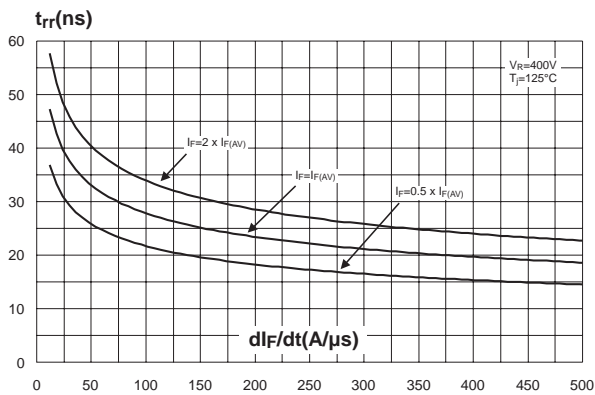
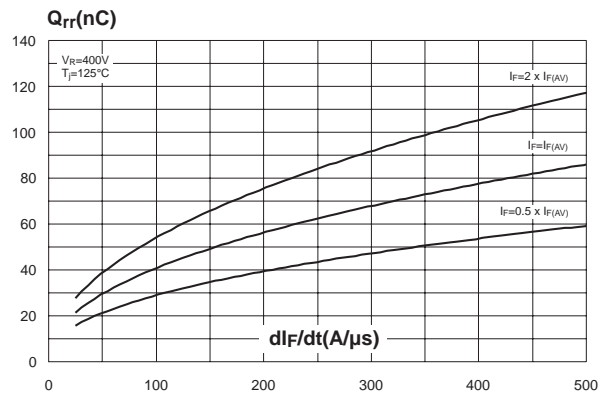
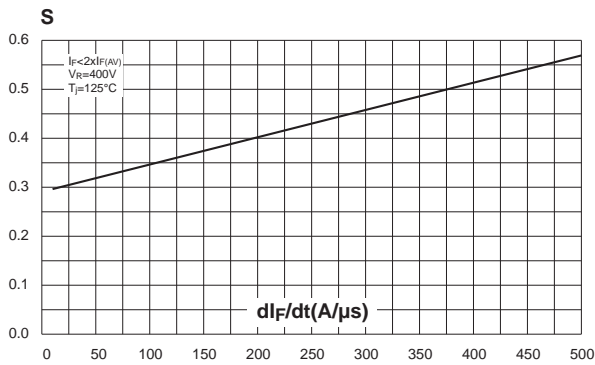


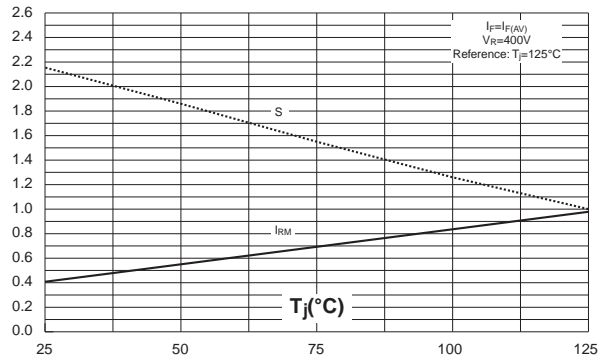
Fig. 6: Reverse charges versus dIF/dt (typical values).



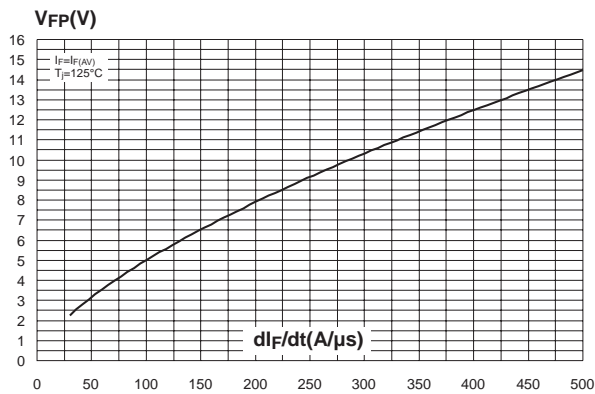
**Fig. 7:** Softness factor versus  $di_F/dt$  (typical values).



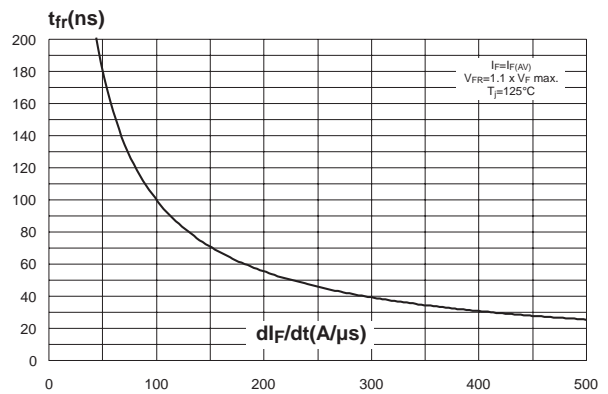
**Fig. 8:** Relative variation of dynamic parameters versus junction temperature (reference:  $T_J = 125^\circ C$ ).

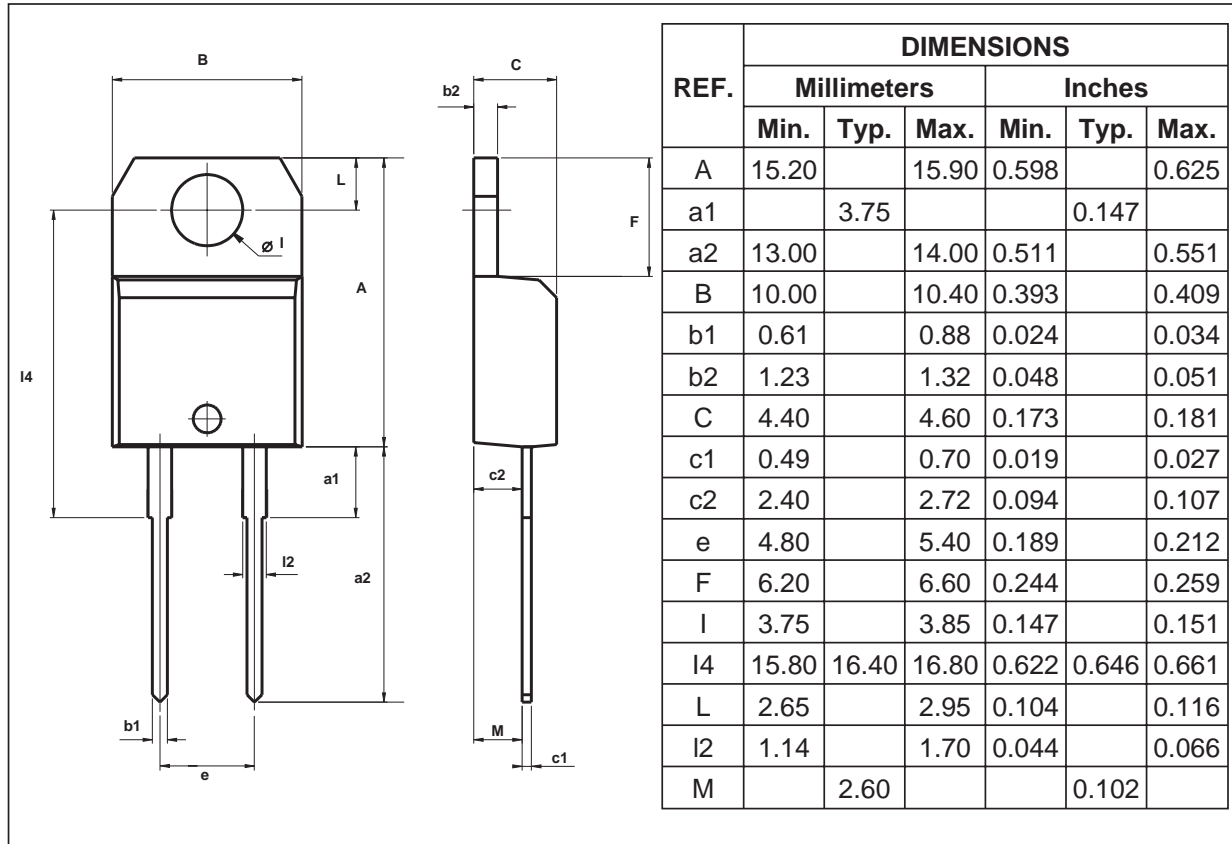


**Fig. 9:** Transient peak forward voltage versus  $di_F/dt$  (typical values).



**Fig. 10:** Forward recovery time versus  $di_F/dt$  (typical values).



**PACKAGE MECHANICAL DATA**  
**TO-220AC**


Ordering code	Marking	Package	Weight	Base qty	Delivery mode
STTH806DTI	STTH806DTI	TO-220AC	2.3 g.	50	Tube

- Cooling method: C
- Recommended torque value: 0.8 N.m.
- Maximum torque value: 1 N.m.
- Epoxy meets UL94,V0

Information furnished is believed to be accurate and reliable. However, STMicroelectronics assumes no responsibility for the consequences of use of such information nor for any infringement of patents or other rights of third parties which may result from its use. No license is granted by implication or otherwise under any patent or patent rights of STMicroelectronics. Specifications mentioned in this publication are subject to change without notice. This publication supersedes and replaces all information previously supplied. STMicroelectronics products are not authorized for use as critical components in life support devices or systems without express written approval of STMicroelectronics.

The ST logo is a registered trademark of STMicroelectronics.

All other names are the property of their respective owners.

© 2003 STMicroelectronics - All rights reserved.

STMicroelectronics GROUP OF COMPANIES

Australia - Belgium - Brazil - Canada - China - Czech Republic - Finland - France - Germany -  
 Hong Kong - India - Israel - Italy - Japan - Malaysia - Malta - Morocco - Singapore - Spain -  
 Sweden - Switzerland - United Kingdom - United States

[www.st.com](http://www.st.com)

