

Video driver hybrid amplifiers

CR4424; CR4425; CR4427

FEATURES

- Typical 10 to 90% transition times with $C_L = 8.5$ pF:
 - 1.6 ns at 35 V(p-p) swing
 - 1.7 ns at 40 V(p-p) swing
 - 1.9 ns at 50 V(p-p) swing
- Low power consumption
- Minimum bandwidth 200 MHz
- Very fast slew rate; 25 V/ μ s
- Excellent grey-scale linearity
- Unconditional stability
- Gold metallization ensures excellent reliability.

DESCRIPTION

Hybrid amplifier modules mounted in SOT115 (CR4424; CR4425) and SOT348 (CR4427) packages and designed for application in cathode-ray tube (CRT) drivers in high-resolution colour and monochrome monitors.

PINNING - SOT115

PIN	DESCRIPTION
1	input
2	ground
3	ground
5	supply voltage (V_{CC})
7	ground
8	ground
9	output

PINNING - SOT348

PIN	DESCRIPTION
1	input
2	ground
3	supply voltage (V_{CC})
4	ground
5	output

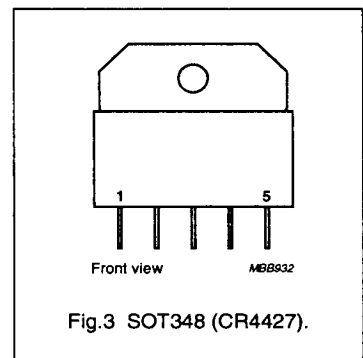
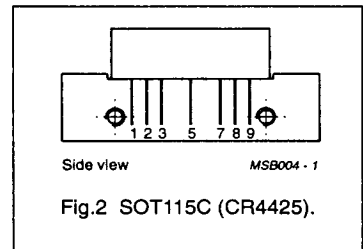
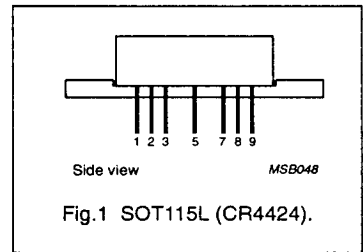

LIMITING VALUES

In accordance with the Absolute Maximum System (IEC 134).

SYMBOL	PARAMETER	MIN.	MAX.	UNIT
V_{CC}	DC supply voltage	--	90	V
T_{mb}	mounting base operating temperature (note 1)	-20	100	$^{\circ}$ C
T_{stg}	storage temperature	-40	125	$^{\circ}$ C

Note

1. To ensure proper thermal contact, a layer of heatsink compound should be applied between the module and heatsink.

Video driver hybrid amplifiers

CR4424; CR4425; CR4427

ELECTRICAL CHARACTERISTICS

$V_{CC} = 80\text{ V}$; $T_c = 25\text{ }^\circ\text{C}$; $C_L = 8.5\text{ pF}$; $R_1 = 287\text{ }\Omega$; $C_1 = 60\text{ pF}$; 40 V(p-p) output swing with 40 V DC offset, unless otherwise specified.

SYMBOL	PARAMETER	CONDITIONS	MIN.	TYP.	MAX.	UNIT
I_{CC}	supply current	input and output open	39	45	51	mA
V_I	DC input level	input and output open	1.3	1.5	1.8	V
V_O	DC output level	input and output open	36	40	44	V
P_{tot}	total power dissipation	50 MHz square wave	–	–	8	W
t_r	transient response rise time	10 to 90% (note 1)	–	1.7	2.0	ns
t_f	transient response fall time	10 to 90% (note 1)	–	1.7	2.0	ns
B	bandwidth	between –3 dB points	200	215	–	MHz
V_{TILT}	low frequency tilt voltage	1 kHz square wave	–	1.3	1.5	V
ΔV_I	input voltage swing (rise and fall time)	varied by C1 (see Fig.8)	–	–	10	%
	linearity	$V_O = 5\text{ to }75\text{ V}$	–	2	5	%
ΔG	insertion gain	50 Ω source (note 2)	160	180	200	
ΔG_V	voltage gain	50 Ω source (note 3)	11.2	12.4	13.2	

Notes

1. Input signal is a nominal 100 kHz square wave of 3.25 V(p-p), with 1.5 V DC offset (50 Ω source).
2. Measured V_O/V_I port 1 (see voltage ratio figure).
3. Measured in CRT amplifier test circuit: $V_O/V_{RF\text{ input}}$.

Video driver hybrid amplifiers

CR4424; CR4425; CR4427

In Figs 4 to 7, $V_{CC} = 80 \text{ V}$; $T_c = 25 \text{ }^\circ\text{C}$; $C_L = 8.5 \text{ pF}$; $R_1 = 287 \text{ } \Omega$; $C_1 = 60 \text{ pF}$; 40 V(p-p) output swing with 40 V DC offset, unless otherwise specified.

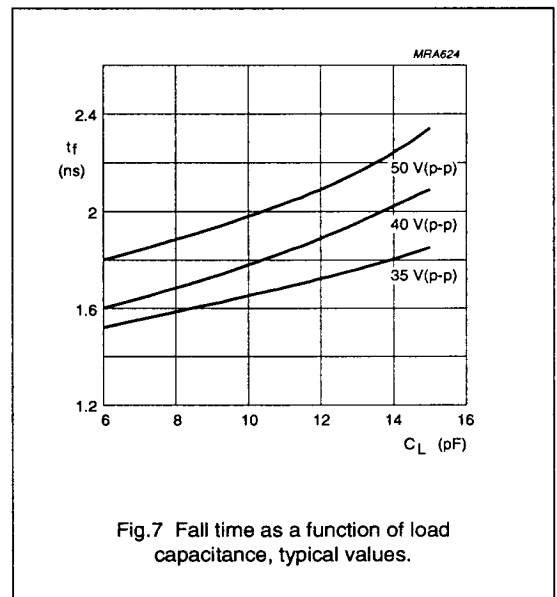
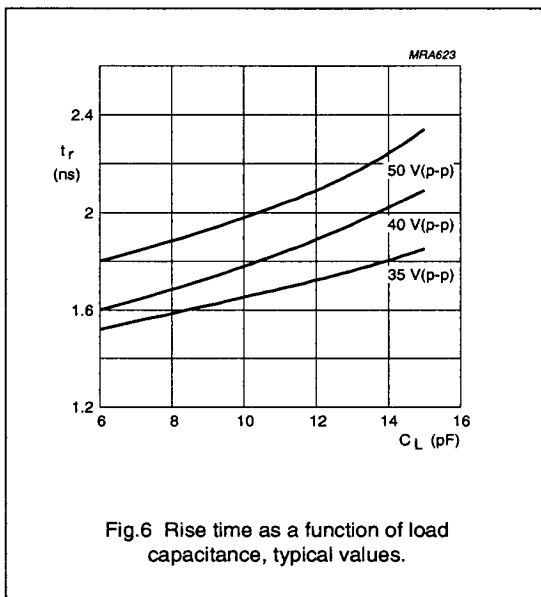
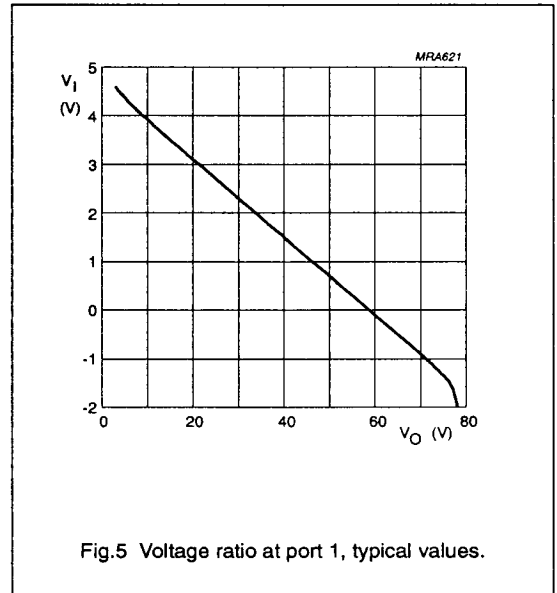
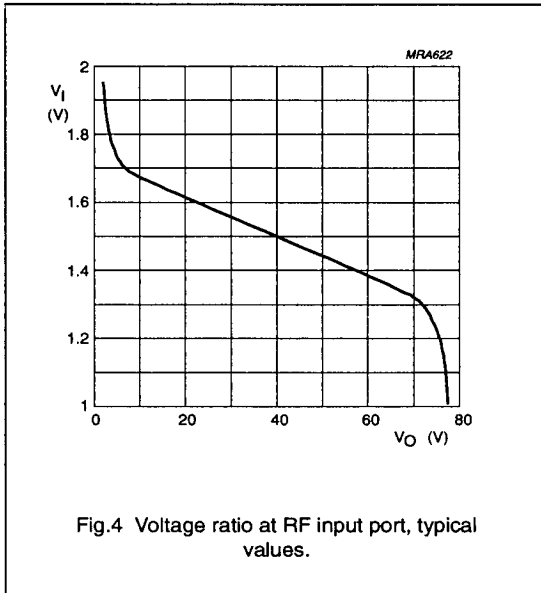

Video driver hybrid amplifiers

CR4424; CR4425; CR4427

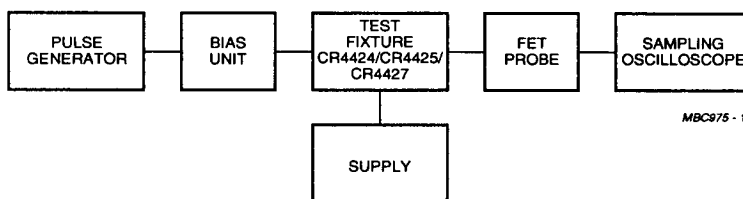
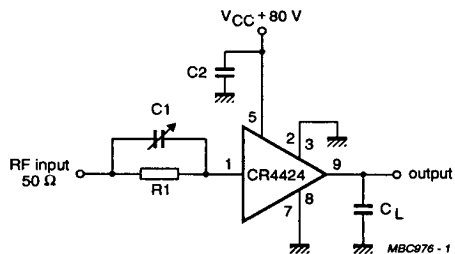

Fig.8 CRT amplifier test circuit and block diagram.

List of components (see test circuit)

DESIGNATION	DESCRIPTION	VALUE
C1	capacitor	10 to 120 pF (typically 60 pF)
C2	chip capacitor, plus electrolytic capacitor	10 nF, plus 4.7 μ F/160 V
R1	resistor	typically 287 Ω

Equipment used in test circuit

Pulse generator	Pico Second, model 2600B, rise time 350 ps
Bias unit	Pico Second, model 5555
Power supply	80 V
FET probe	Philips, model PM8943, attenuation 100:1
Sampling oscilloscope	Tektronix, model 11803, sampling head SD24