

**HEXFET® Power MOSFET**

- Ultra Low Gate Charge
- Reduced Gate Drive Requirement
- Enhanced 30V  $V_{GS}$  Rating
- Reduced  $C_{iss}$ ,  $C_{oss}$ ,  $C_{rss}$
- Extremely High Frequency Operation
- Repetitive Avalanche Rated

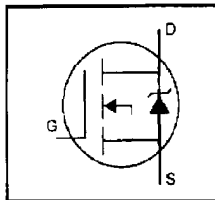

$V_{DSS} = 500V$

$R_{DS(on)} = 0.85\Omega$

$I_D = 8.0A$

**Description**

This new series of Low Charge HEXFETs achieve significantly lower gate charge over conventional MOSFETs. Utilizing the new LCDMOS technology, the device improvements are achieved without added product cost, allowing for reduced gate drive requirements and total system savings. In addition, reduced switching losses and improved efficiency are achievable in a variety of high frequency applications. Frequencies of a few MHz at high current are possible using the new Low Charge MOSFETs.

These device improvements combined with the proven ruggedness and reliability that are characteristic of HEXFETs offer the designer a new standard in power transistors for switching applications.

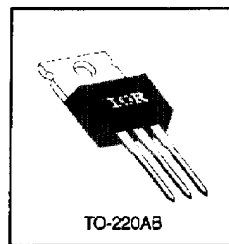

**Absolute Maximum Ratings**

	Parameter	Max.	Units
$I_D @ T_C = 25^\circ C$	Continuous Drain Current, $V_{GS} @ 10V$	8.0	A
$I_D @ T_C = 100^\circ C$	Continuous Drain Current, $V_{GS} @ 10V$	5.1	
$I_{DM}$	Pulsed Drain Current $\text{\textcircled{1}}$	28	
$P_D @ T_C = 25^\circ C$	Power Dissipation	125	W
	Linear Derating Factor	1.0	W/°C
$V_{GS}$	Gate-to-Source Voltage	-30	V
$E_{AS}$	Single Pulse Avalanche Energy $\text{\textcircled{2}}$	510	mJ
$I_{AR}$	Avalanche Current $\text{\textcircled{3}}$	8.0	A
$E_{AR}$	Repetitive Avalanche Energy $\text{\textcircled{3}}$	13	mJ
$dv/dt$	Peak Diode Recovery $dv/dt$ $\text{\textcircled{3}}$	3.5	V/ns
$T_J$	Operating Junction and	-55 to +150	°C
$T_{STG}$	Storage Temperature Range		
	Soldering Temperature, for 10 seconds	300 (1.6mm from case)	
	Mounting Torque, 6-32 or M3 screw	10 lbf-in (1.1 N-m)	

**Thermal Resistance**

	Parameter	Min.	Typ.	Max.	Units
$R_{\theta JC}$	Junction-to-Case	—	—	1.0	°C/W
$R_{\theta CS}$	Case-to-Sink, Flat, Greased Surface	—	0.50	—	
$R_{\theta JA}$	Junction-to-Ambient	—	—	62	

Electrical Characteristics @  $T_J = 25^\circ\text{C}$  (unless otherwise specified)

Parameter	Min.	Typ.	Max.	Units	Test Conditions
$V_{BR(DSS)}$	500	—	—	V	$V_{GS}=0\text{V}$ , $I_D=250\mu\text{A}$
$\Delta V_{BR(DSS)}/\Delta T_J$	—	0.63	—	$^\circ\text{C}$	Reference to $25^\circ\text{C}$ , $I_D=1\text{mA}$
$R_{DS(on)}$	—	0.85	—	$\Omega$	$V_{GS}=10\text{V}$ , $I_D=4.8\text{A}$ ①
$V_{GS(th)}$	2.0	—	4.0	V	$V_{DS}=V_{GS}$ , $I_D=250\mu\text{A}$
$g_{fs}$	4.0	—	—	S	$V_{DS}=50\text{V}$ , $I_D=4.8\text{A}$ ②
$I_{DSS}$	—	—	25	$\mu\text{A}$	$V_{DS}=500\text{V}$ , $V_{GS}=0\text{V}$
	—	—	250	$\mu\text{A}$	$V_{DS}=400\text{V}$ , $V_{GS}=0\text{V}$ , $T_J=125^\circ\text{C}$
$I_{GSS}$	—	—	100	nA	$V_{GS}=20\text{V}$
	—	—	100	nA	$V_{GS}=-20\text{V}$
$Q_g$	—	—	39	nC	$I_D=8.0\text{A}$
$Q_{gs}$	—	—	10	nC	$V_{DS}=400\text{V}$
$Q_{gd}$	—	—	19	nC	$V_{GS}=10\text{V}$ See Fig. 5 and 13 ③
$t_{(on)}$	—	12	—	ns	$V_{DD}=250\text{V}$
$t_r$	—	25	—	ns	$I_D=8.0\text{A}$
$t_{(off)}$	—	27	—	ns	$R_G=9.1\Omega$
$t_f$	—	19	—	ns	$R_D=30\Omega$ See Figure 10 ④
$L_D$	—	4.5	—	nH	Between lead, 6 mm (0.25in.) from package and center of die contact
$L_S$	—	7.5	—	nH	
$C_{iss}$	—	1100	—	pF	$V_{DS}=0\text{V}$
$C_{oss}$	—	170	—	pF	$V_{DS}=25\text{V}$
$C_{rst}$	—	18	—	pF	$f=1.0\text{MHz}$ See Figure 5

## Source-Drain Ratings and Characteristics

Parameter	Min.	Typ.	Max.	Units	Test Conditions
$I_S$	—	—	8.0	A	MOSFET symbol showing the integral reverse p-n junction diode.
$I_{SM}$	—	—	28	A	
$V_{SD}$	—	—	2.0	V	$T_J=25^\circ\text{C}$ , $I_S=8.0\text{A}$ , $V_{GS}=0\text{V}$ ⑤
$t_{rr}$	—	490	740	ns	$T_J=25^\circ\text{C}$ , $I_F=8.0\text{A}$
$Q_{rr}$	—	3.0	4.5	$\mu\text{C}$	$dI/dt=100\text{A}/\mu\text{s}$ ⑥
$t_{on}$	Intrinsic turn-on time is negligible (turn-on is dominated by $L_S+L_D$ )				

## Notes:

- ① Repetitive rating; pulse width limited by max. junction temperature (See Figure 11)
- ②  $V_{DS}=50\text{V}$ , starting  $T_J=25^\circ\text{C}$ ,  $L=14\text{mH}$ ,  $R_G=25\Omega$ ,  $I_{AS}=8.0\text{A}$  (See Figure 12)
- ③  $I_{DS} \leq 8.0\text{A}$ ,  $dI/dt \leq 100\text{A}/\mu\text{s}$ ,  $V_{DD} \leq V_{BR(DSS)}$ ,  $T_J \leq 150^\circ\text{C}$
- ④ Pulse width  $\leq 300\mu\text{s}$ ; duty cycle  $\leq 2\%$ .

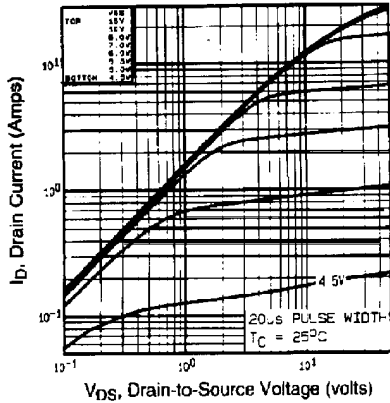

**Fig 1.** Typical Output Characteristics.  
 $T_C = 25^\circ\text{C}$

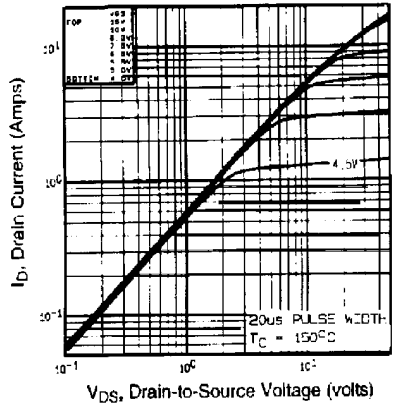

**Fig 2.** Typical Output Characteristics,  
 $T_C = 150^\circ\text{C}$

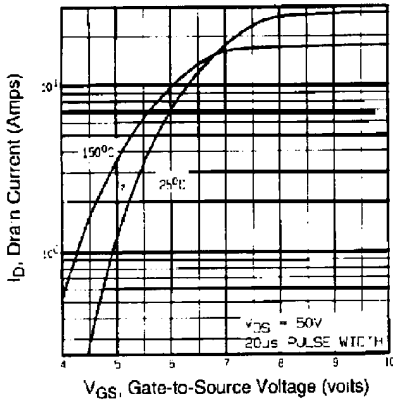

**Fig 3.** Typical Transfer Characteristics

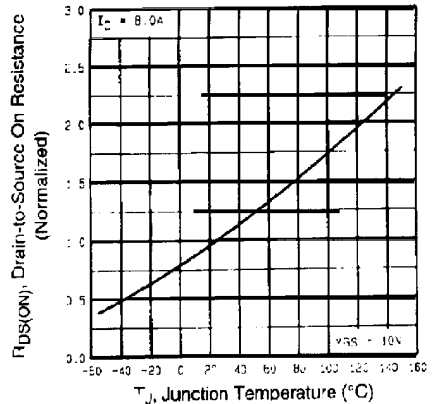

**Fig 4.** Normalized On-Resistance  
Vs. Temperature

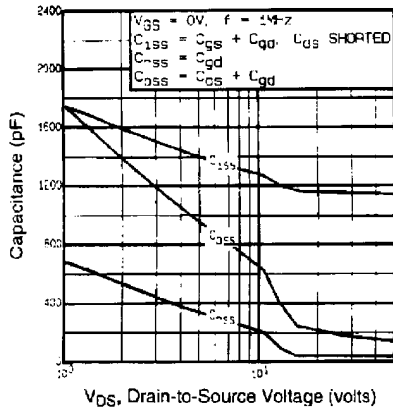

**Fig 5.** Typical Capacitance Vs. Drain-to-Source Voltage

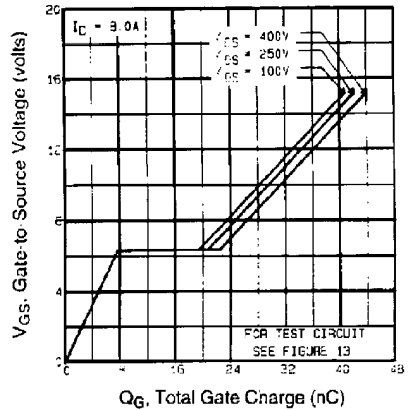

**Fig 6.** Typical Gate Charge Vs. Gate-to-Source Voltage

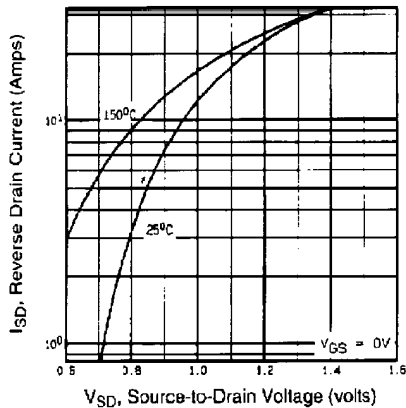

**Fig 7.** Typical Source-Drain Diode Forward Voltage

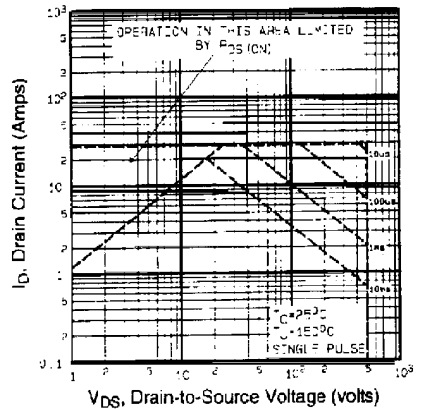

**Fig 8.** Maximum Safe Operating Area

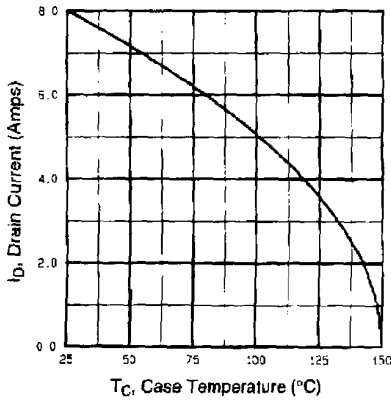

**Fig 9.** Maximum Drain Current Vs. Case Temperature

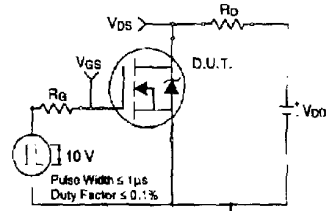

**Fig 10a.** Switching Time Test Circuit

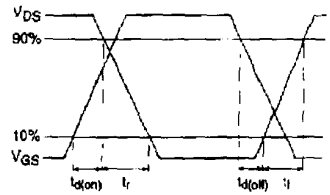

**Fig 10b.** Switching Time Waveforms

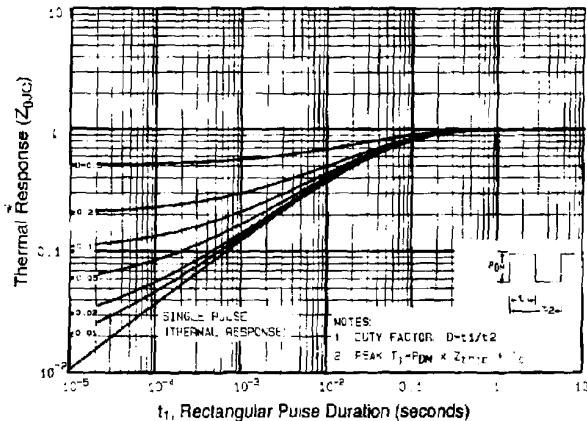

**Fig 11.** Maximum Effective Transient Thermal Impedance, Junction-to-Case

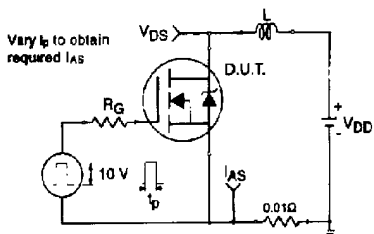

**Fig 12a.** Unclamped Inductive Test Circuit

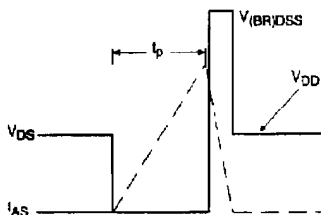

**Fig 12b.** Unclamped Inductive Waveforms

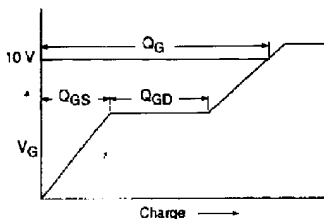

**Fig 13a.** Basic Gate Charge Waveform

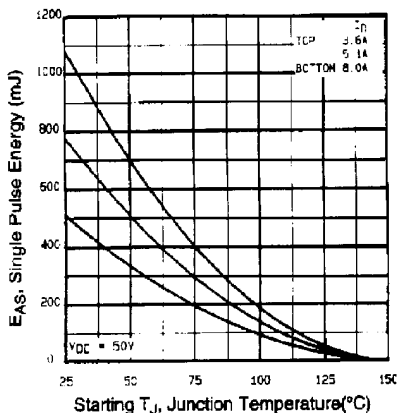

**Fig 13c.** Maximum Avalanche Energy Vs. Drain Current

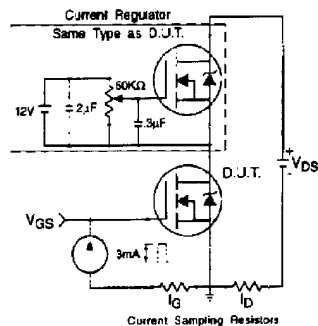

**Fig 13b.** Gate Charge Test Circuit

**Appendix A:** Figure 14, Peak Diode Recovery  $dv/dt$  Test Circuit

**Appendix B:** Package Outline Mechanical Drawing

**Appendix C:** Part Marking Information

# Appendix A

## Peak Diode Recovery dv/dt Test Circuit

Fig 14. For N-Channel HEXFETs

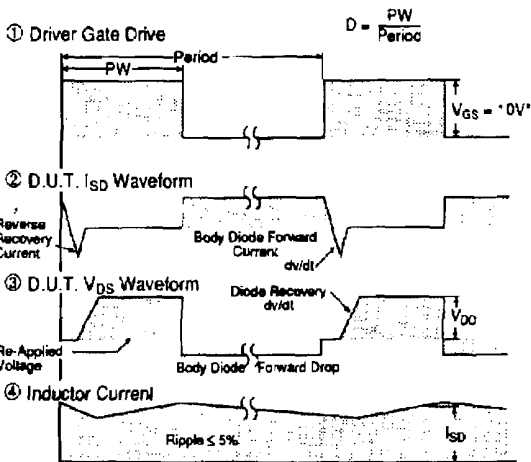
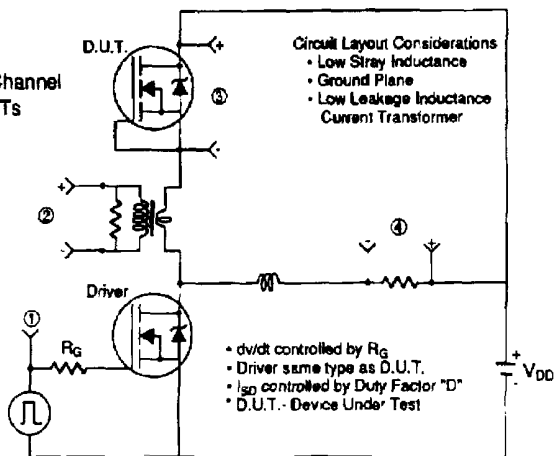

\*  $V_{GS} = 5V$  for Logic Level Devices

## Package Outline

## Appendix B

### TO-220AB Outline

Dimensions are shown in millimeters (inches)

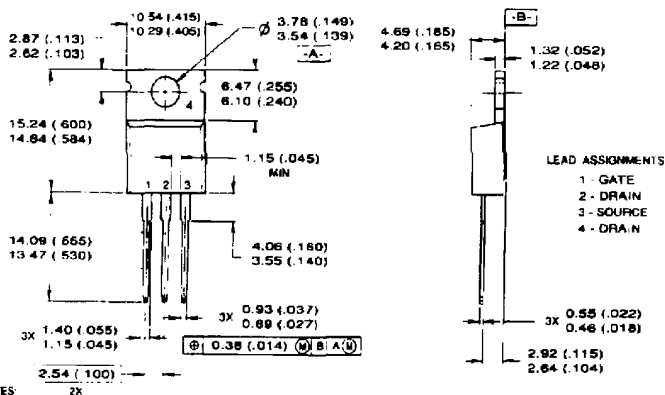

#### LEAD ASSIGNMENTS

- 1 - GATE
- 2 - DRAIN
- 3 - SOURCE
- 4 - DRAIN

#### NOTES

- 1 DIMENSIONING & TOLERANCING PER ANSI Y14.5M, 1982
- 2 CONTROLLING DIMENSION - INCH.
- 3 OUTLINE CONFORMS TO JEDEC OUTLINE TO 220-AB
- 4 HEATSINK & LEAD MEASUREMENTS DO NOT INCLUDE BURRS.

## Part Marking Information

## Appendix C

### TO-220AB

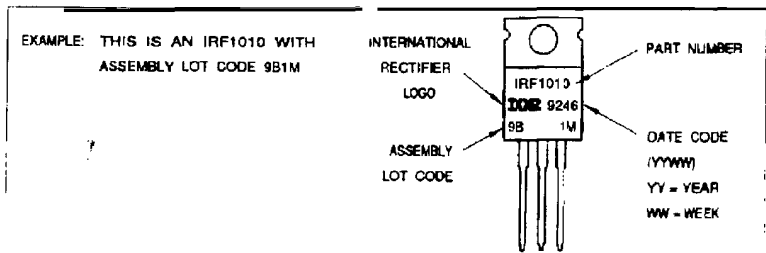

Printed on Signet recycled offset  
made from 50% recycled waste paper, including  
10% de-inked, post-consumer waste



**International**  
**IRF Rectifier**

WORLD HEADQUARTERS: 233 Kansas St., El Segundo, California 90246 Tel: (310) 322-3333 Fax: 4720403  
EUROPEAN HEADQUARTERS: Hurst Green, Oxford, Surrey RH9 9RH England. Tel: (0883) 713215 Telex: 96219

IN CANADA: 101 Bentley St., Markham, Ontario L3R 3L1, Tel: (416) 475-1807. IN GERMANY: Seelburgstrasse 157 D-6300 Bad Homburg, Tel: 0172-37008. IN ITALY: Via Ugiana 49 10071 Borgara, Ivrea, Tel: (011) 470 1484. IRFAR EAST: KAM Building, 30-4 Namweethere 3-Chrome, Inaheima-ku Tokyo 171 Japan. Tel: (03) 953 0641. IN SOUTHEAST ASIA: 190 Middle Road, HEX 10-01 Fortune Centre, Singapore 0718. Tel: (65) 336 3822.

Sales Offices, Agents and Distributors in Major Cities Throughout the World.