

Typical Applications

The HMC649LP6(E) is ideal for:

- EW Receivers
- Weather & Military Radar
- Satellite Communications
- Beamforming Modules
- Phase Cancellation

Features

- Low RMS Phase Error: 3°
- Low Insertion Loss: 8 dB
- High Linearity: +44 dBm
- Positive Control Logic
- 360° Coverage, LSB = 5.625°
- 28 Lead QFN Leadless SMT Package: 36mm²

Functional Diagram

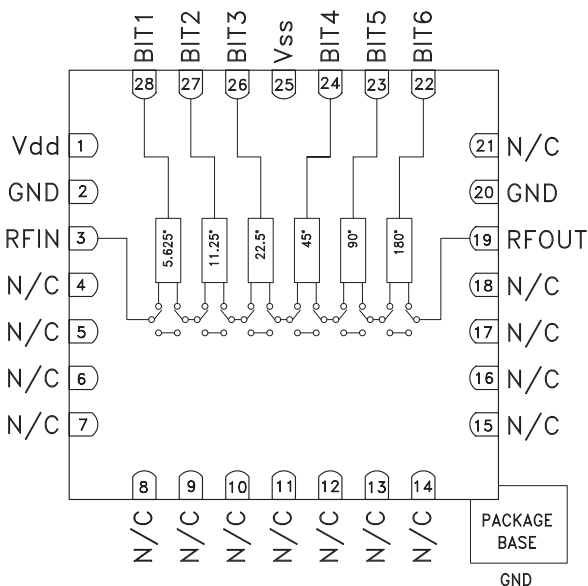

General Description

The HMC649LP6(E) is a 6-bit digital phase shifter which is rated from 3 - 6 GHz, providing 360 degrees of phase coverage, with a LSB of 5.625 degrees. The HMC649LP6(E) features very low RMS phase error of 3 degrees and extremely low insertion loss variation of ± 0.5 dB across all phase states. This high accuracy phase shifter is controlled with positive control logic of 0/+5V. The HMC649LP6(E) is housed in a compact 6x6 mm plastic leadless SMT package and is internally matched to 50 Ohms with no external components.

Electrical Specifications

$T_A = +25^\circ\text{C}$, $V_{SS} = -5\text{V}$, $V_{DD} = +5\text{V}$, Control Voltage = 0/ +5V, 50 Ohm System

Parameter	Min.	Typ.	Max.	Units
Frequency Range	3		6	GHz
Insertion Loss*		8	10.5	dB
Input Return Loss*		13		dB
Output Return Loss*		10		dB
Phase Error*		± 5	+15 / -25	deg
RMS Phase Error		3		deg
Insertion Loss Variation*		± 0.5		dB
Input Power for 1 dB Compression		29		dBm
Input Third Order Intercept		44		dBm
Control Voltage Current		35	250	μA
Bias Voltage Current		5	15	mA

*Note: Major States Shown

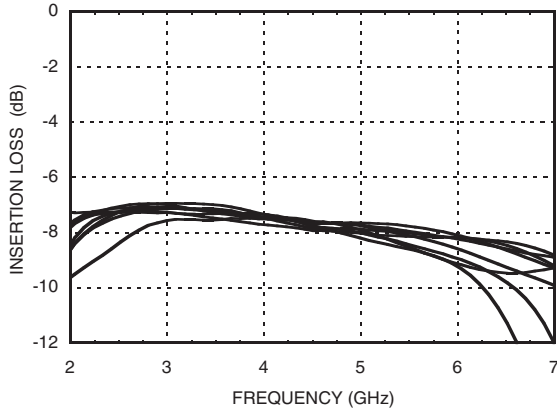
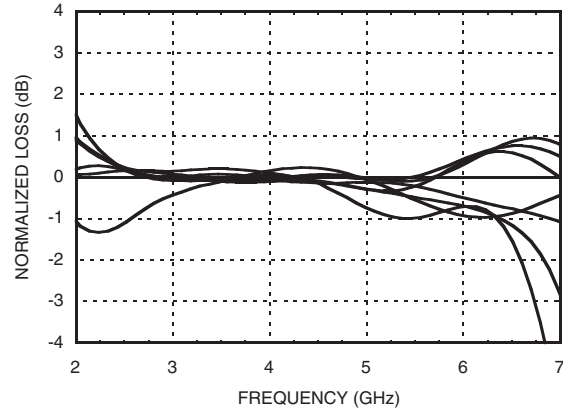
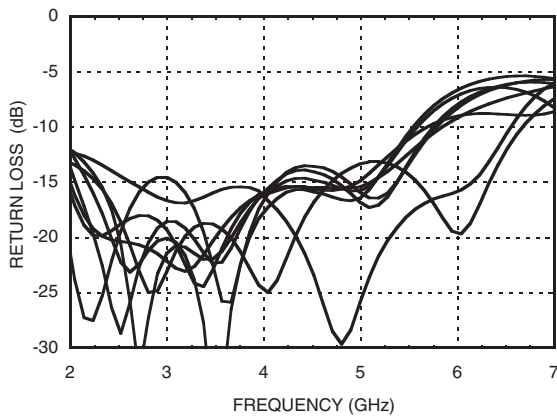
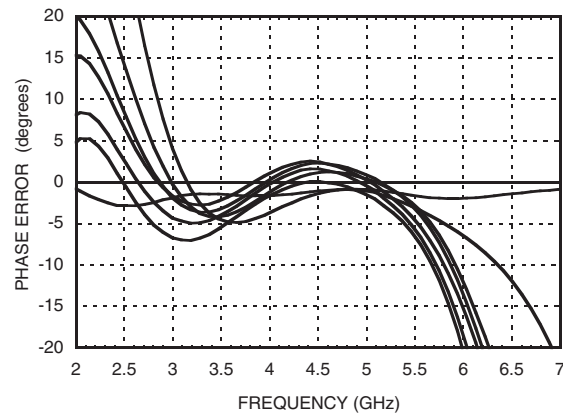
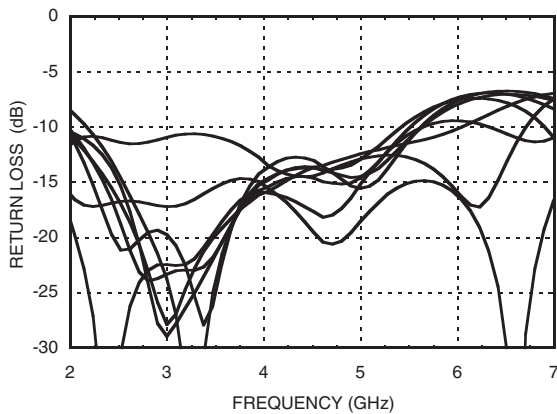
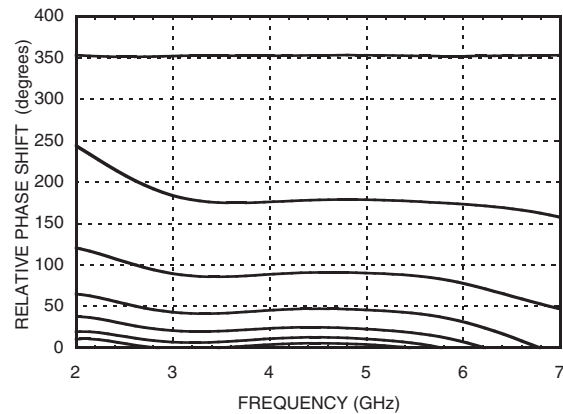
Insertion Loss, Major States Only

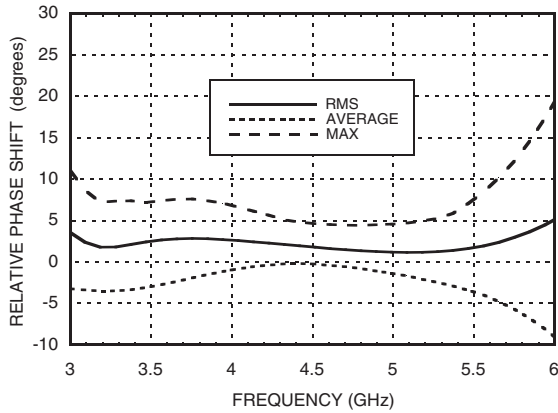
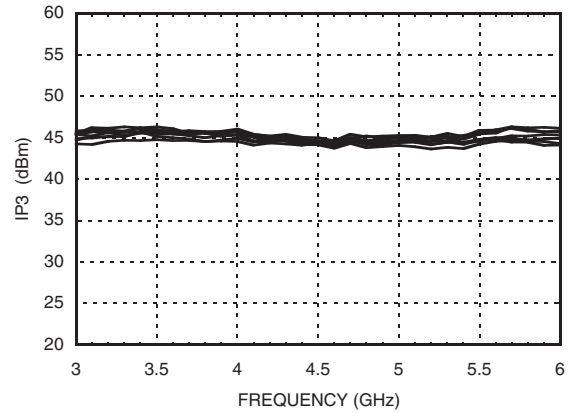
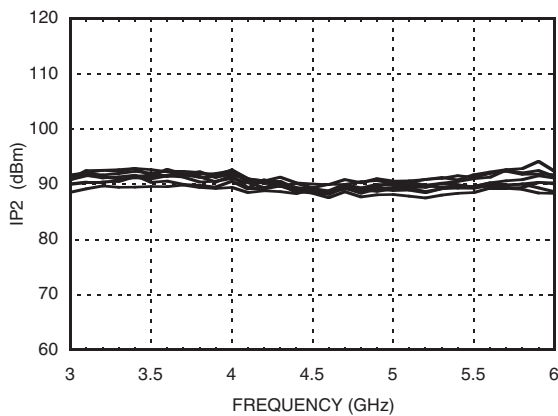
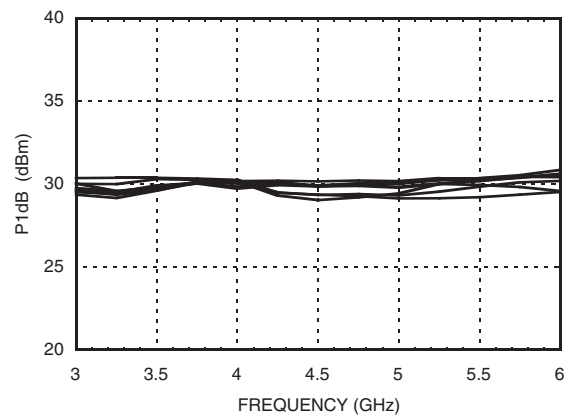
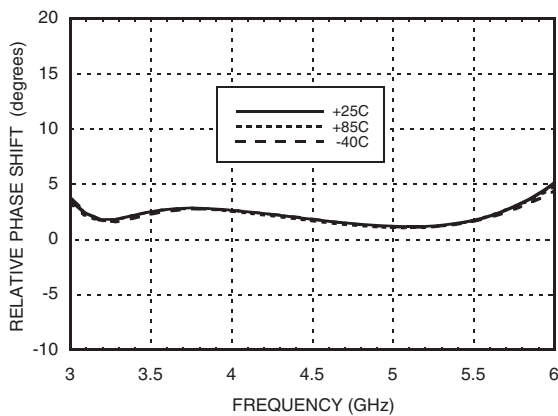
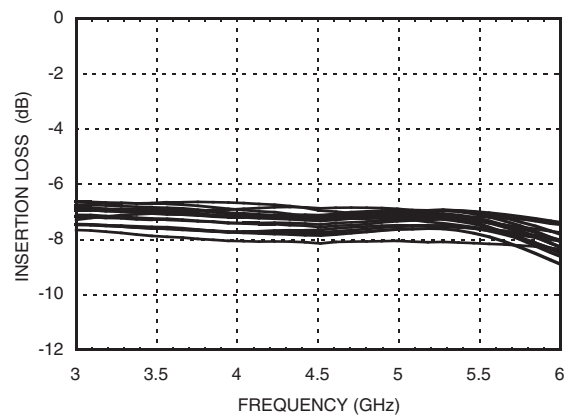
Normalized Loss, Major States Only

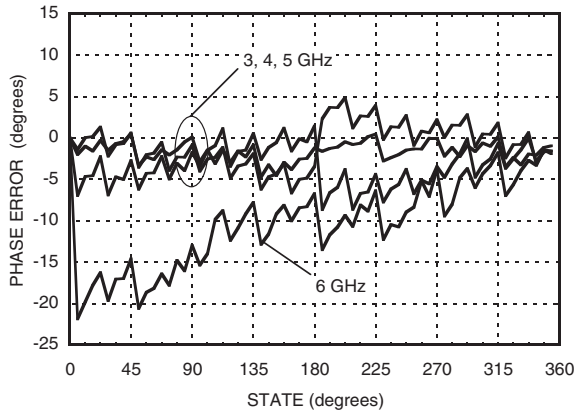
Input Return Loss, Major States Only

Phase Error, Major States Only

Output Return Loss, Major States Only

**Relative Phase Shift
 Major States Including All Bits**

**Relative Phase Shift,
RMS, Average, Max, All States**

Input IP3, Major States Only

Input IP2, Major States Only

Input P1dB, Major States Only

RMS Phase Error vs. Temperature

**Insertion Loss vs. Temperature,
Major States Only**



Phase Error vs. State

Absolute Maximum Ratings

Input Power (RFIN)	32 dBm (T= +85 °C)
Bias Voltage Range (Vdd)	-0.2 to +12V
Bias Voltage Range (Vss)	+0.2 to -12V
Channel Temperature (Tc)	150 °C
Thermal Resistance (channel to ground paddle)	160 °C/W
Storage Temperature	-65 to +150 °C
Operating Temperature	-40 to +85 °C



**ELECTROSTATIC SENSITIVE DEVICE
OBSERVE HANDLING PRECAUTIONS**

Bias Voltage & Current

Vdd	Idd
5.0	5.4mA
Vss	Iss
-5.0	5.4mA

Control Voltage

State	Bias Condition
Low (0)	0 to 0.2 Vdc
High (1)	Vdd ±0.2 Vdc @ 35 µA Typ.

Truth Table

Control Voltage Input						Phase Shift (Degrees) RFIN - RFOUT
Bit 1	Bit 2	Bit 3	Bit 4	Bit 5	Bit 6	
0	0	0	0	0	0	Reference*
1	0	0	0	0	0	5.625
0	1	0	0	0	0	11.25
0	0	1	0	0	0	22.5
0	0	0	1	0	0	45.0
0	0	0	0	1	0	90.0
0	0	0	0	0	1	180.0
1	1	1	1	1	1	354.375

Any combination of the above states will provide a phase shift approximately equal to the sum of the bits selected.

*Reference corresponds to monotonic setting

Outline Drawing

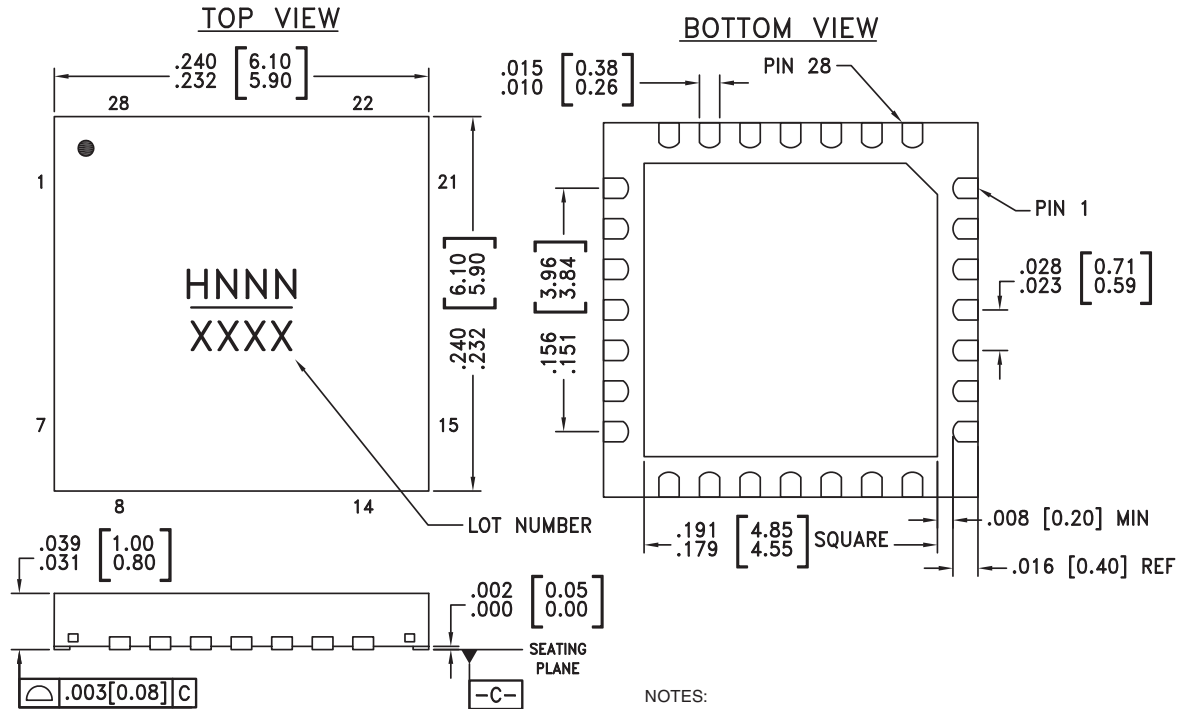





- NOTES:
1. LEADFRAME MATERIAL: COPPER ALLOY
 2. DIMENSIONS ARE IN INCHES [MILLIMETERS].
 3. DIMENSION DOES NOT INCLUDE MOLDFLASH OF 0.15mm PER SIDE.
 4. DIMENSION DOES NOT INCLUDE MOLDFLASH OF 0.25mm PER SIDE.
 5. ALL GROUND LEADS MUST BE SOLDERED TO PCB RF GROUND.
 6. CLASSIFIED AS MOISTURE SENSITIVITY LEVEL (MSL) 1.

Package Information

Part Number	Package Body Material	Lead Finish	MSL Rating	Package Marking ^[3]
HMC649LP6	Low Stress Injection Molded Plastic	Sn/Pb Solder	MSL1 ^[1]	H646 XXXX
HMC649LP6E	RoHS-compliant Low Stress Injection Molded Plastic	100% matte Sn	MSL1 ^[2]	H649 XXXX

[1] Max peak reflow temperature of 235 °C
 [2] Max peak reflow temperature of 260 °C
 [3] 4-Digit lot number XXXX

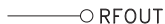
Pin Descriptions

Pin Number	Function	Description	Interface Schematic
1	Vdd	Voltage supply.	
2, 20	GND	These pins and exposed ground paddle must be connected to RF/DC ground.	
3	RFIN	This port is DC coupled and matched to 50 Ohms.	RFIN 
4 - 18	N/C	No connection required. These pins may be connected to RF/DC ground without affecting performance.	
19	RFOUT	This port is DC coupled and matched to 50 Ohms.	 RFOUT
22 - 24, 26 - 28	BIT6, BIT5, BIT4, BIT3, BIT2, BIT1	Control Input. See truth table and control voltage tables.	
25	Vss	Voltage supply.	

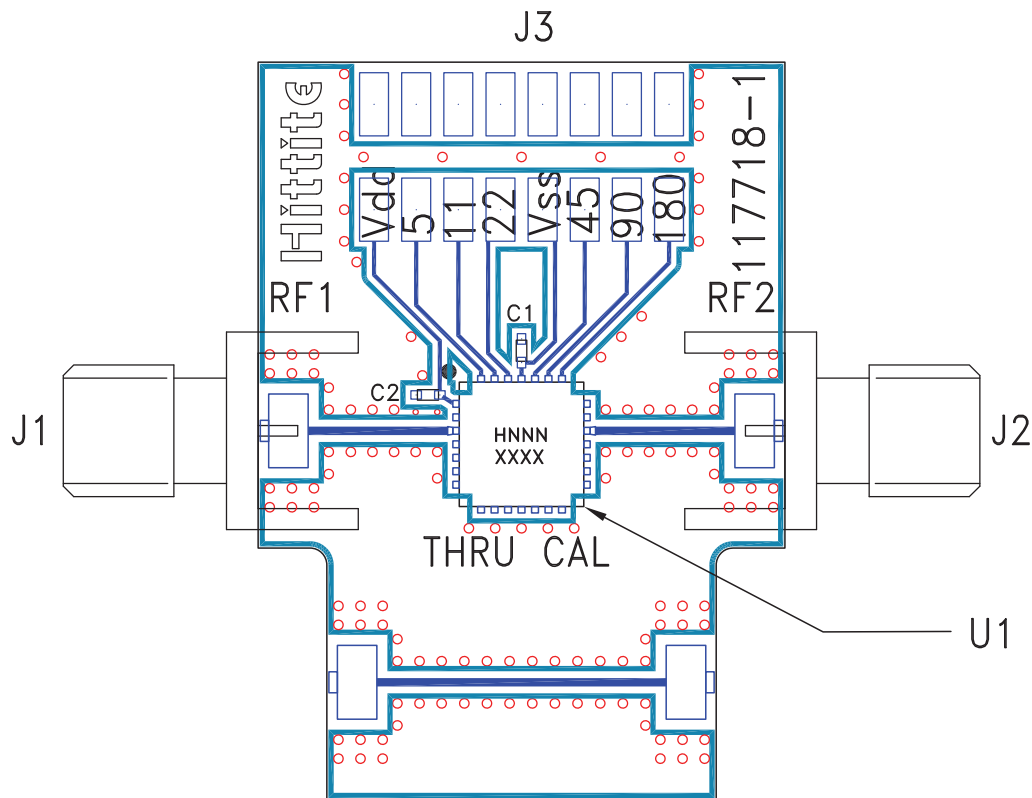
Evaluation PCB

List of Materials for Evaluation PCB 117720 [1][3]

Item	Description
J1 - J2	PCB Mount SMA RF Connector
J3	Header 2mm, 16 Pins
C1,C2	1000pF Capacitor, 0402 Pkg.
U1	HMC649LP6(E) 6-Bit Digital Phase Shifter
PCB [2]	117718 Evaluation PCB

[1] Reference this number when ordering complete evaluation PCB

[2] Circuit Board Material: Rogers 4350

[3] Please refer to part's pin description and functional diagram for pin out assignments on evaluation board.

The circuit board used in the final application should use RF circuit design techniques. Signal lines should have 50 ohm impedance while the package ground leads and exposed paddle should be connected directly to the ground plane similar to that shown. A sufficient number of via holes should be used to connect the top and bottom ground planes. The evaluation board should be mounted to an appropriate heat sink. The evaluation circuit board shown is available from Hittite upon request.



MICROWAVE CORPORATION v02.0308



HMC649LP6 / 649LP6E

**GaAs MMIC 6-BIT DIGITAL
PHASE SHIFTER, 3 - 6 GHz**

Notes: