

# PQ05RH1/PQ05RH11 Series

1.5A Output, Low Power-Loss Voltage Regulators

## Features

- Low power-loss (Dropout voltage: MAX. 0.5V)
- Compact resin full-mold package
- Built-in ON/OFF control terminal
- High-precision output (Output voltage precision:  $\pm 2.5\%$ ) (PQ05RH11 Series)

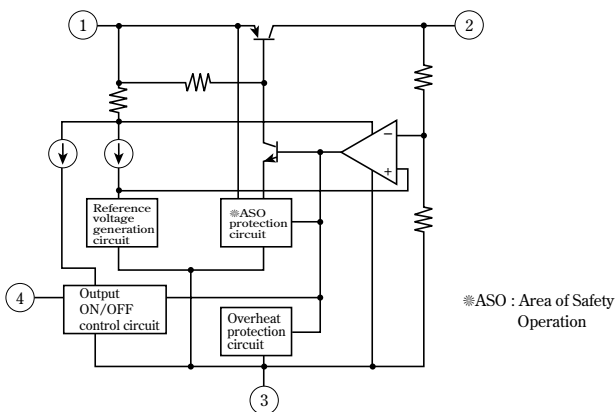
## Applications

- Series power supply for various electronic equipment such as VCRs and OA equipment.

## Model Line-ups

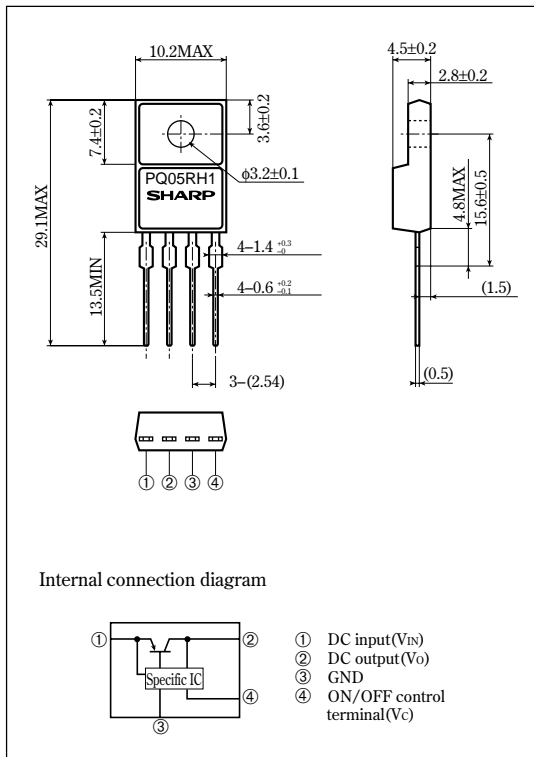
Output voltage	5V Output	9V Output	12V Output
Output voltage precision: $\pm 5\%$	PQ05RH1	PQ09RH1	PQ12RH1
Output voltage precision: $\pm 2.5\%$	PQ05RH11	PQ09RH11	PQ12RH11

## Equivalent Circuit Diagram



## Outline Dimensions

(Unit : mm)



•Please refer to the chapter " Handling Precautions ".



**Absolute Maximum Ratings**

( $T_a=25^\circ\text{C}$ )

Parameter	Symbol	Rating	Unit
*1 Input voltage	$V_{IN}$	35	V
*1 ON/OFF control terminal voltage	$V_C$	35	V
Output current	$I_o$	1.5	A
Power dissipation (No heat sink)	$P_{D1}$	1.5	W
Power dissipation (With infinite heat sink)	$P_{D2}$	18	W
*2 Junction temperature	$T_j$	150	$^\circ\text{C}$
Operating temperature	$T_{opr}$	-20 to +80	$^\circ\text{C}$
Storage temperature	$T_{stg}$	-40 to +150	$^\circ\text{C}$
Soldering temperature	$T_{sol}$	260 (For 10s)	$^\circ\text{C}$

\*1 All are open except GND and applicable terminals.

\*2 Overheat protection may operate at  $125 \leq T_j < 150^\circ\text{C}$ .

**Electrical Characteristics**

(Unless otherwise specified, condition shall be  $I_o=0.5\text{A}$ ,  $T_a=25^\circ\text{C}$ \*)

Parameter	Symbol	Conditions	MIN.	TYP.	MAX.	Unit	
Output voltage	V <sub>o</sub>	-	PQ05RH1	4.75	5.0	5.25	V
			PQ09RH1	8.55	9.0	9.45	
			PQ12RH1	11.4	12.0	12.6	
			PQ05RH11	4.88	5.0	5.12	
			PQ09RH11	8.78	9.0	9.22	
			PQ12RH11	11.7	12.0	12.3	
Load regulation	RegL	$I_o=5\text{mA}$ to 1.5A	-	0.3	2.0	%	
Line regulation	RegI	*4	-	0.5	2.5	%	
Temperature coefficient of output voltage	TcV <sub>o</sub>	$T_j=0$ to $125^\circ\text{C}$	-	$\pm 0.02$	-	$\%/^\circ\text{C}$	
Ripple rejection	RR	Refer to Figs.2	45	55	-	dB	
Dropout voltage	V <sub>f-o</sub>	*5	-	-	0.5	V	
ON-state voltage for control	V <sub>C(ON)</sub>	-	2.0 *6	-	-	V	
ON-state current for control	I <sub>C(ON)</sub>	V <sub>C</sub> =2.7V	-	-	20	$\mu\text{A}$	
OFF-state voltage for control	V <sub>C(OFF)</sub>	-	-	-	0.8	V	
OFF-state current for control	I <sub>C(OFF)</sub>	V <sub>C</sub> =0.4V	-	-	-0.4	mA	
Quiescent current	I <sub>q</sub>	$I_o=0$	-	-	10	mA	

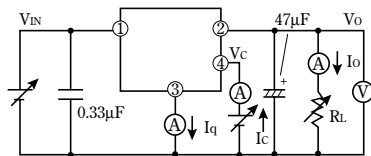
\*3 PQ05RH1 series:V<sub>IN</sub>=7V, PQ09RH1 series:V<sub>IN</sub>=15V, PQ12RH1 series:V<sub>IN</sub>=18V

\*4 PQ05RH1/PQ05RH11:V<sub>IN</sub>=6 to 12V  
 PQ09RH1/PQ09RH11:V<sub>IN</sub>=10 to 25V  
 PQ12RH1/PQ12RH11:V<sub>IN</sub>=13 to 29V

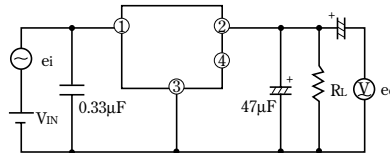
\*5 Input voltage shall be the value when output voltage is 95% in comparison with the initial value.

\*6 In case of opening control terminal ④, output voltage turns on.

**Fig.1 Test Circuit**

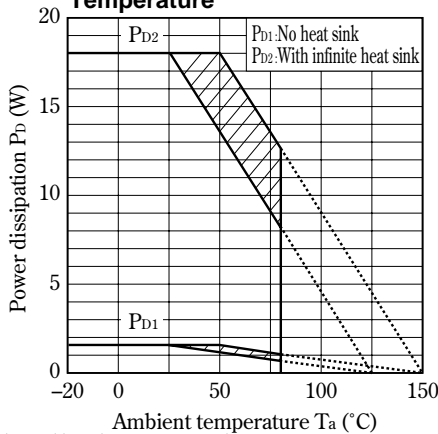


**Fig.2 Test Circuit of Ripple Rejection**



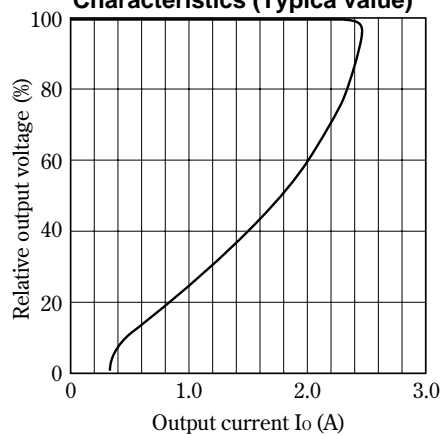
$f=120\text{Hz}$ (sine wave)  
 $e_i(\text{rms})=0.5\text{V}$   
 $RR=20 \log(e_i(\text{rms})/e_o(\text{rms}))$

**Fig.3 Power Dissipation vs. Ambient Temperature**

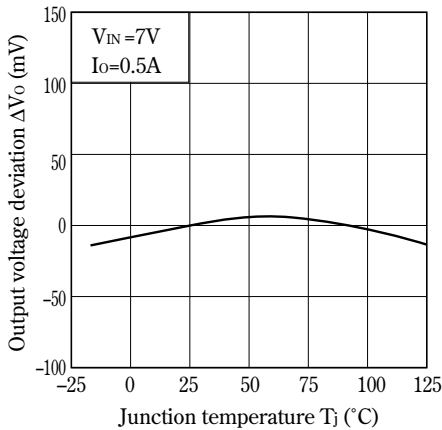


Note) Oblique line portion : Overheat protection may operate in this area.

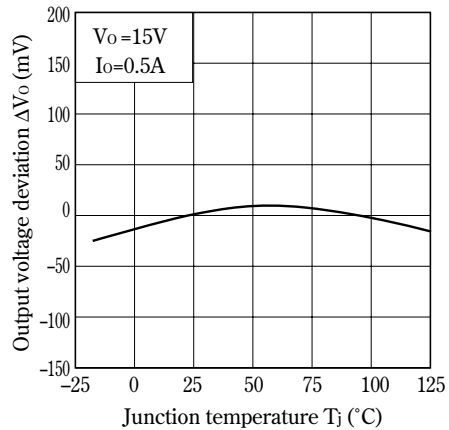
**Fig.4 Overcurrent Protection Characteristics (Typical value)**



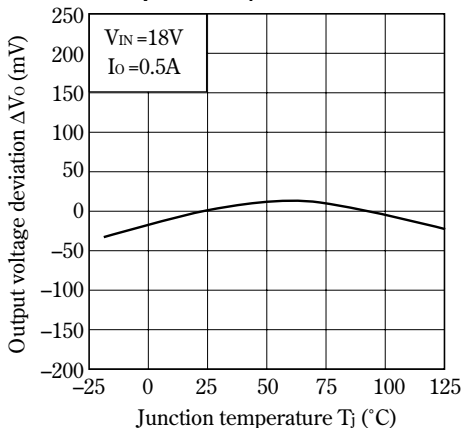
**Fig.5 Output Voltage Deviation vs. Junction Temperature (PQ05RH1/PQ05RH11)**



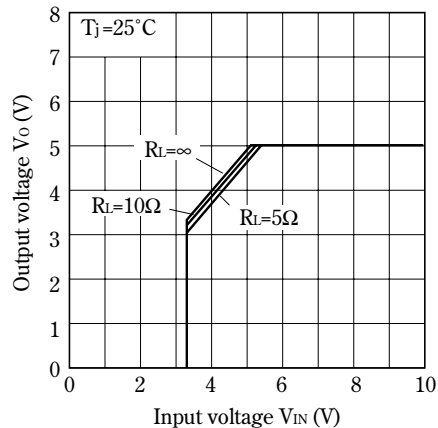
**Fig.6 Output Voltage Deviation vs. Junction Temperature (PQ09RH1/PQ09RH11)**



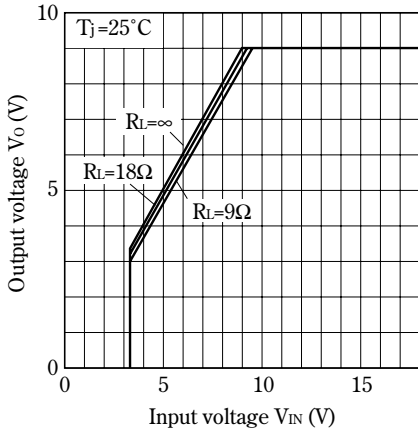
**Fig.7 Output Voltage Deviation vs. Junction Temperature (PQ12RH1/PQ12RH11)**



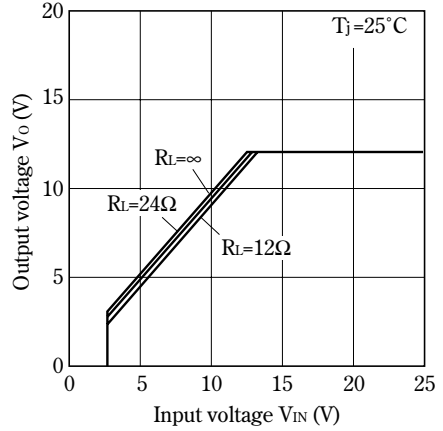
**Fig.8 Output Voltage vs. Input Voltage (PQ05RH1/PQ05RH11)**



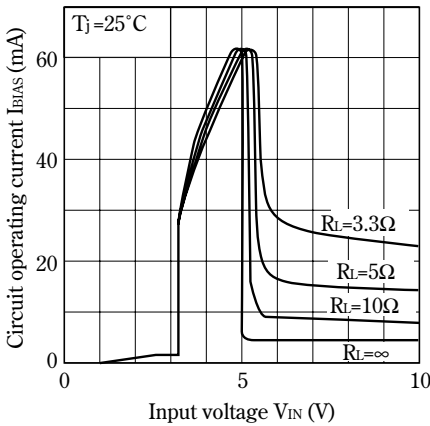
**Fig.9 Output Voltage vs. Input Voltage (PQ09RH1/PQ09RH11)**



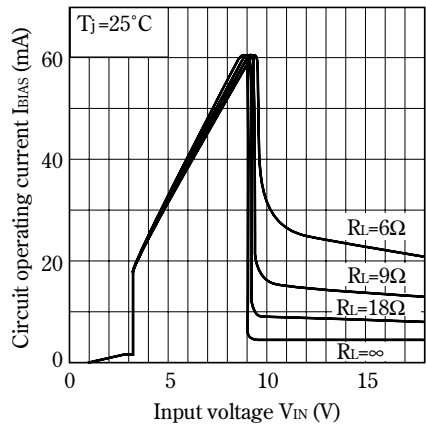
**Fig.10 Output Voltage vs. Input Voltage (PQ12RH1/PQ12RH11)**



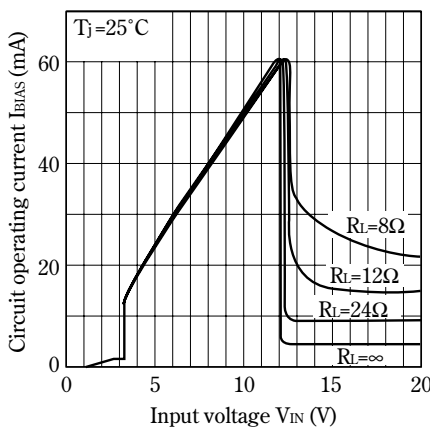
**Fig.11 Circuit Operating Current vs. Input Voltage (PQ05RH1/PQ05RH11)**



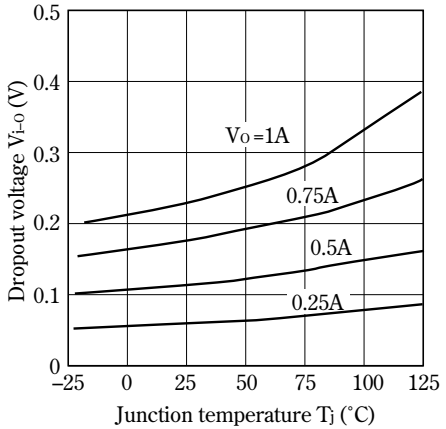
**Fig.12 Circuit Operating Current vs. Input Voltage (PQ09RH1/PQ09RH11)**



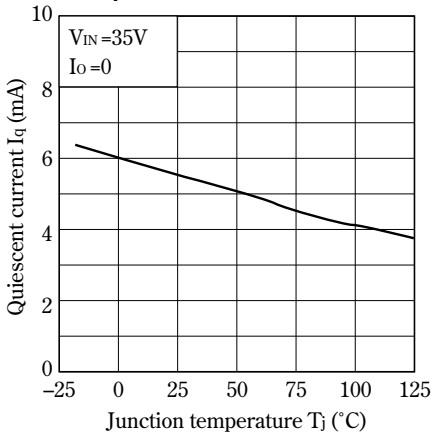
**Fig.13 Circuit Operating Current vs. Input Voltage (PQ12RH1/PQ12RH11)**



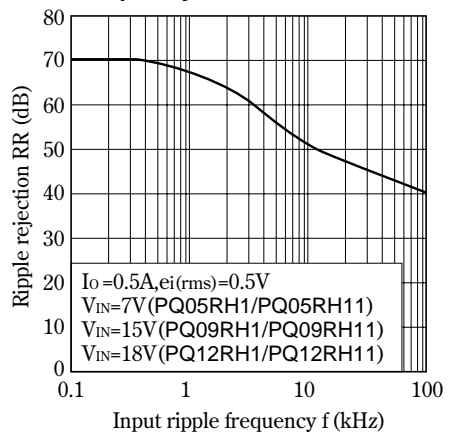
**Fig.14 Dropout Voltage vs. Junction Temperature**



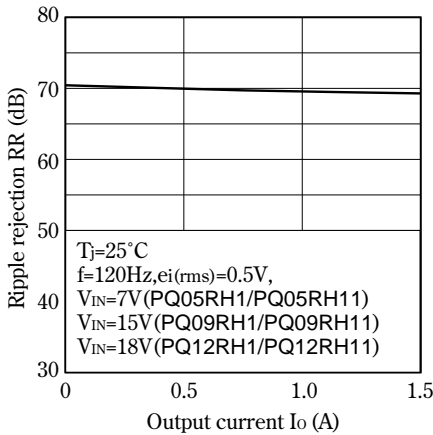
**Fig.15 Quiescent Current vs. Junction Temperature**



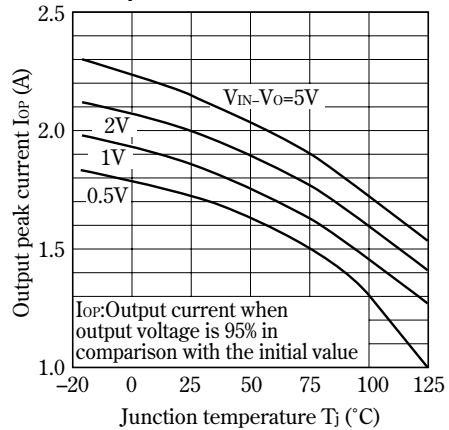
**Fig.16 Repple Rejection vs. Input Ripple Frequency**



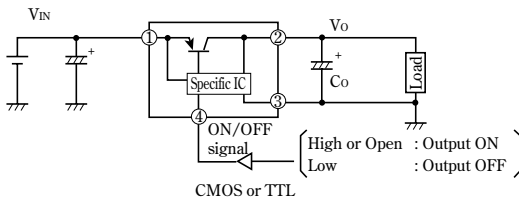
**Fig.17 Ripple Rejection vs. Output Current**



**Fig.18 Output Peak Current vs. Junction Temperature**



■ Typical Application

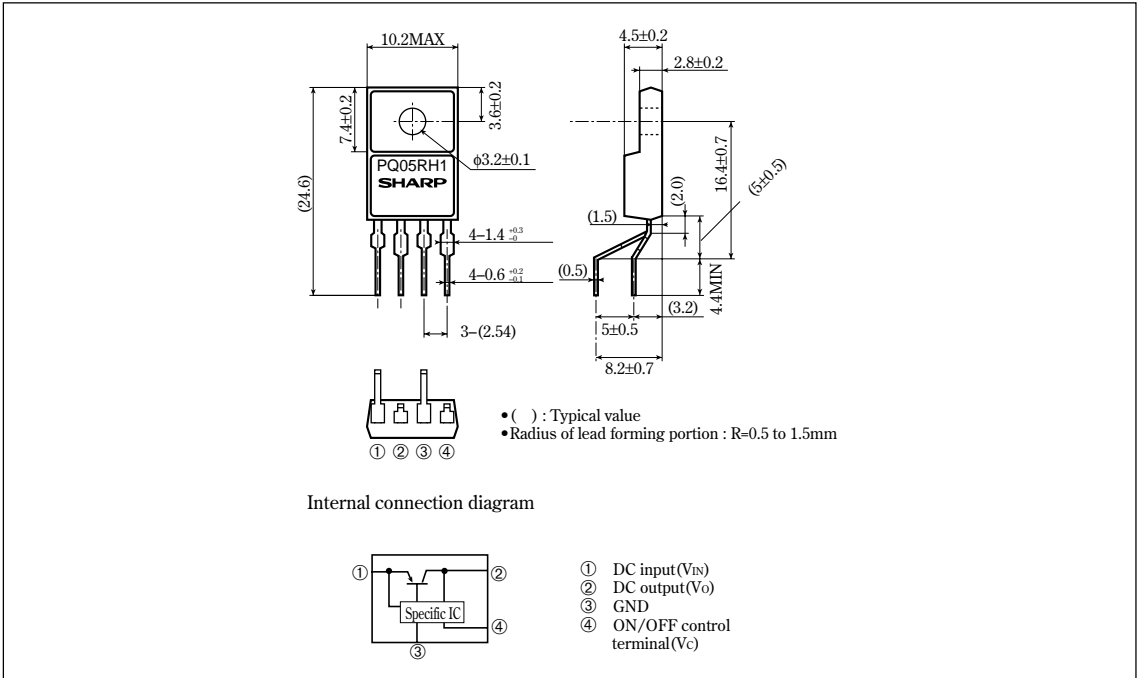


Model Line-ups for Lead Forming Type

Output voltage	5V Output	9V Output	12V Output
Output voltage precision:±5%	PQ05RH1A	PQ09RH1A	PQ12RH1A
Output voltage precision:±2.5%	PQ05RH1B	PQ09RH1B	PQ12RH1B

Outline Dimensions (PQ05RH1A/PQ05RH1B Series)

(Unit : mm)



Note)The value of absolute maximum ratings and electrical characteristics is same as ones of PQ05RH1/11 series.

## NOTICE

- The circuit application examples in this publication are provided to explain representative applications of SHARP devices and are not intended to guarantee any circuit design or license any intellectual property rights. SHARP takes no responsibility for any problems related to any intellectual property right of a third party resulting from the use of SHARP's devices.
- Contact SHARP in order to obtain the latest device specification sheets before using any SHARP device. SHARP reserves the right to make changes in the specifications, characteristics, data, materials, structure, and other contents described herein at any time without notice in order to improve design or reliability. Manufacturing locations are also subject to change without notice.
- Observe the following points when using any devices in this publication. SHARP takes no responsibility for damage caused by improper use of the devices which does not meet the conditions and absolute maximum ratings to be used specified in the relevant specification sheet nor meet the following conditions:
  - (i) The devices in this publication are designed for use in general electronic equipment designs such as:
    - Personal computers
    - Office automation equipment
    - Telecommunication equipment [terminal]
    - Test and measurement equipment
    - Industrial control
    - Audio visual equipment
    - Consumer electronics
  - (ii) Measures such as fail-safe function and redundant design should be taken to ensure reliability and safety when SHARP devices are used for or in connection with equipment that requires higher reliability such as:
    - Transportation control and safety equipment (i.e., aircraft, trains, automobiles, etc.)
    - Traffic signals
    - Gas leakage sensor breakers
    - Alarm equipment
    - Various safety devices, etc.
  - (iii) SHARP devices shall not be used for or in connection with equipment that requires an extremely high level of reliability and safety such as:
    - Space applications
    - Telecommunication equipment [trunk lines]
    - Nuclear power control equipment
    - Medical and other life support equipment (e.g., scuba).
- Contact a SHARP representative in advance when intending to use SHARP devices for any "specific" applications other than those recommended by SHARP or when it is unclear which category mentioned above controls the intended use.
- If the SHARP devices listed in this publication fall within the scope of strategic products described in the Foreign Exchange and Foreign Trade Control Law of Japan, it is necessary to obtain approval to export such SHARP devices.
- This publication is the proprietary product of SHARP and is copyrighted, with all rights reserved. Under the copyright laws, no part of this publication may be reproduced or transmitted in any form or by any means, electronic or mechanical, for any purpose, in whole or in part, without the express written permission of SHARP. Express written permission is also required before any use of this publication may be made by a third party.
- Contact and consult with a SHARP representative if there are any questions about the contents of this publication.