



## High-Power & Low-Voltage Stereo Audio Power Amplifier with 3D Surround

### ■ GENERAL DESCRIPTION

The **NJU7085** is a stereo audio power amplifier with surround sound technology for portable applications. No external coupling capacitors are required because of the differential outputs. The closed loop gain is adjusted by two external resistors. And the standby mode control reduces the supply current.

The **NJU7085** contains pop & click noise protection circuitry which eliminates noises during turn-on and turn-off transitions and RF rectification canceling circuitry.

It is suitable for portable telephone, wireless telephone, button telephone, and other speaker amplifier applications.

### ■ PACKAGE OUTLINE



**NJU7085V**

### ■ APPLICATION

- Portable DVD/TV
- Cradle Speaker
- Mobile-phone/PHS

### ■ FEATURES

- |   |                         |                               |
|---|-------------------------|-------------------------------|
| ● Operating Voltage                             | $V^+ = 2.8$ to $5.5V$   |                               |
| ● Operating Current                             | $I_{DD1} = 4.6$ mA typ. | (Mobile mode)                 |
| ● Supply Current in Power Down Mode             | $I_{DD4} = 2\mu A$ max. | (Standby mode)                |
| ● Output Power                                  | $P_o = 400$ mW/ch typ.  | ( $V^+ = 3V, R_L = 4\Omega$ ) |
| ● Low Output Noise                              | $25\mu V_{rms}$ typ.    |                               |
| ● Variable Surround Effect by external resistor |                         |                               |
| ● Standby function                              |                         |                               |
| ● Mute Function                                 |                         |                               |
| ● C-MOS Technology                              |                         |                               |
| ● Package Outline                               | SSOP32                  |                               |

### ■ BLOCK DIAGRAM

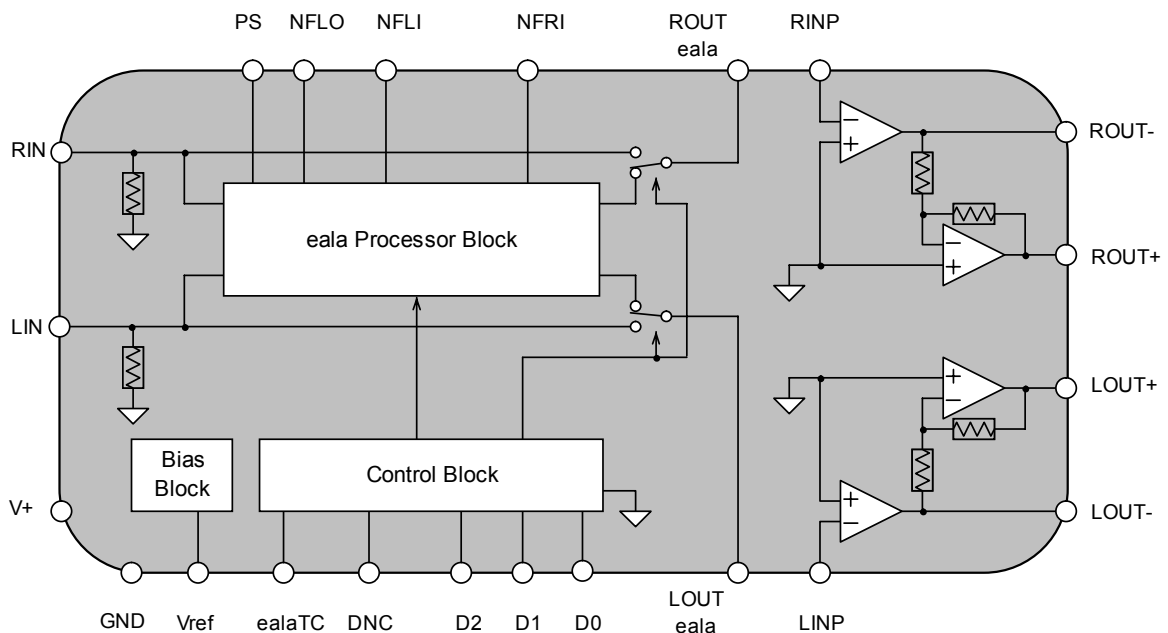

# NJU7085

www.DataSheet4U.com

## ■ PIN CONFIGURATION

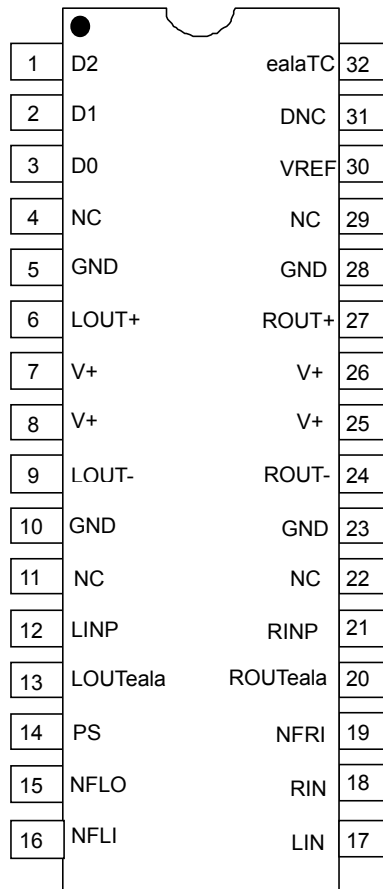

No.	Symbol	Function	No.	Symbol	Function
1	D2	Mode Control Switch 2	17	LIN	Lch Input
2	D1	Mode Control Switch 1	18	RIN	Rch Input
3	D0	Mode Control Switch 0	19	NFRI	Filter
4	NC	-	20	ROUTeala	eala processor Rch Output
5	GND	GND	21	RINP	Power Amp Rch Output
6	LOUT+	Lch+ Output	22	NC	-
7	V+	Power Supply	23	GND	GND
8	V+	Power Supply	24	ROUT-	Rch- Output
9	LOUT-	Lch- Output	25	V+	Power Supply
10	GND	GND	26	V+	Power Supply
11	NC	-	27	ROUT+	Rch+ Output
12	LINP	Power Amp Lch Input	28	GND	GND
13	LOUTeala	eala Processor Lch output	29	NC	-
14	PS	Filter	30	VREF	Reference Voltage
15	NFLO	Filter	31	DNC	Do Not Connect
16	NFLI	Filter	32	ealaTC	Filter

\*All power supply pin should be connected.

### ■ ABSOLUTE MAXIMUM RATINGS (Ta=25°C)

PARAMETER	SYMBOL	RATINGS	UNIT
Supply Voltage	V <sup>+</sup>	+7	V
Power Dissipation	P <sub>D</sub>	950* <sup>1)</sup> (SSOP32) 1500* <sup>2)</sup> (SSOP32)	mW
Output Peak Current	I <sub>o</sub>	500	mA
Operating Temperature Range	T <sub>opr</sub>	-40 to +85	°C
Storage Temperature Range	T <sub>stg</sub>	-40 to +150	°C

\*<sup>1)</sup> EIA/JEDEC STANDARD Test board (76.2 x 114.3 x 1.6mm, 2layers, FR-4) mounting

\*<sup>2)</sup> EIA/JEDEC STANDARD Test board (76.2 x 114.3 x 1.6mm, 4layers, FR-4) mounting

Junction Temperature:

$T_j = \theta_{ja} \text{ (Thermal Resistance)} \times P_d \text{ (Power Dissipation on your application)} \times T_a \text{ (Ambient Temperature)}$

We recommend to set T<sub>j</sub> as a guidepost for 0.8 times of the storage maximum temperature.

### ■ RECOMMENDED OPERATING VOLTAGE RANGE (Ta=25°C)

PARAMETER	SYMBOL	TEST CONDITION	MIN.	TYP.	MAX.	UNIT
Operating Voltage Range	V <sup>+</sup>	-	2.8	3.0	5.5	V

### ■ ELECTRICAL CHARACTERISTICS (Ta=25°C, V<sup>+</sup>=3V, Unless otherwise specified)

PARAMETER	SYMBOL	TEST CONDITION	MIN.	TYP.	MAX.	UNIT
Operating Current	I <sub>DD1</sub>	No signal, R <sub>L</sub> =∞, Mobile mode	-	4.6	8.0	mA
	I <sub>DD2</sub>	No signal, R <sub>L</sub> =∞, Mute mode	-	4.6	8.0	mA
	I <sub>DD3</sub>	No signal, R <sub>L</sub> =∞, Charge mode	-	200	400	μA
	I <sub>DD4</sub>	No signal, R <sub>L</sub> =∞, STBY mode	-	-	2.0	μA
Reference Voltage	V <sub>ref</sub>	-	1.27	1.5	1.72	V

### ● AC Characteristics

(Ta=25°C, V<sup>+</sup>=3V, G<sub>V</sub>=6dB, V<sub>IN</sub>=-20dBV, f=1kHz, R<sub>L</sub>=4Ω, BW=400Hz to 30kHz, Bypass mode, unless otherwise specified)

PARAMETER	SYMBOL	TEST CONDITION	MIN.	TYP.	MAX.	UNIT
Maximum Input Voltage	V <sub>IM1</sub>	THD=1%	-	-4.0 (630)	-	dBV (mVrms)
	V <sub>IM2</sub>	THD=1%, f=100Hz, eala mode Lin→Lout, R1+R2=4.7kΩ	-	-21.4 (85)	-	
Output Noise Voltage	V <sub>NO1</sub>	Rg=0Ω, A-weighted	-	-92 (25.1)	-	dBV (μVrms)
	V <sub>NO2</sub>	Rg=0Ω, A-weighted, eala mode	-	-90 (31.6)	-	
Total Harmonic Distortion (THD+N)	THD1	Po=200mW	-	0.1	-	%
	THD2	Po=200mW, eala mode	-	0.1	-	
Bypass Gain	G <sub>VBY</sub>	Bypass mode	5.0	6.0	7.0	dB
Surround Gain 1	G <sub>VSUR1</sub>	V <sub>IN</sub> =-26dBV, f=100Hz, Lin→Lout, eala mode, R1+R2=4.7kΩ	17.5	20.5	23.5	dB
Surround Gain 2	G <sub>VSUR2</sub>	f=100Hz, Lin→Lout, eala mode R1+R2=54.7kΩ	6.5	8.5	10.5	dB
Surround Gain 3	G <sub>VSUR3</sub>	V <sub>IN</sub> =-26dBV, f=100Hz, Lin→Lout, Mobile mode, R1+R2=4.7kΩ	17.5	20.5	23.5	dB
Surround Gain 4	G <sub>VSUR4</sub>	f=100Hz, Lin→Lout, Mobile mode, R1+R2=54.7kΩ	6.5	8.5	10.5	dB

# NJU7085

www.DataSheet4U.com

## ● AC Characteristics

( $T_a=25^\circ\text{C}$ ,  $V^+=3\text{V}$ ,  $G_v=6\text{dB}$ ,  $V_{IN}=-20\text{dBV}$ ,  $f=1\text{kHz}$ ,  $R_L=4\Omega$ ,  $BW=400\text{Hz}$  to  $30\text{kHz}$ , Bypass mode, unless otherwise specified)

PARAMETER	SYMBOL	TEST CONDITION	MIN.	TYP.	MAX.	UNIT
Output Power	$P_o$	THD $\leq$ 2%, $G_v=12\text{dB}$	320	400	-	mW
Power Supply Rejection Ratio	PSRR	Vripple=1kHz/100mVrms	-	55	-	dB
Mute Attenuation	MAT1	Mute mode	-	-95	-	dB
	MAT2	STBY mode	-	-130	-	dB
Channel Separation	CS	$R_S=600\Omega$ , $V_O=1\text{Vrms}$ , $f=1\text{kHz}$ , A-weighted	-	70	-	dB
Input Resistance	$R_{IN}$	LIN, RIN Terminal	-	100	-	k $\Omega$
	$R_{MODE}$	Mode Control Terminal	10	-	-	
Output Offset Voltage	$V_{OD}$	$V_{IN}=0\text{V}$	-60	-	60	mV

## ● Mode Control ( $T_a=25^\circ\text{C}$ , $V^+=3\text{V}$ )

PARAMETER	SYMBOL	TEST CONDITION	MIN.	TYP.	MAX.	UNIT
High Level Input Voltage	$V_{IH}$	-	0.7V <sup>+</sup>	-	V <sup>+</sup>	V
Low Level Input Voltage	$V_{IL}$	-	0	-	0.25	

## ■ CONTROL TERMINAL EXPLANATION

### ● MUTE/Standby Mode Control (MUTE, STBY Terminal)

Operation Mode	D2	D1	D0	NOTE
STBY	L	L	L	IC is non-active
Charge	H	L	L	Reference Voltage Charge mode
MUTE	H	L	H	Non output signal
Bypass	L	H	H	INPUT through
eala	L	L	H	eala-ON
Mobile	H	H	H	eala Mobile-ON
Inhibited Setting	Except for above			-

## ■ TERMINAL DESCRIPTION (SSOP32)

PIN No.	SYMBOL	FUNCTION	EQUIVALENT CIRCUIT	TERMINAL DC VOLTAGE
1 2 3	D2 D1 D0	Mode Control Switch		
7,8, 25,26  5,10, 23,28	V+  GND	Power  GND		V+  0
6 9 24 27	LOUT+ LOUT- ROUT- ROUT+	Lch+ Output Lch- Output Rch- Output Rch+ Output		V+/2
12 21	LINP RINP	Lch Input to Power Amp Rch Input to PowerAmp		V+/2

# NJU7085

www.DataSheet4U.com

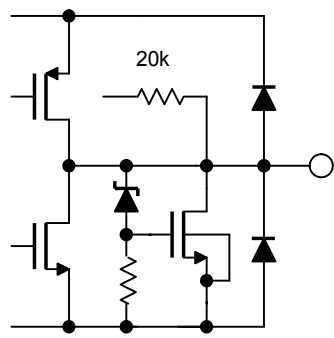
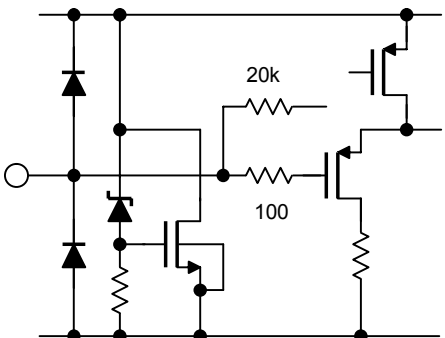
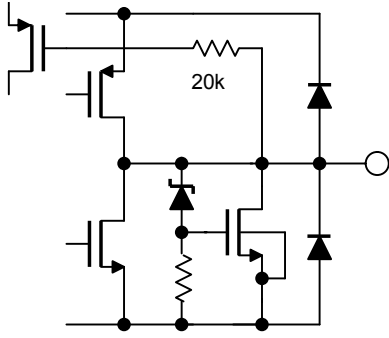
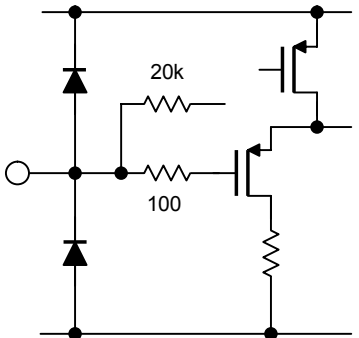
PIN No.	SYMBOL	FUNCTION	EQUIVALENT CIRCUIT	TERMINAL DC VOLTAGE
13 20	LOUTEala ROUTEala	Lch Input to eala Processer Rch Input to eala Processer		V+/2
14	PS	Filter		V+/2
15	NFLO	Filter		V+/2
16 19	NFLI NFRI	Filter		V+/2

PIN No.	SYMBOL	FUNCTION	EQUIVALENT CIRCUIT	TERMINAL DC VOLTAGE
17 18	LIN RIN	Lch Input Rch Input		V+/2
30	Vref	Reference Voltage		V+/2
32	ealaTC	Filter		
4,11 22,29	NC	No Connection		
31	DNC	Do Not Connection		

# NJU7085

www.DataSheet4U.com

## APPLICATION CIRCUIT

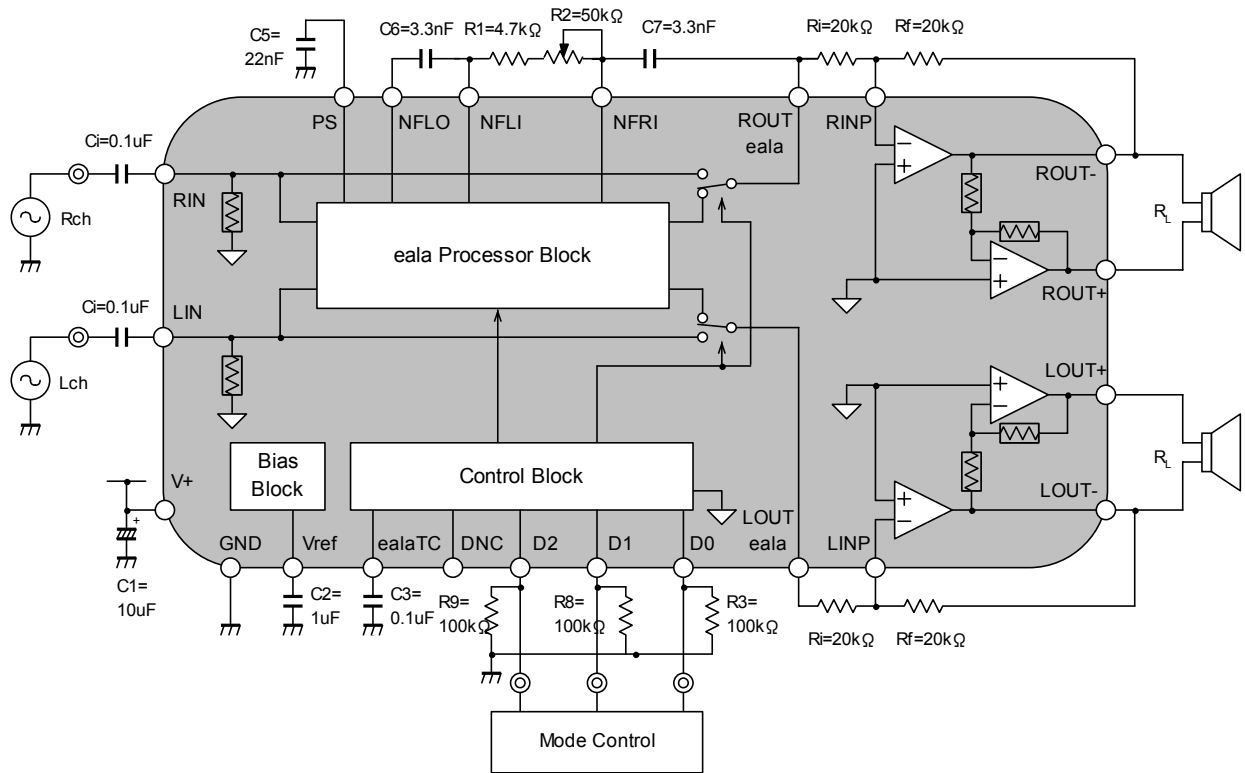



## APPLICATION NOTES

The **NJU7085** is high power ( $P_o=400\text{mW/ch typ.}$ ) and low operating voltage (2.8V to) stereo audio power amplifier with surround sound technology for cellular phones and portable equipments.

The external coupling capacitors are not necessary because of the differential outputs.

The closed loop gain is set 0 to 43dB by selecting the ratio of  $R_i$  to  $R_f$ .

The **NJU7085** contains 6-mode: Bypass mode (Input through), eala mode (stereo surround), eala Mobile mode (surround for narrow space speaker), STBY mode (IC is non-active), charge mode (Reference Voltage Charge mode), MUTE mode (Non output signal).

The **NJU7085** includes pop noise protection circuit eliminating noises during turn-on and turn-off transitions.

### 1. Notice

- 1.1 The **NJU7085** may be not effective for a sound without the reverberation such as FM and monaural signal source.
- 1.2 eala Mobile mode may be not effective in the system that speaker distance is more than 20 cm. In this case, we recommend eala mode.
- 1.3 **NJU7085** includes RF rectification canceling circuit, but please confirm it by an enough examination in your actual application.

### 2. Operation Outline

Fig.1 shows the block diagram of **NJU7085**.

It consists of eala surround block, power amp block, bias block, thermal shutdown block, control block.

The surround effect can be adjusted with eala effect volume (external resistor:  $R_2$ ).

Two external resistors adjust the closed loop gain ( $R_i$ ,  $R_f$ ).

The standby function contributes to low consumption by suspending all circuits.

Charge mode allows start time to shorten because of the external reference capacitor( $C_2$ ) charged rapidly.

By using external capacitors  $C_2$ ,  $C_3$ , The **NJU7085** reduces pop noise during turn-on and turn-off transitions. Please refer to captor 3 detail of Pop noise.

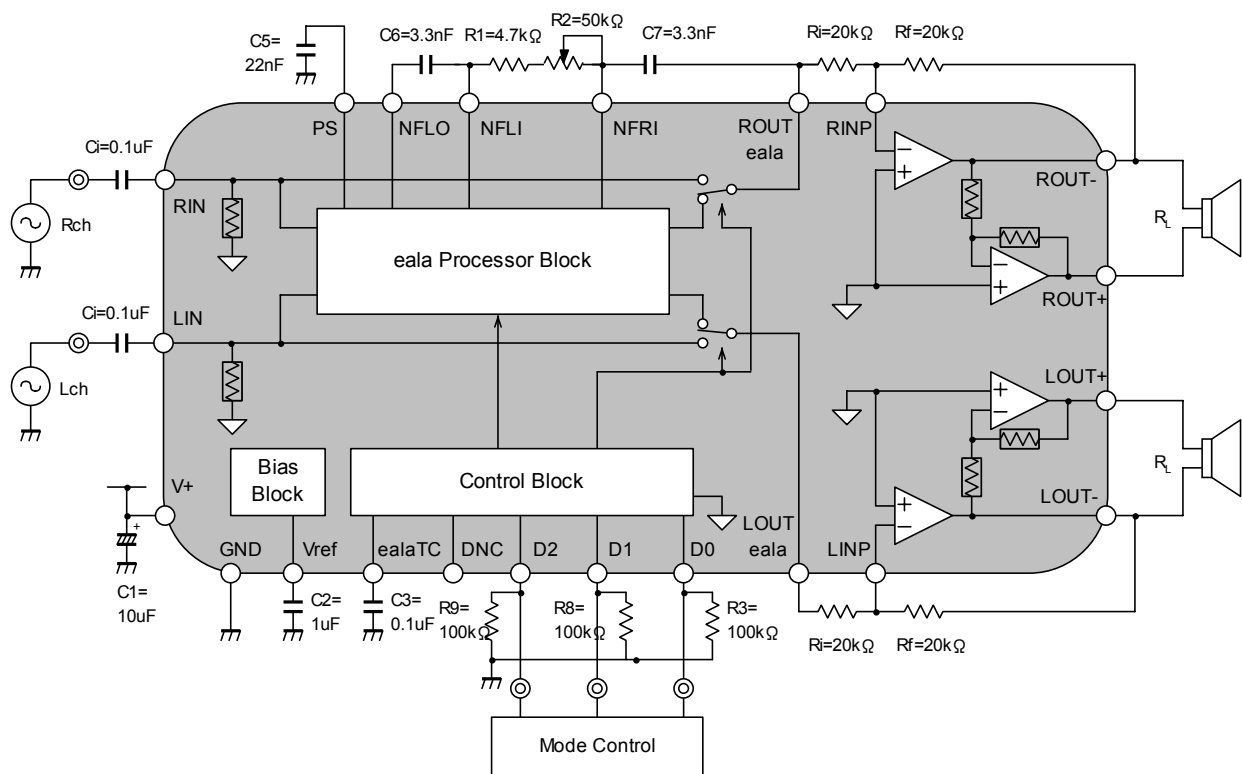

Fig.1 Block Diagram

## 2.1 External parts

### 2.1.1 power supply bypassing capacitor

Select C1 which is enough good thermal characteristics and high frequency characteristics. The wiring pattern between C1 and IC should be shortened to prevent the generating of wiring resistance.

### 2.1.2 Input coupling capacitor

The input impedance and input coupling capacitor (Ci) form a high pass filter which limits low frequency response. The input impedance is designed about 100kΩ.

### 2.1.3 Input resistance (Ri) and feedback resistance (Rf) of power amplifier.

The closed loop gain is adjusted by Ri and Rf .

It is given by the following equation.

$$G_v = 20 \text{LOG}(2R_f/R_i) = 6 \text{ [dB]}$$

The closed loop gain should be set from 0dB to +43dB.

### 2.1.4 Reference voltage bypassing capacitor

Reference voltage bypassing capacitor (C2) affects PSRR (See Fig.2).

### 2.1.5 eala effect volume

The surround effect is able to adjust with eala effect volume (R2).

It is able to replace to fixed resistor (R1+R2) if you select constant surround effect.

### 2.1.6 eala TC capacitor

eala TC capacitor (C3) reduces pop noise at the time of changing the mode setting (Bypass↔eala, Bypass↔Mobile, eala ↔Mobile).

The pop noise becomes smaller with using large capacitor.

### 2.1.7 PS capacitor

PS capacitor (C5) affects phase characteristics on eala Mobile mode.

In case of canceling L/R sound, it is able to compensate with using small capacitor.

### 2.1.8 Control terminal (D0,D1,D2) resistance

Control terminal resistances (R3, R8, R9) reduce pop noise at the time of changing mode control.

### 2.1.9 PSRR (Power Supply Rejection Ratio) vs. C2

Large bypassing capacitor (C2) improves PSRR shown in Fig.2.

But a large input coupling capacitor requires more charge time to reach its quiescent DC voltage.

Select C2 in consideration of PSRR and pop noise.

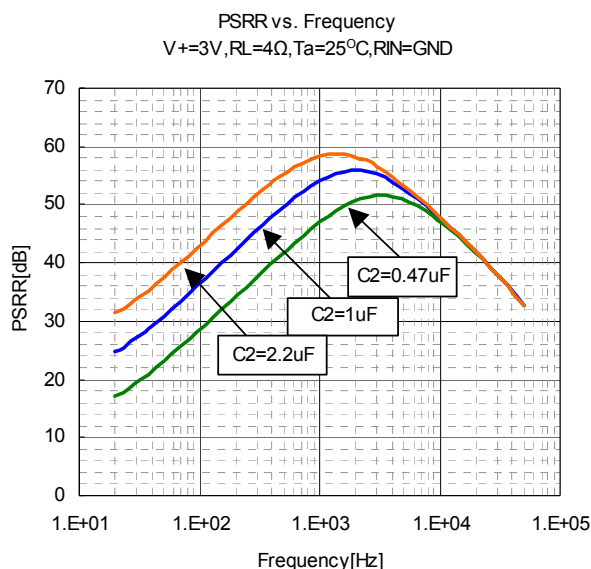

Fig.2 PSRR vs. Frequency

2.2 Operation explanation

2.2.1 Bypass Mode

Fig.2 shows the signal channel at bypass mode.

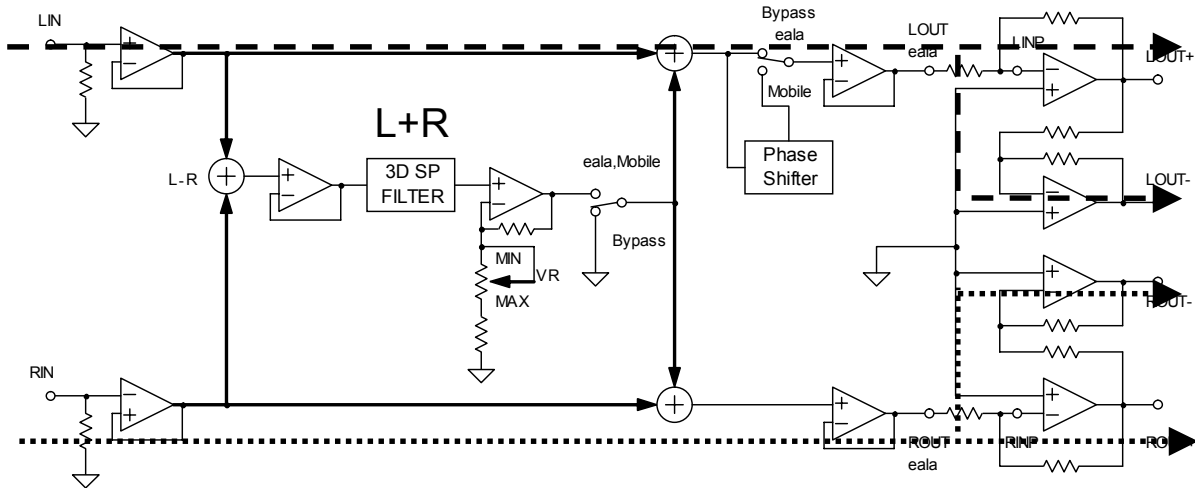

Fig.2 Bypass Mode

2.2.2 eala Mode

Fig.3 shows the signal channel at eala mode.

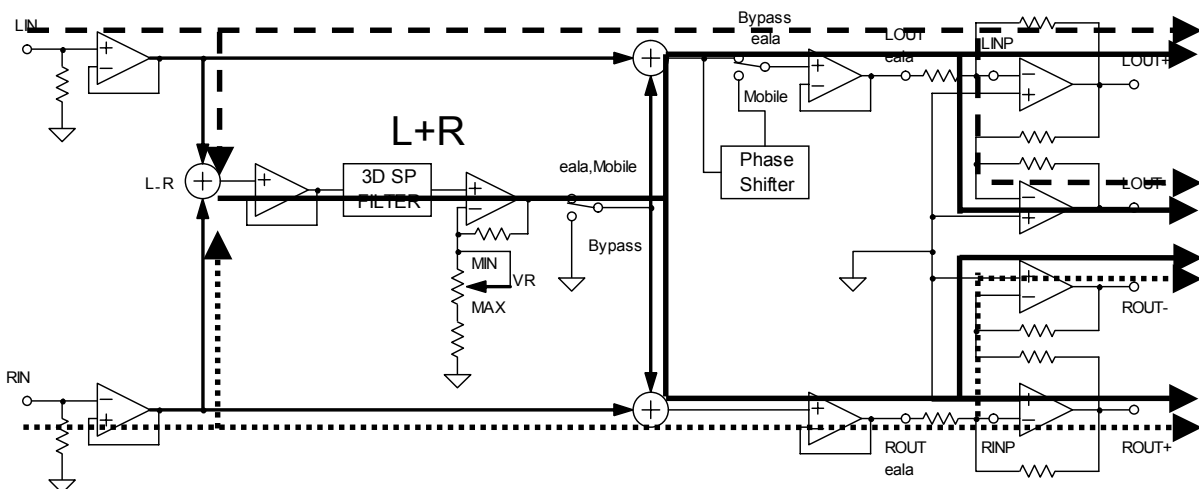

Fig.3 eala Mode

## 2.2.3 ealaMobile Mode

Fig.4 shows the signal channel at eala Mobile mode.

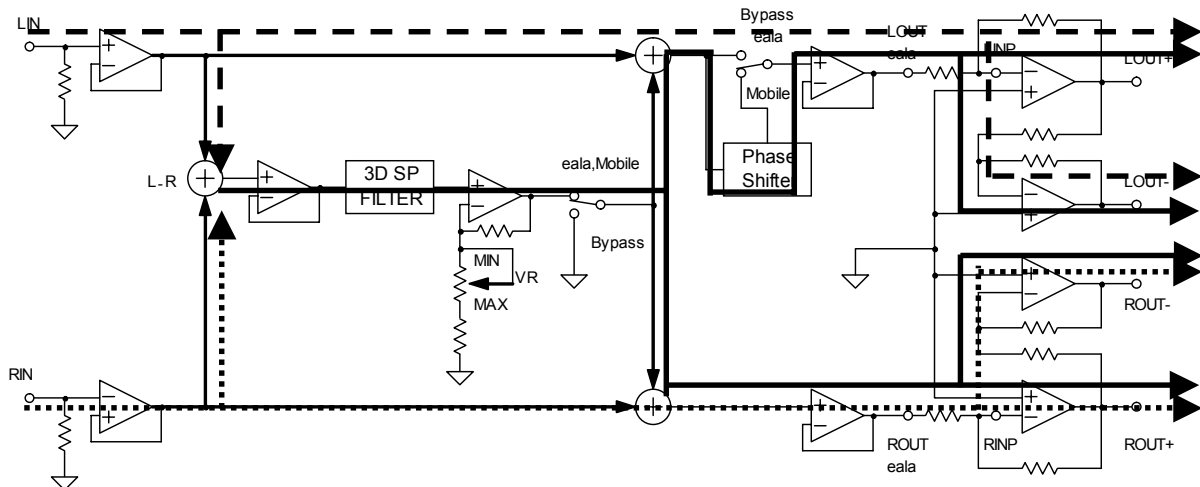

Fig.4 Mobile Mode

### 3 Power ON/OFF and pop noise during turn-on and turn-off transitions.

The NJU7085 reduces pop noise by using capacitor for charge & discharge. The following shows tips of reducing pop noise.

#### 3.1 Power Supply ON/OFF

Power ON/OFF should be changed on the STBY mode (D0,D1,D2=L,L,L)

#### 3.2 STBY → Active (Bypass /eala /Mobile mode)

The recommendation sequence is described as follows.

STBY (L,L,L) → Charge (L,L,H) → MUTE (H,L,H) → each mode

It should be provided the charge time of at least 50 msec for reducing pop noise under application circuit condition (C2=1μF).

The charge time is given by the following equation.

$$T = 5 \times C2 \times 100k [S]$$

#### 3.3 Active (Bypass /eala /Mobile mode) → STBY

The recommendation sequence is described as follows.

Each mode → Mute (H,L,H) → STBY (L,L,L)

## TYPICAL CHARACTERISTICS

Reference Voltage vs. Operating Voltage  
Ta=25°C

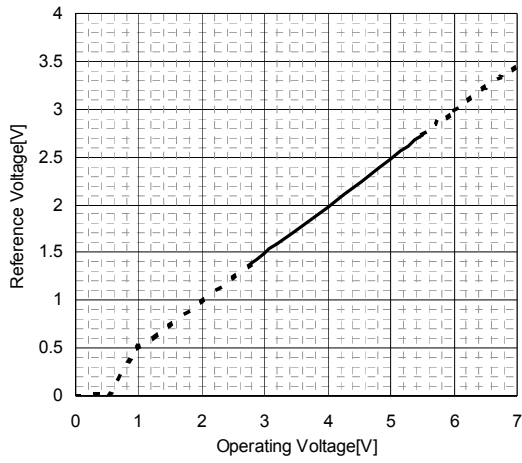

Reference Voltage vs. Ambient Temperature  
V+=3V

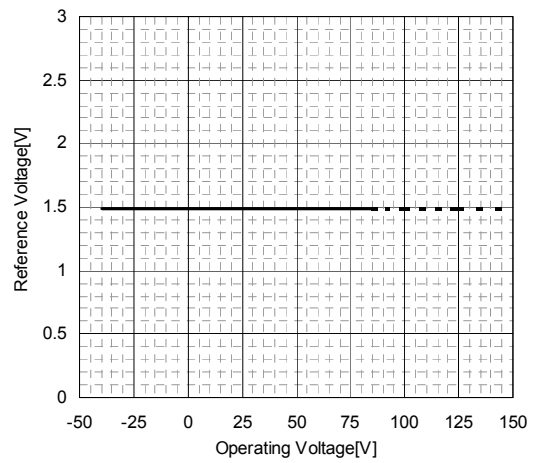

Supply Current vs. Supply Voltage  
RL=OPEN, Ta=25°C

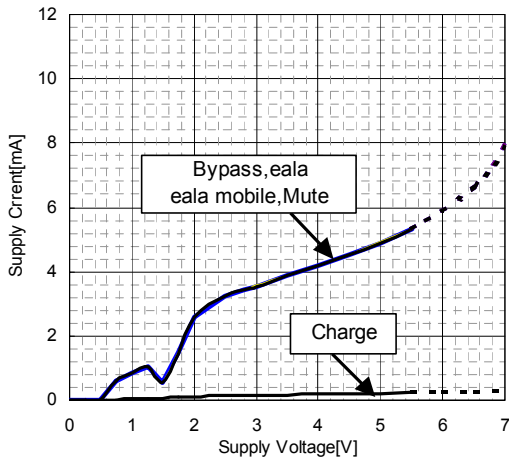

Supply Current vs. Ambient Temperature  
V+=3V, Gv=6dB, RL=OPEN

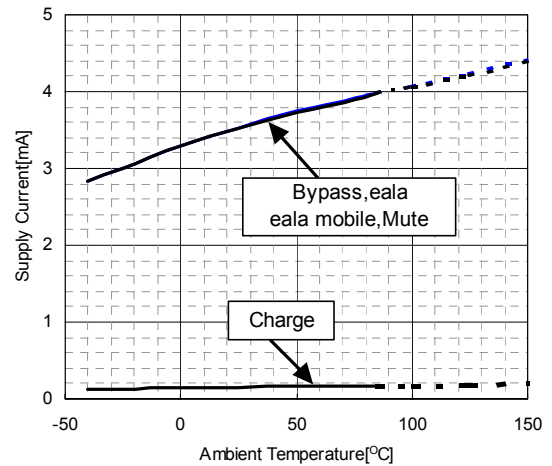

Supply Current vs. Supply Voltage  
(STBY mode)

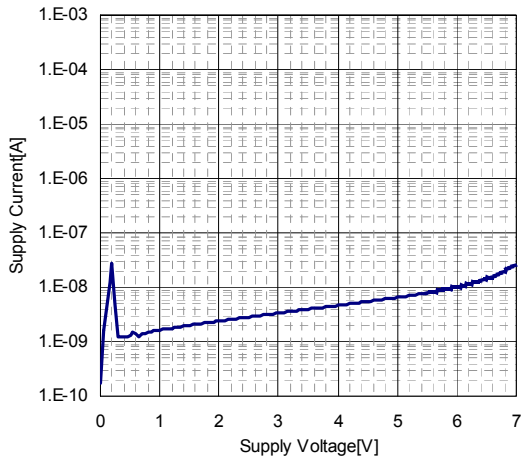

Supply Current vs. Ambient Temperature  
(Thermal shutdown)  
V+=3V, RL=OPEN

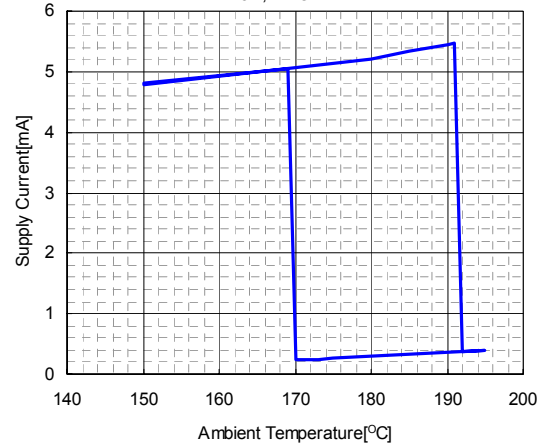

## TYPICAL CHARACTERISTICS

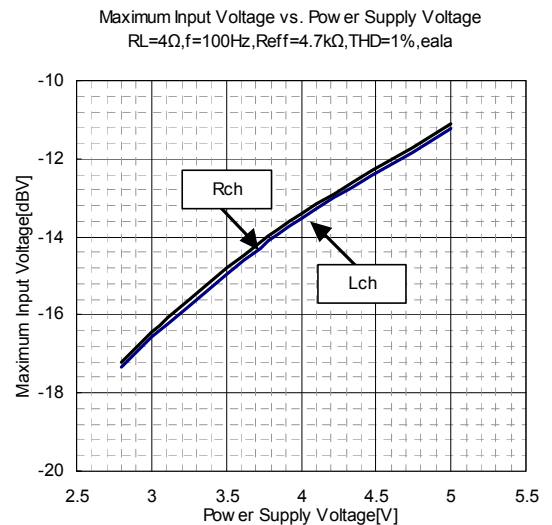
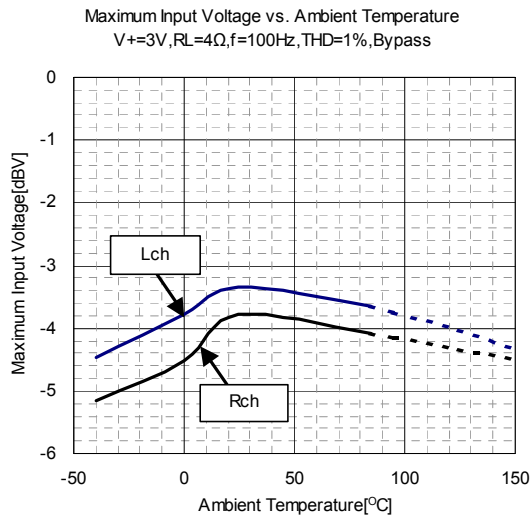
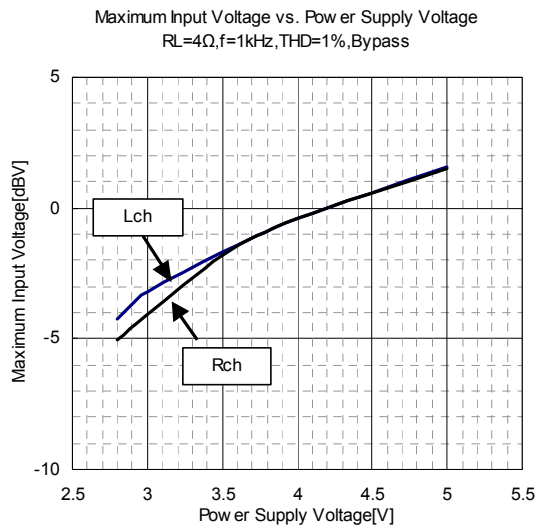
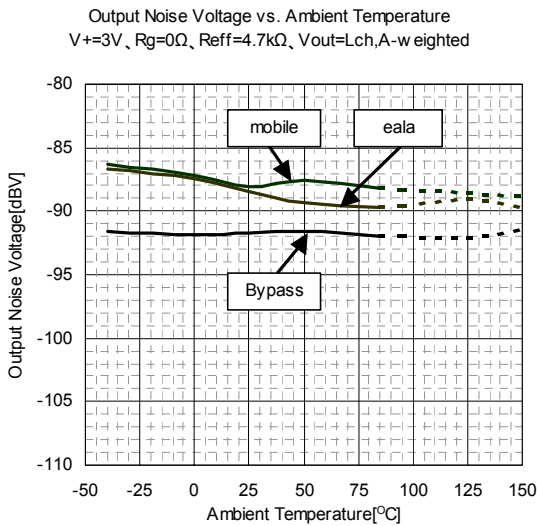
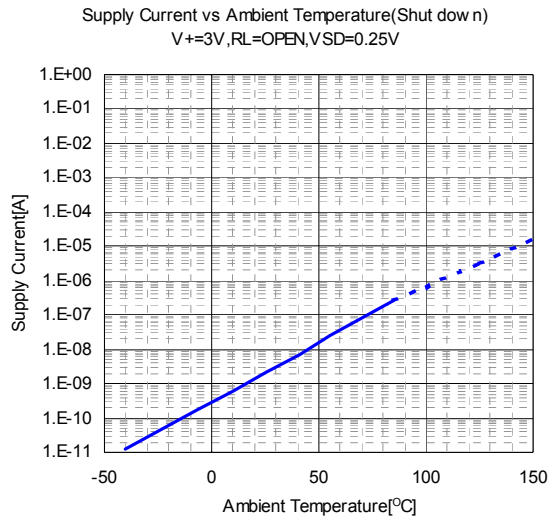
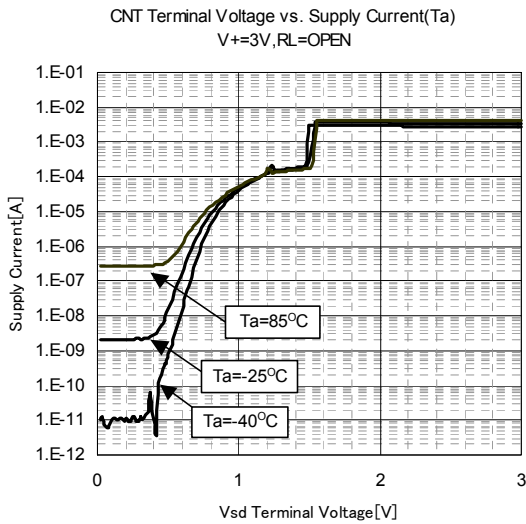

## TYPICAL CHARACTERISTICS

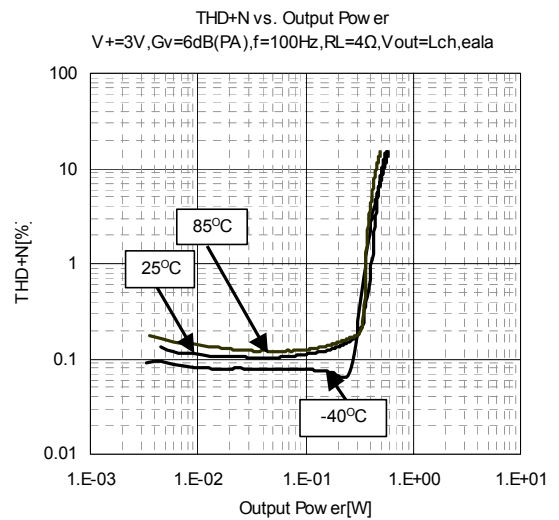
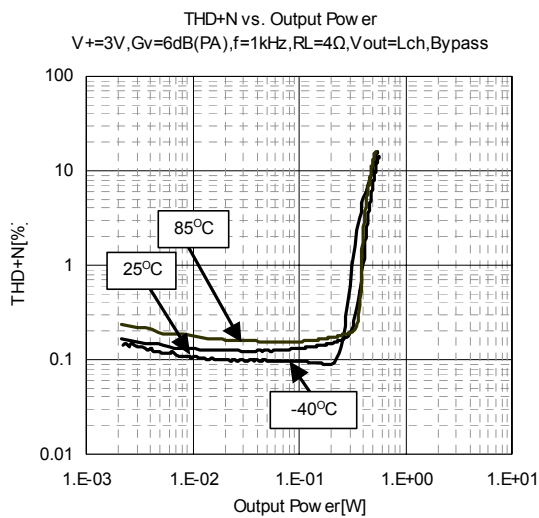
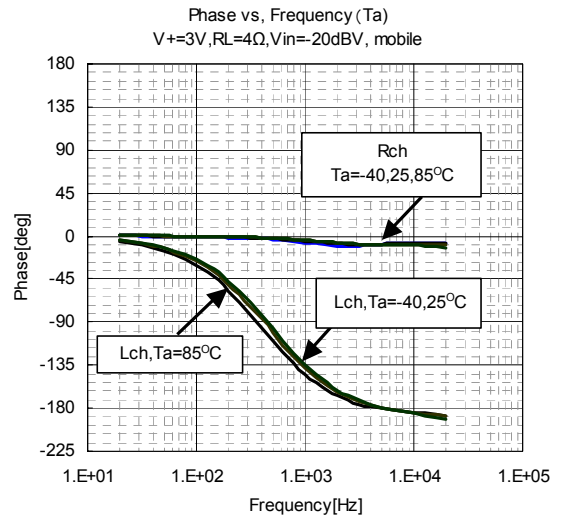
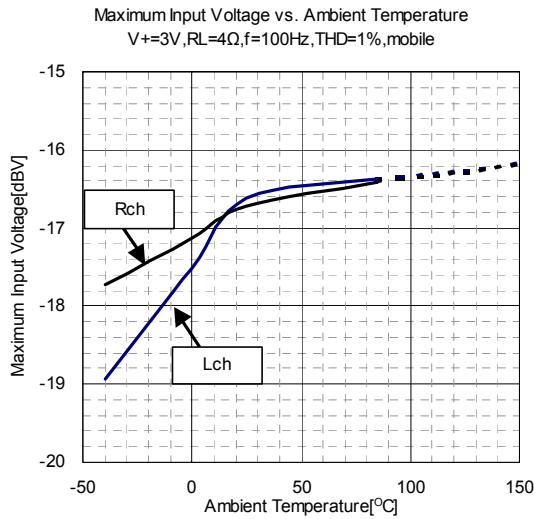
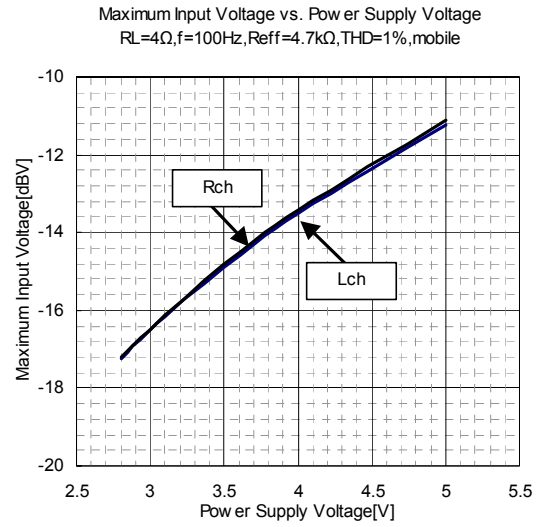
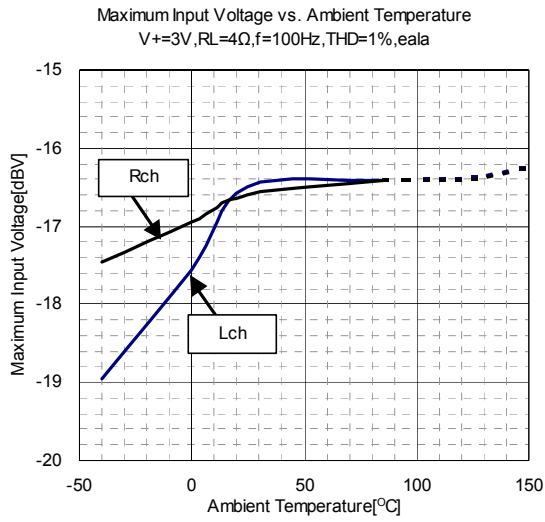

## TYPICAL CHARACTERISTICS

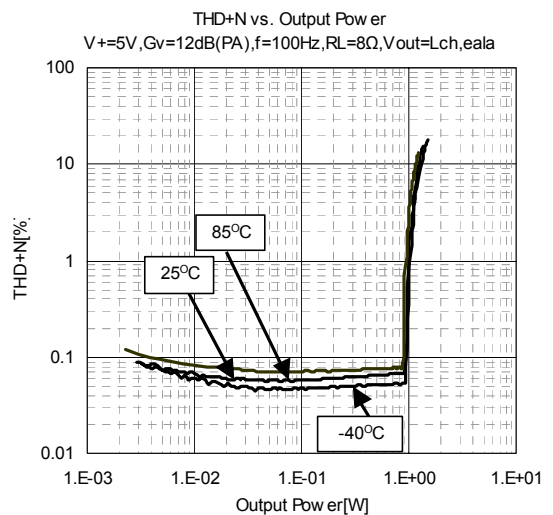
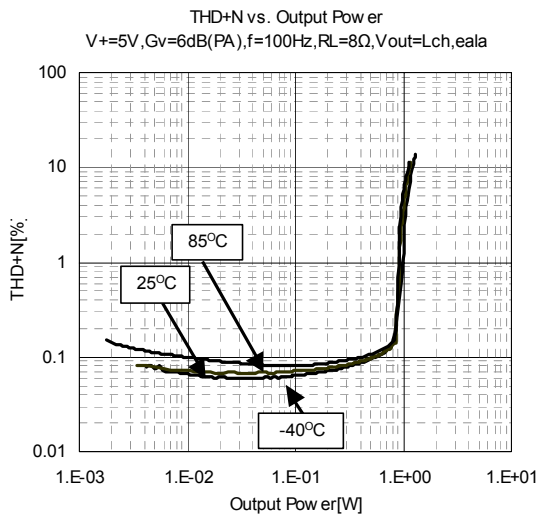
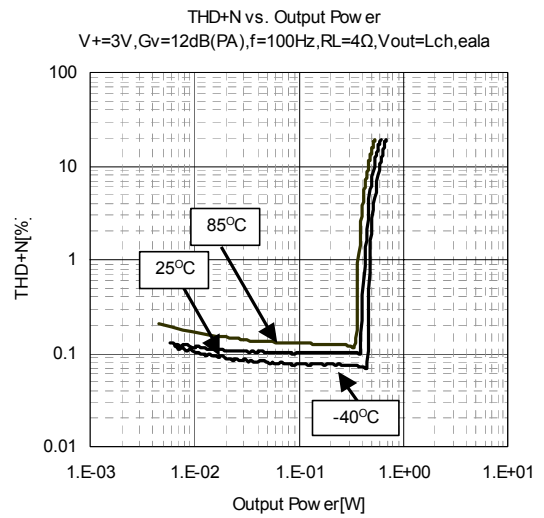
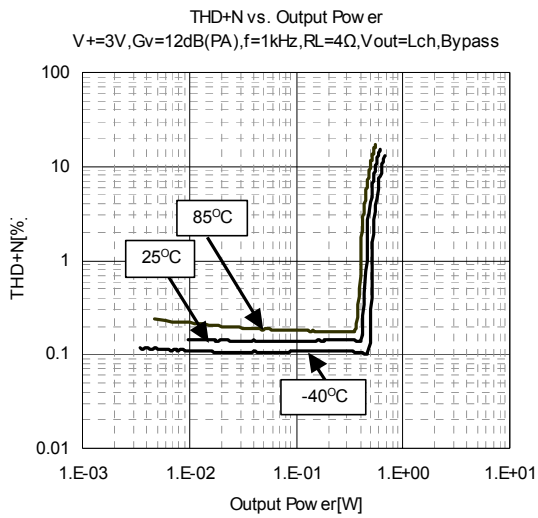
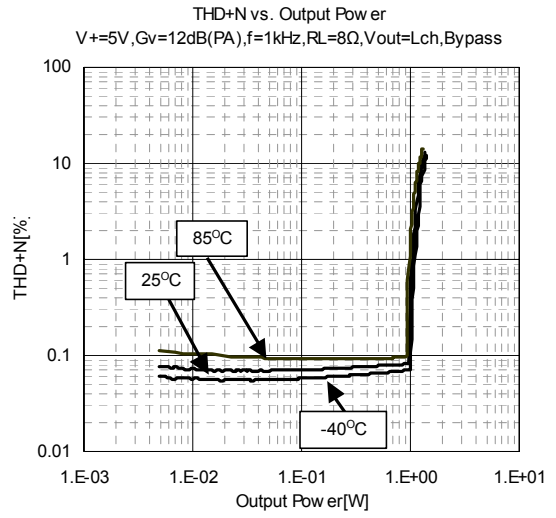
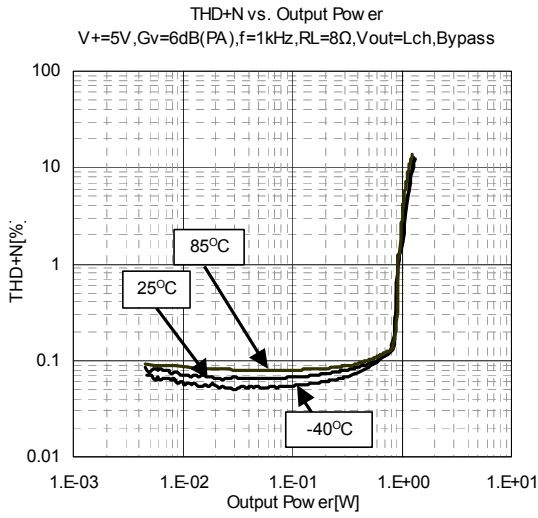



## TYPICAL CHARACTERISTICS

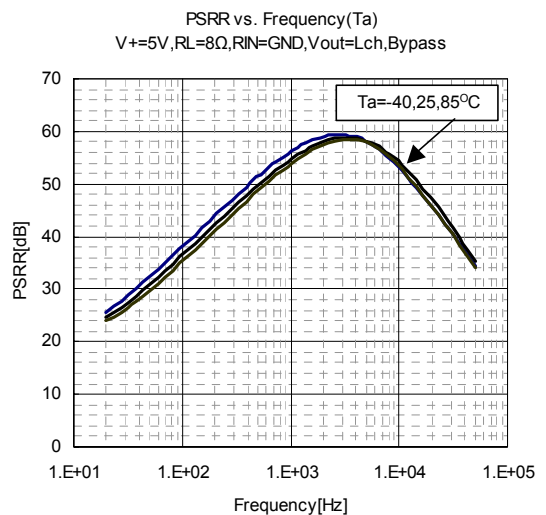
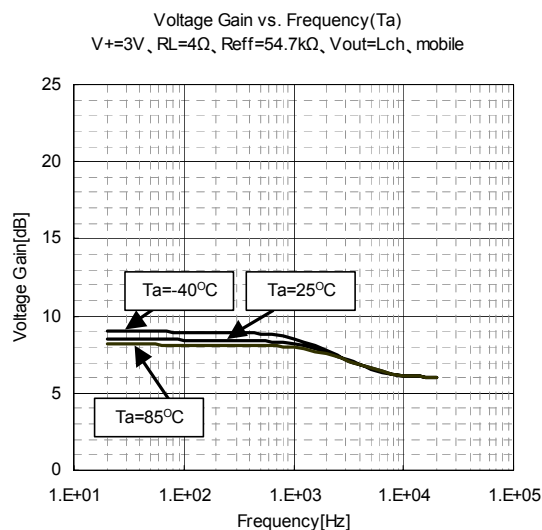
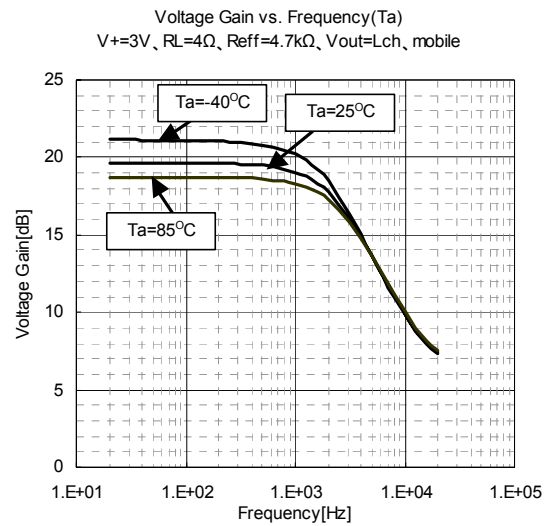
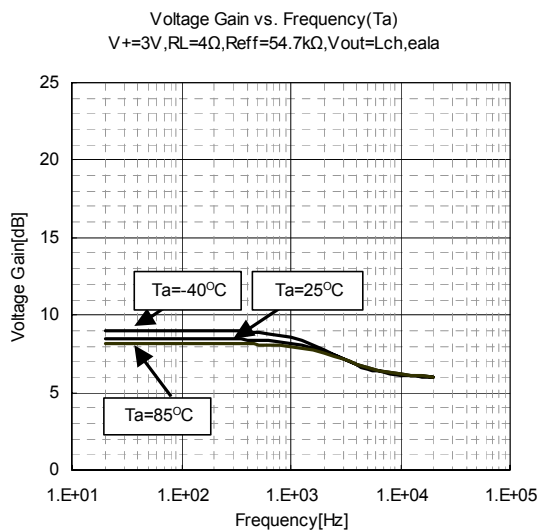
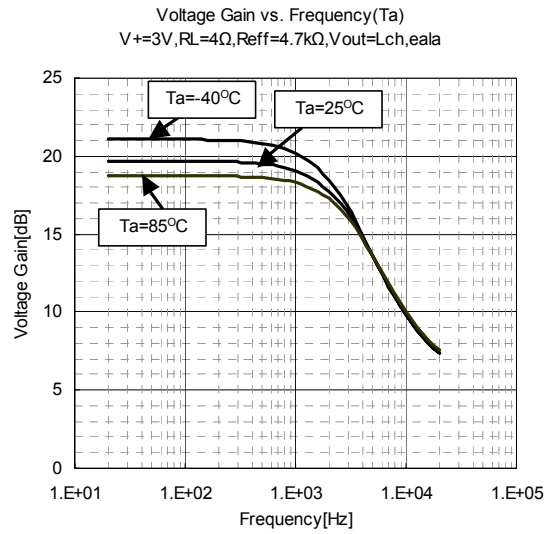
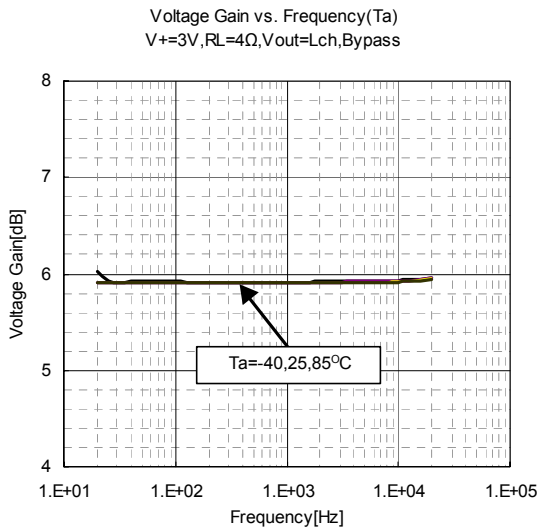

## TYPICAL CHARACTERISTICS

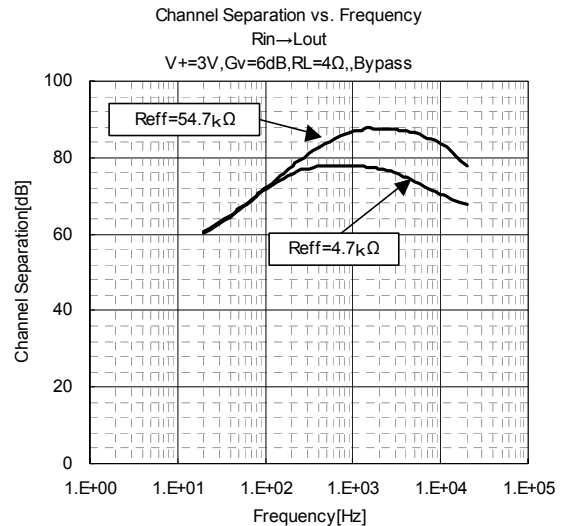
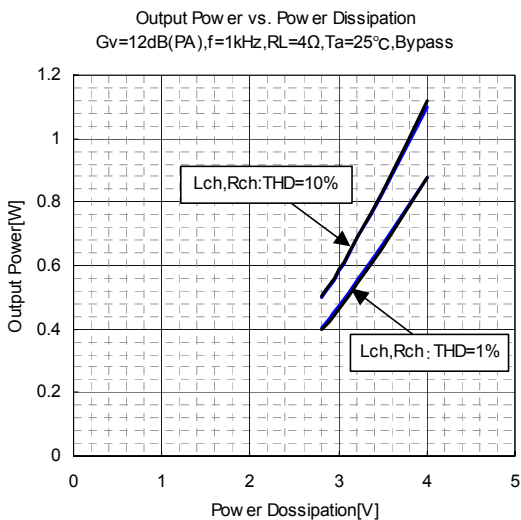
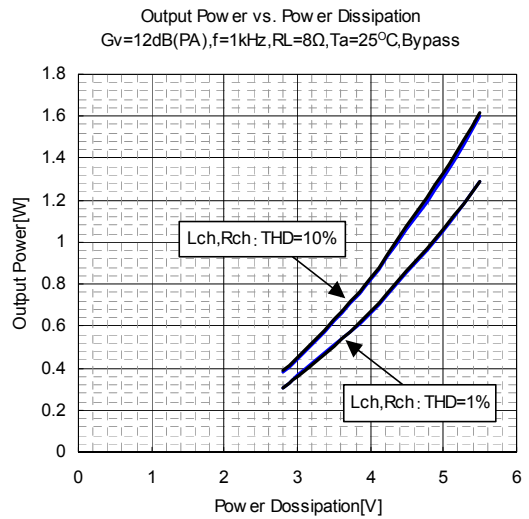
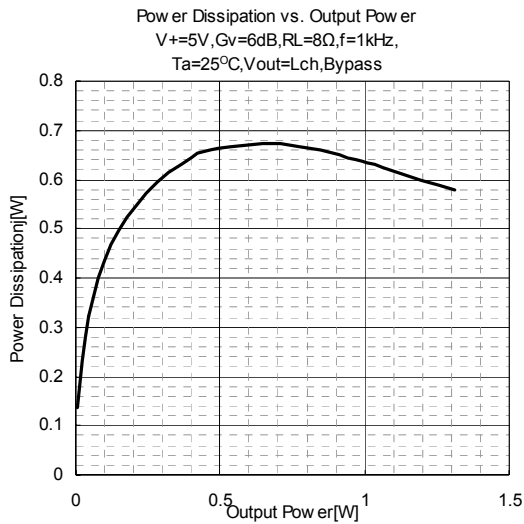
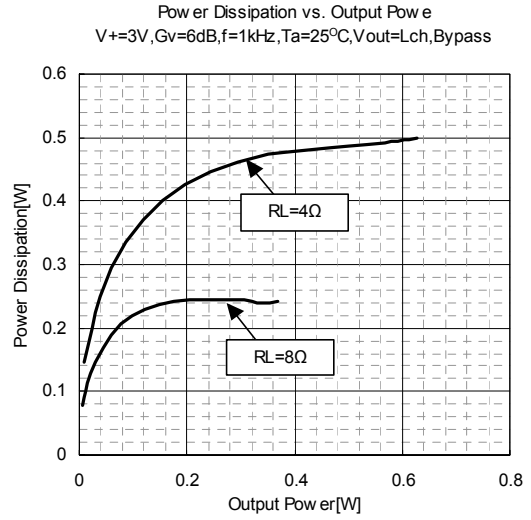
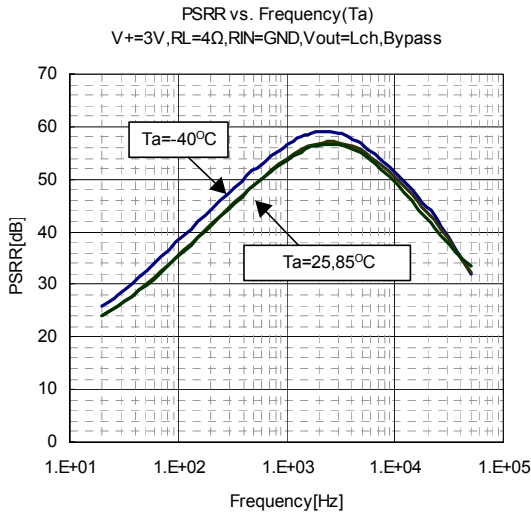

## ■ TYPICAL CHARACTERISTICS

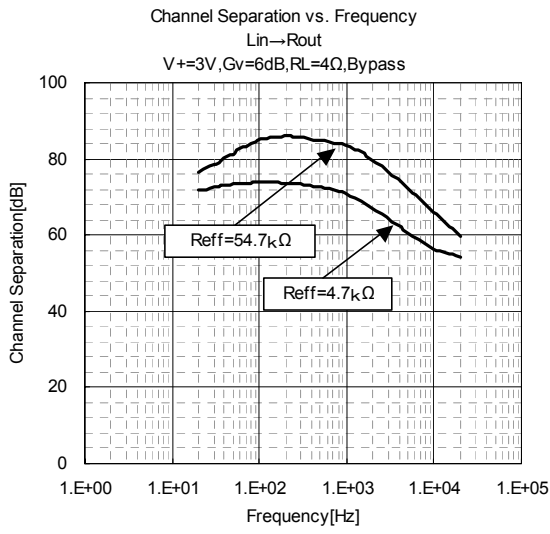

**[CAUTION]**

The specifications on this databook are only given for information, without any guarantee as regards either mistakes or omissions. The application circuits in this databook are described only to show representative usages of the product and not intended for the guarantee or permission of any right including the industrial rights.