

HiPerFAST™ IGBT

IXGH 32N60B
IXGT 32N60B
IXGH 32N60BD1
IXGT 32N60BD1

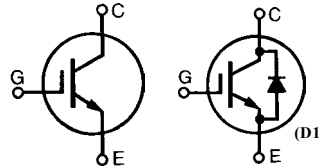

$V_{CES} = 600 \text{ V}$
 $I_{C25} = 60 \text{ A}$
 $V_{CE(sat)} = 2.3 \text{ V}$
 $t_{fi(typ)} = 85 \text{ ns}$

Symbol	Test Conditions	Maximum Ratings	
V_{CES}	$T_J = 25^\circ\text{C}$ to 150°C	600	V
V_{CGR}	$T_J = 25^\circ\text{C}$ to 150°C ; $R_{GE} = 1 \text{ M}\Omega$	600	V
V_{GES}	Continuous	± 20	V
V_{GEM}	Transient	± 30	V
I_{C25}	$T_C = 25^\circ\text{C}$	60	A
I_{C90}	$T_C = 90^\circ\text{C}$	32	A
I_{CM}	$T_C = 25^\circ\text{C}$, 1 ms	120	A
SSOA (RBSOA)	$V_{GE} = 15 \text{ V}$, $T_{VJ} = 125^\circ\text{C}$, $R_G = 22 \Omega$ Clamped inductive load	$I_{CM} = 64$ @ $0.8 V_{CES}$	A
P_C	$T_C = 25^\circ\text{C}$	200	W
T_J		-55 ... +150	$^\circ\text{C}$
T_{JM}		150	$^\circ\text{C}$
T_{stg}		-55 ... +150	$^\circ\text{C}$
M_d	Mounting torque (M3) TO-247AD	1.13/10	Nm/lb.in.
Maximum lead temperature for soldering 1.6 mm (0.062 in.) from case for 10 s		300	$^\circ\text{C}$
Weight	TO-247AD	6	g
	TO-268	4	g

TO-268 (IXGT)

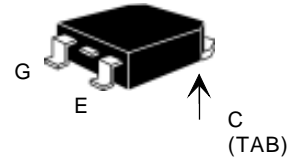

TO-247 AD (IXGH)

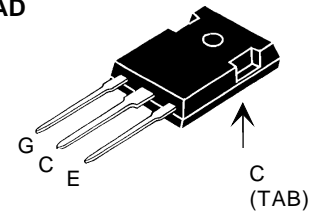

G = Gate,
E = Emitter,

C = Collector,
TAB = Collector

Features

- International standard packages
- High frequency IGBT and antiparallel FRED in one package
- High current handling capability
- HiPerFAST™ HDMOS™ process
- MOS Gate turn-on -drive simplicity

Applications

- Uninterruptible power supplies (UPS)
- Switched-mode and resonant-mode power supplies
- AC motor speed control
- DC servo and robot drives
- DC choppers

Advantages

- Space savings (two devices in one package)
- High power density
- Suitable for surface mounting
- Very low switching losses for high frequency applications
- Easy to mount with 1 screw, TO-247 (insulated mounting screw hole)

Symbol	Test Conditions	Characteristic Values ($T_J = 25^\circ\text{C}$, unless otherwise specified)		
		min.	typ.	max.
BV_{CES}	$I_C = 250 \mu\text{A}$, $V_{GE} = 0 \text{ V}$	600		V
$V_{GE(th)}$	$I_C = 250 \mu\text{A}$, $V_{CE} = V_{GE}$	2.5		5.0 V
I_{CES}	$V_{CE} = 0.8 \cdot V_{CES}$ $V_{GE} = 0 \text{ V}$	$T_J = 25^\circ\text{C}$		200 μA
		$T_J = 150^\circ\text{C}$		1 mA
		32N60B 32N60BD1		3 mA
I_{GES}	$V_{CE} = 0 \text{ V}$, $V_{GE} = \pm 20 \text{ V}$			$\pm 100 \text{ nA}$
$V_{CE(sat)}$	$I_C = I_{C90}$, $V_{GE} = 15 \text{ V}$			2.3 V

Symbol	Test Conditions	Characteristic Values		
		(T _J = 25°C, unless otherwise specified)		
		min.	typ.	max.
g_{fs}	I _C = I _{C90} ; V _{CE} = 10 V, Pulse test, t ≤ 300 μs, duty cycle ≤ 2 %	15	25	S
C_{ies}	V _{CE} = 25 V, V _{GE} = 0 V, f = 1 MHz		2700	pF
C_{oes}		32N60B	210	pF
		32N60BD1	240	pF
C_{res}			50	pF
Q_G	I _C = I _{C90} , V _{GE} = 15 V, V _{CE} = 0.5 V _{CES}		110	150 nC
Q_{GE}			23	35 nC
Q_{GC}			40	75 nC
t_{d(on)}	Inductive load, T_J = 25°C I _C = I _{C90} , V _{GE} = 15 V V _{CE} = 0.8 V _{CES} , R _G = R _{off} = 4.7 Ω Remarks: Switching times may increase for V _{CE} (Clamp) > 0.8 • V _{CES} , higher T _J or increased R _G		25	ns
t_{ri}			20	ns
t_{d(off)}			100	200 ns
t_{fi}			80	150 ns
E_{off}			0.6	1.2 mJ
t_{d(on)}	Inductive load, T_J = 125°C I _C = I _{C90} , V _{GE} = 15 V V _{CE} = 0.8 V _{CES} , R _G = R _{off} = 4.7 Ω Remarks: Switching times may increase for V _{CE} (Clamp) > 0.8 • V _{CES} , higher T _J or increased R _G		25	ns
t_{ri}			25	ns
E_{on}		32N60B	0.3	mJ
		32N60BD1	1.0	mJ
t_{d(off)}			120	ns
t_{fi}		120	ns	
E_{off}		1.2	mJ	
R_{thJC}				0.62 K/W
R_{thCK}	TO-247		0.25	K/W

Symbol	Test Conditions	Characteristic Values		
		(T _J = 25°C, unless otherwise specified)		
		min.	typ.	max.
V_F	I _F = I _{C90} , V _{GE} = 0 V, Pulse test, t ≤ 300 μs, duty cycle d ≤ 2 %			1.6 V 2.5 V
I_{RM}	I _F = I _{C90} , V _{GE} = 0 V, -di _F /dt = 100 A/μs V _R = 360 V I _F = 1 A; -di _F /dt = 100 A/μs; V _R = 30 V		6	A
t_{rr}		T _J = 125°C	100	ns
		T _J = 25°C	25	ns
R_{thJC}				1.0 K/W

TO-247 AD (IXGH) Outline

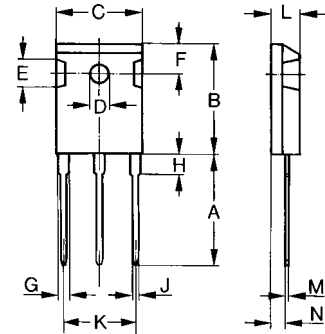

Dim.	Millimeter		Inches	
	Min.	Max.	Min.	Max.
A	19.81	20.32	0.780	0.800
B	20.80	21.46	0.819	0.845
C	15.75	16.26	0.610	0.640
D	3.55	3.65	0.140	0.144
E	4.32	5.49	0.170	0.216
F	5.4	6.2	0.212	0.244
G	1.65	2.13	0.065	0.084
H	-	4.5	-	0.177
J	1.0	1.4	0.040	0.055
K	10.8	11.0	0.426	0.433
L	4.7	5.3	0.185	0.209
M	0.4	0.8	0.016	0.031
N	1.5	2.49	0.087	0.102

TO-268AA (D³ PAK)

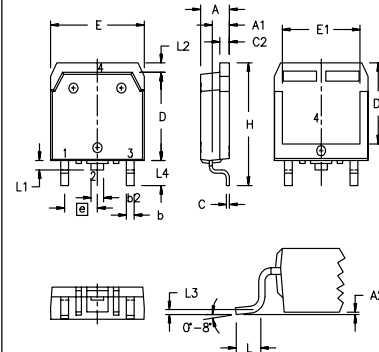

Dim.	Millimeter		Inches	
	Min.	Max.	Min.	Max.
A	4.9	5.1	.193	.201
A ₁	2.7	2.9	.106	.114
A ₂	.02	.25	.001	.010
b	1.15	1.45	.045	.057
b ₂	1.9	2.1	.75	.83
C	.4	.65	.016	.026
D	13.80	14.00	.543	.551
E	15.85	16.05	.624	.632
E ₁	13.3	13.6	.524	.535
e	5.45 BSC		.215 BSC	
H	18.70	19.10	.736	.752
L	2.40	2.70	.094	.106
L1	1.20	1.40	.047	.055
L2	1.00	1.15	.039	.045
L3	0.25 BSC		.010 BSC	
L4	3.80	4.10	.150	.161

IXYS reserves the right to change limits, test conditions, and dimensions.

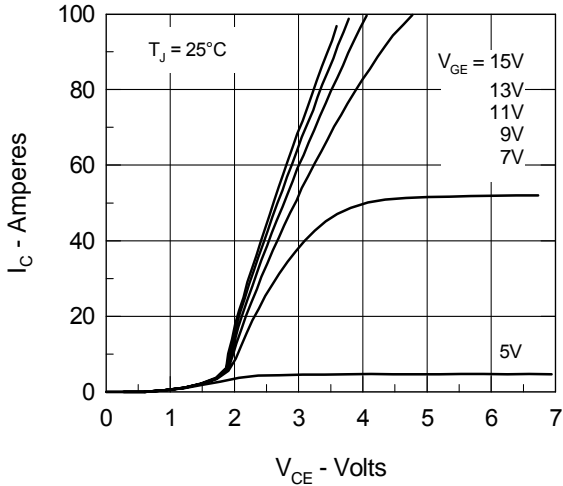

Fig. 1. Saturation Voltage Characteristics

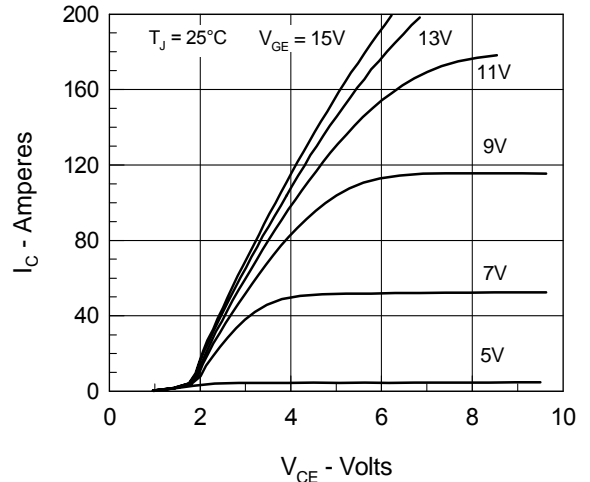

Fig. 2. Extended Output Characteristics

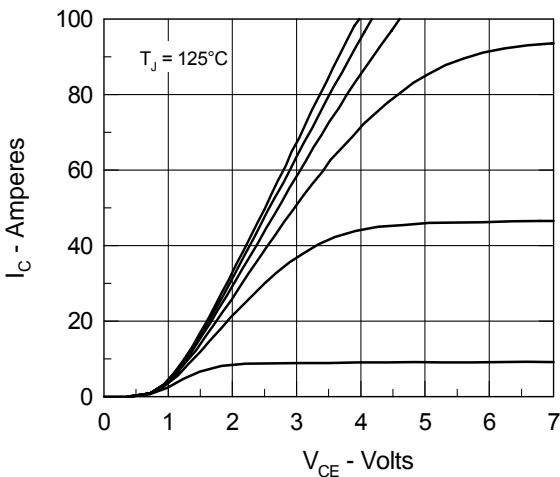

Fig. 3. Saturation Voltage Characteristics

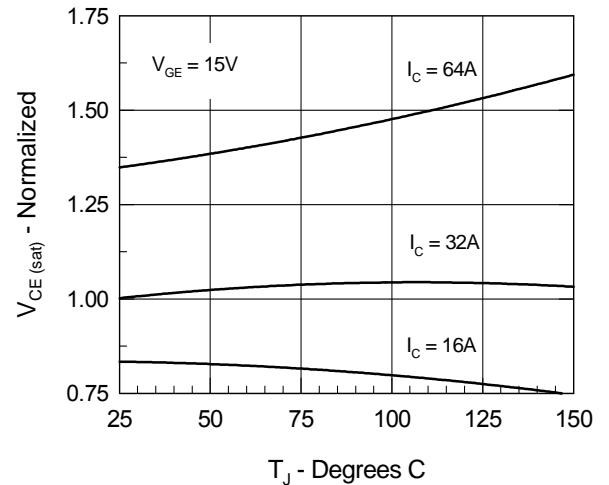

Fig. 4. Temperature Dependence of $V_{CE(sat)}$

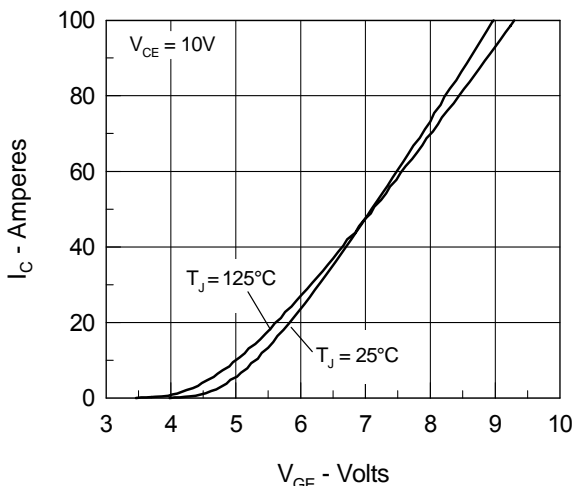

Fig. 5. Admittance Curves

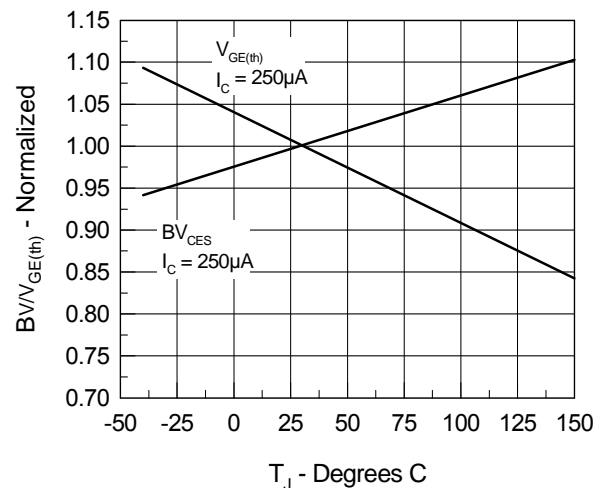

Fig. 6. Temperature Dependence of BV_{DSS} & $V_{GE(th)}$

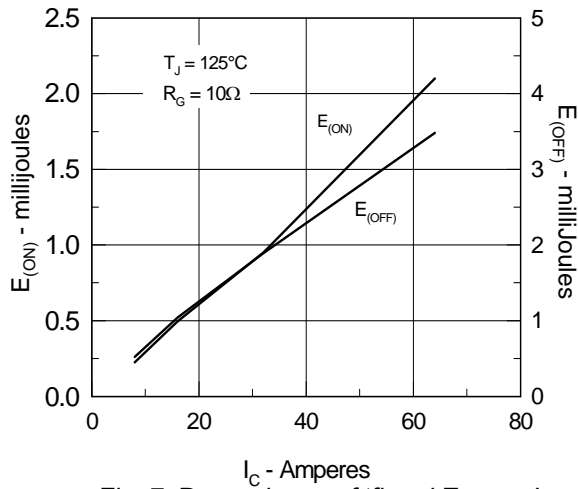

Fig. 7. Dependence of t_{fi} and E_{OFF} on I_C .

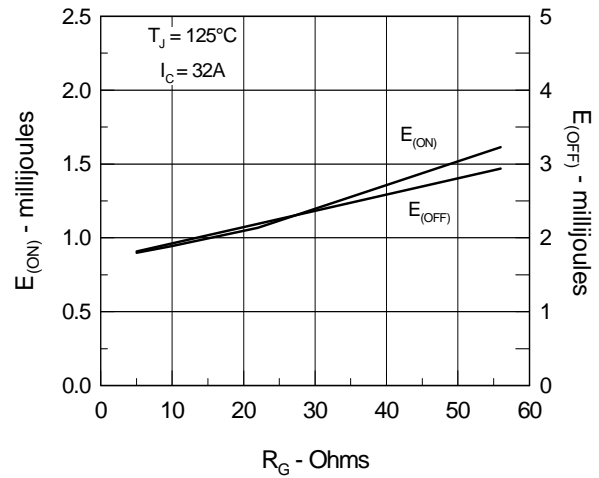

Fig. 8. Dependence of t_{fi} and E_{OFF} on R_G .

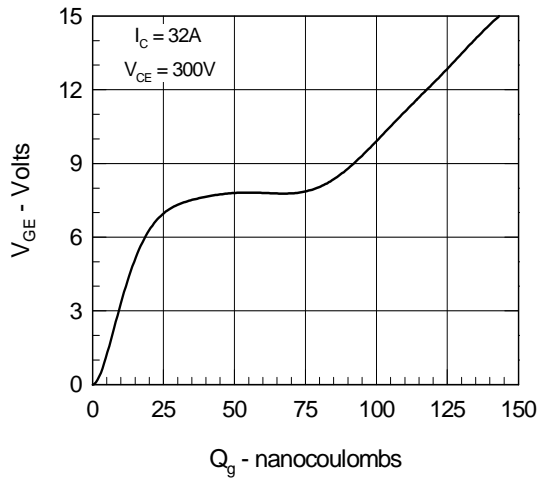

Fig. 9. Gate Charge

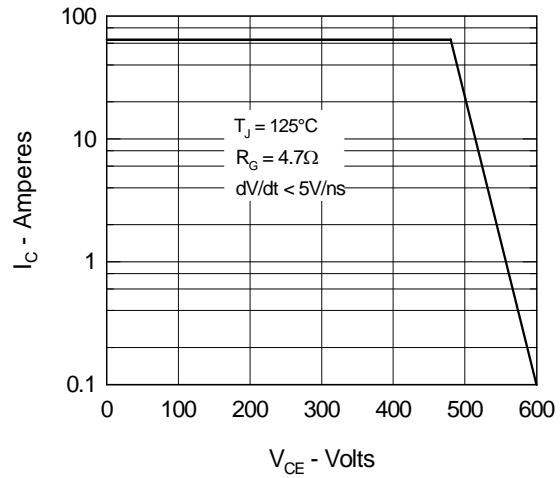

Fig. 10. Turn-off Safe Operating Area

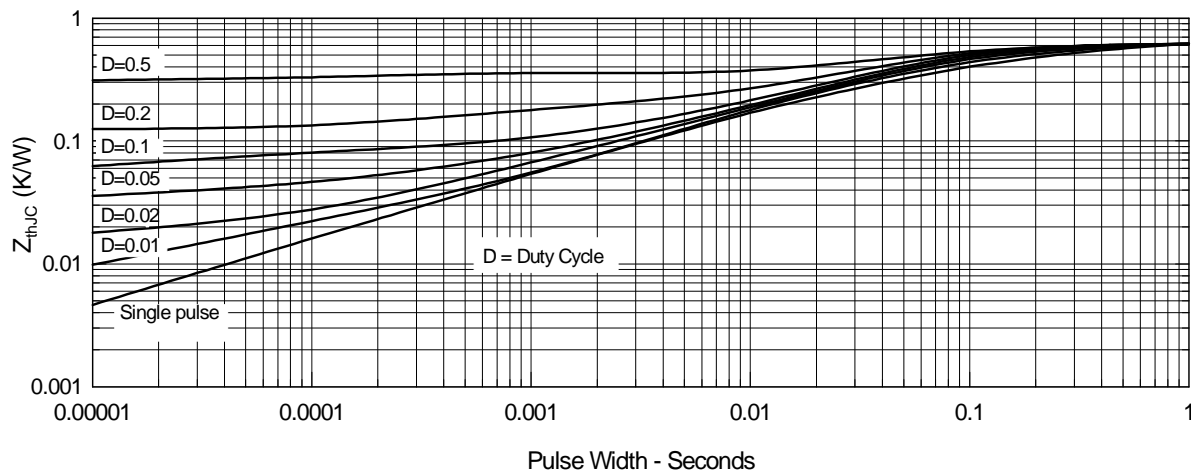

Fig. 11. Transient Thermal Resistance

IXYS reserves the right to change limits, test conditions, and dimensions.

IXYS MOSFETS and IGBTs are covered by one or more of the following U.S. patents:

4,835,592	4,881,106	5,017,508	5,049,961	5,187,117	5,486,715	6,306,728B1
4,850,072	4,931,844	5,034,796	5,063,307	5,237,481	5,381,025	

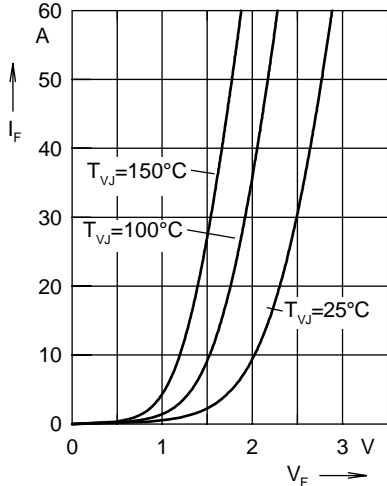

Fig. 12 Forward current I_F versus V_F

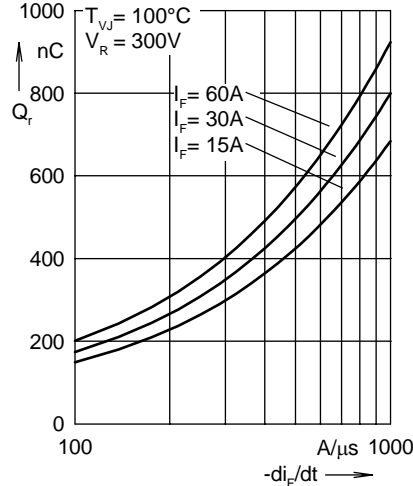

Fig. 13 Reverse recovery charge Q_r versus $-di_F/dt$

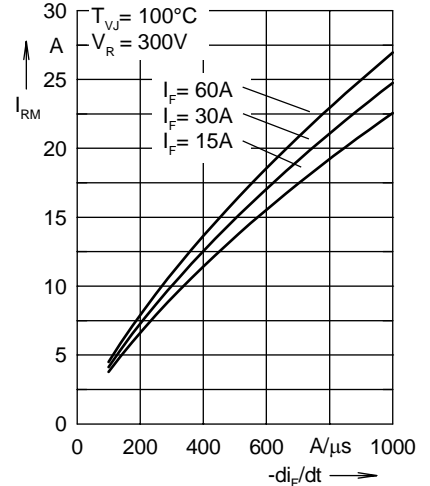

Fig. 14 Peak reverse current I_{RM} versus $-di_F/dt$

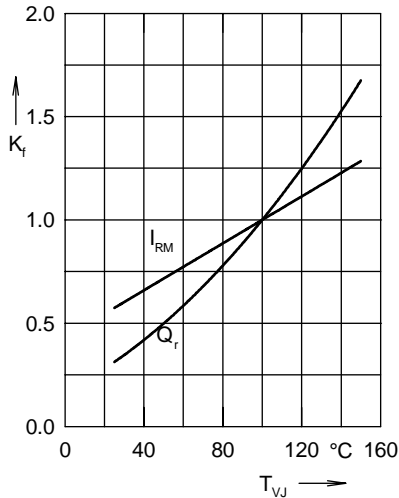

Fig. 15 Dynamic parameters Q_r , I_{RM} versus T_{VJ}

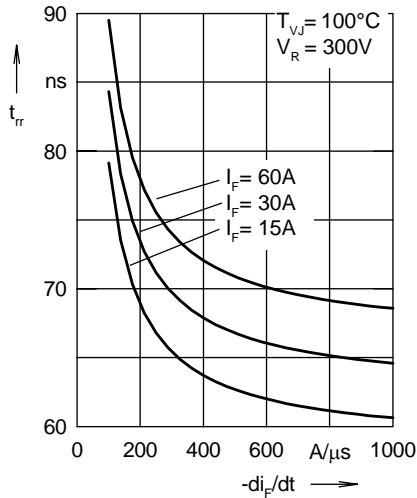

Fig. 16 Recovery time t_{rr} versus $-di_F/dt$

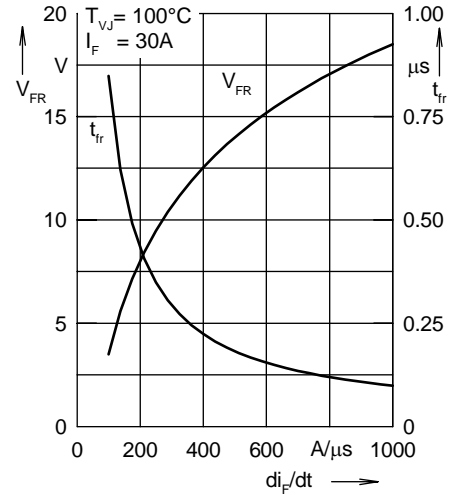

Fig. 17 Peak forward voltage V_{FR} and t_{rr} versus di_F/dt

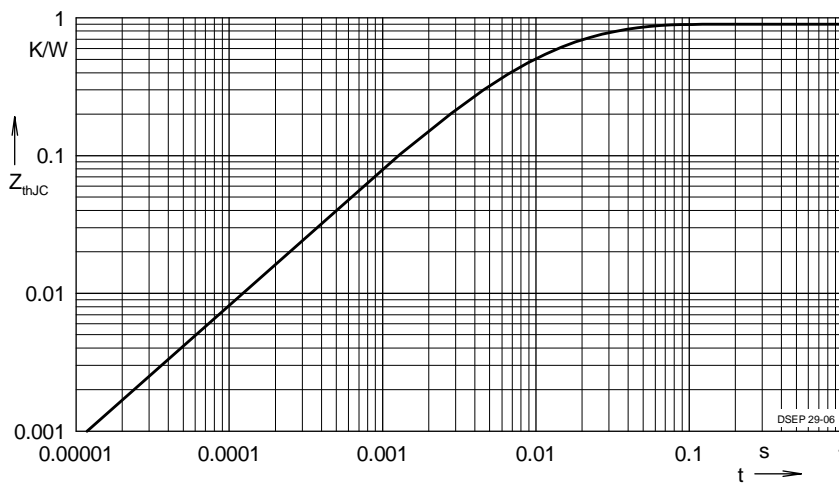

Fig. 18 Transient thermal resistance junction to case

Constants for Z_{thJC} calculation:

i	R_{thi} (K/W)	t_i (s)
1	0.502	0.0052
2	0.193	0.0003
3	0.205	0.0162