

# 10. Schematic Diagrams

## 10-1 MAIN(1/3)

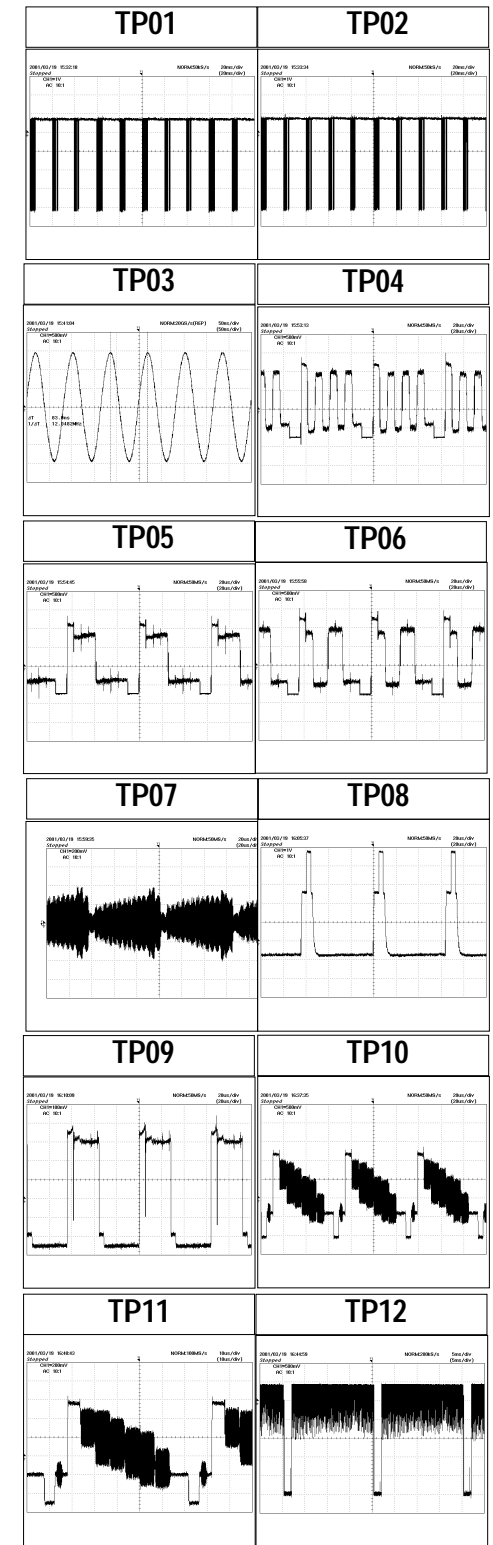

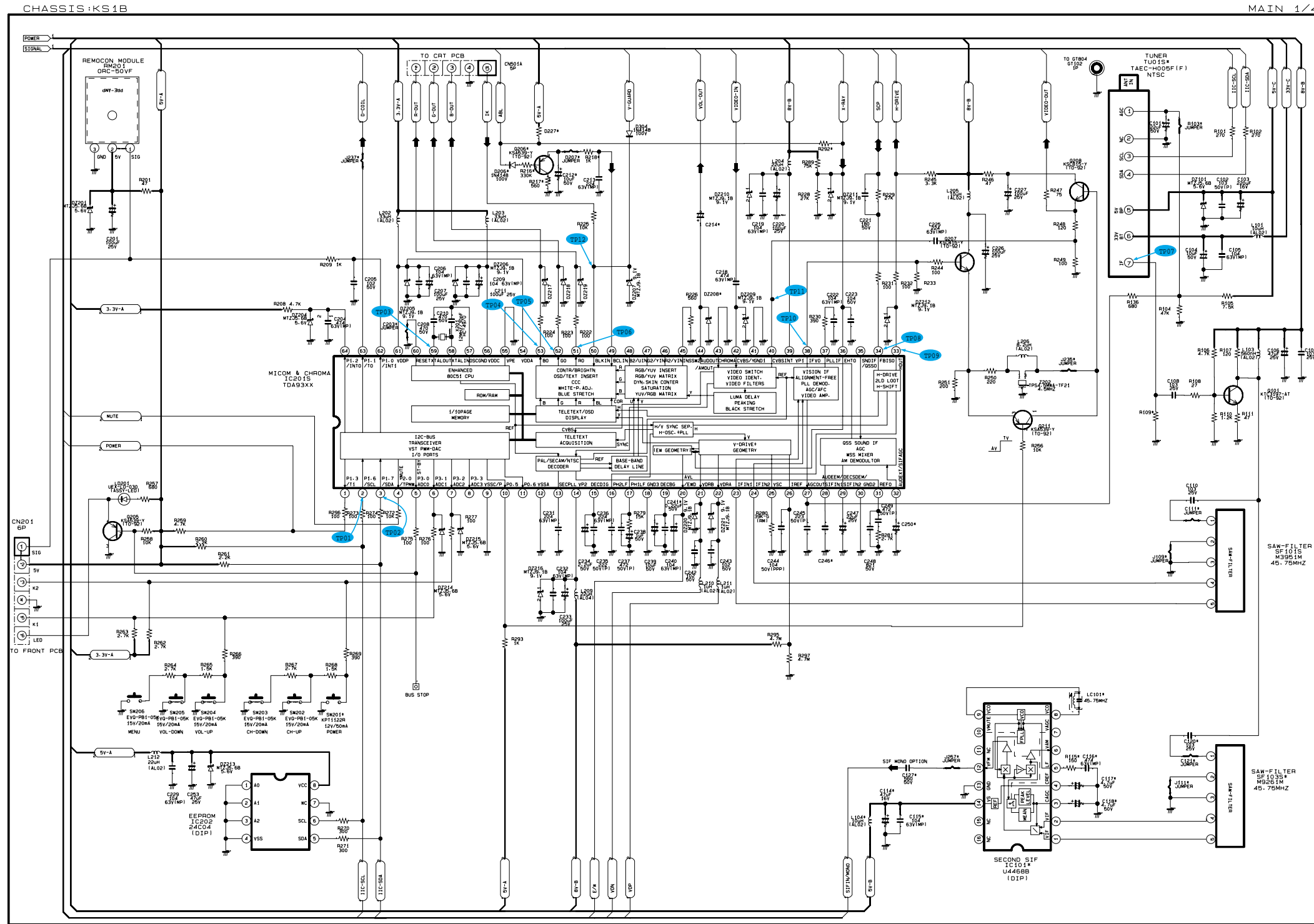

10-3 MAIN(3/3)

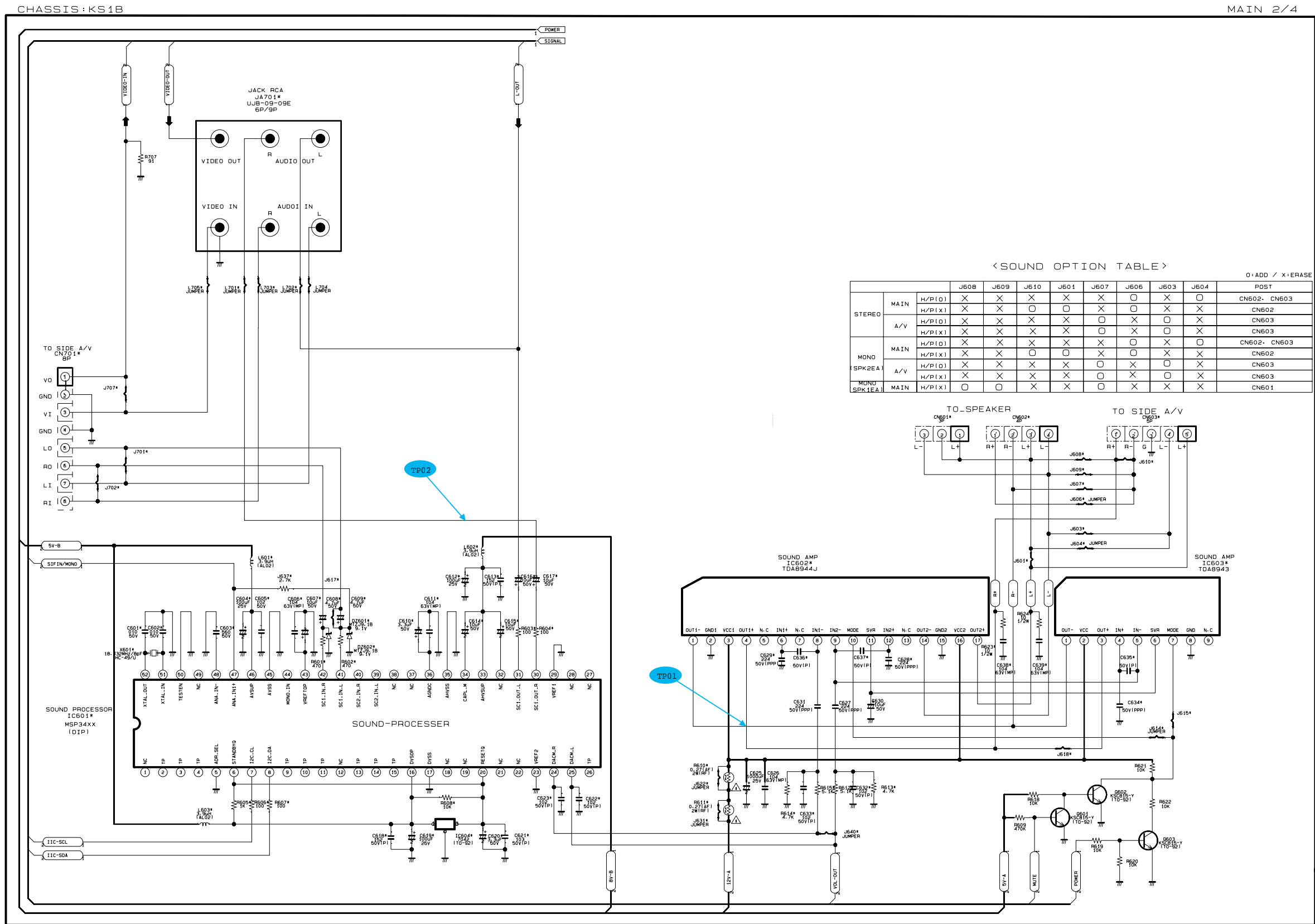

<SOUND OPTION TABLE>

										O: ADD / X: ERASE
										POST
STEREO	MAIN	H/P(O)	X	X	X	X	X	X	X	CN602- CN603
	H/P(X)	X	X	X	X	X	X	X	X	CN602
A/V	H/P(O)	X	X	X	X	X	X	X	X	CN603
	H/P(X)	X	X	X	X	X	X	X	X	CN603
MONO	MAIN	H/P(O)	X	X	X	X	X	X	X	CN602- CN603
	H/P(X)	X	X	X	X	X	X	X	X	CN602
SPK2EA	H/P(O)	X	X	X	X	X	X	X	X	CN603
	H/P(X)	X	X	X	X	X	X	X	X	CN603
MONO	MAIN	H/P(X)	O	O	X	X	O	X	X	CN601

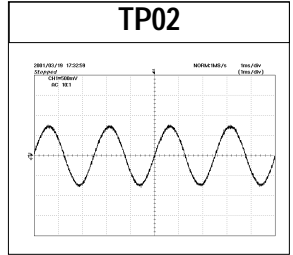
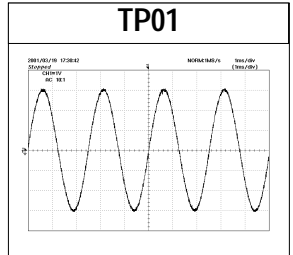

Power Line  
Signal Line

10-4 CRT, SIDE A/V

CHASSIS : KS1B

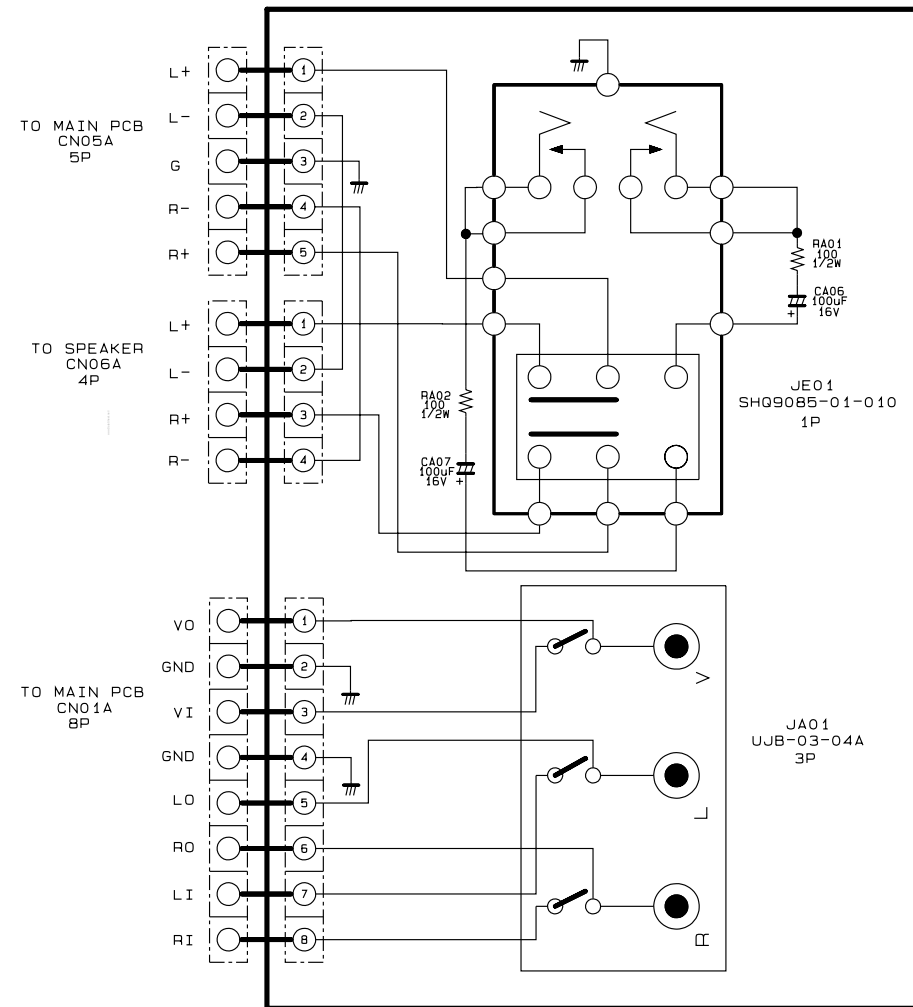
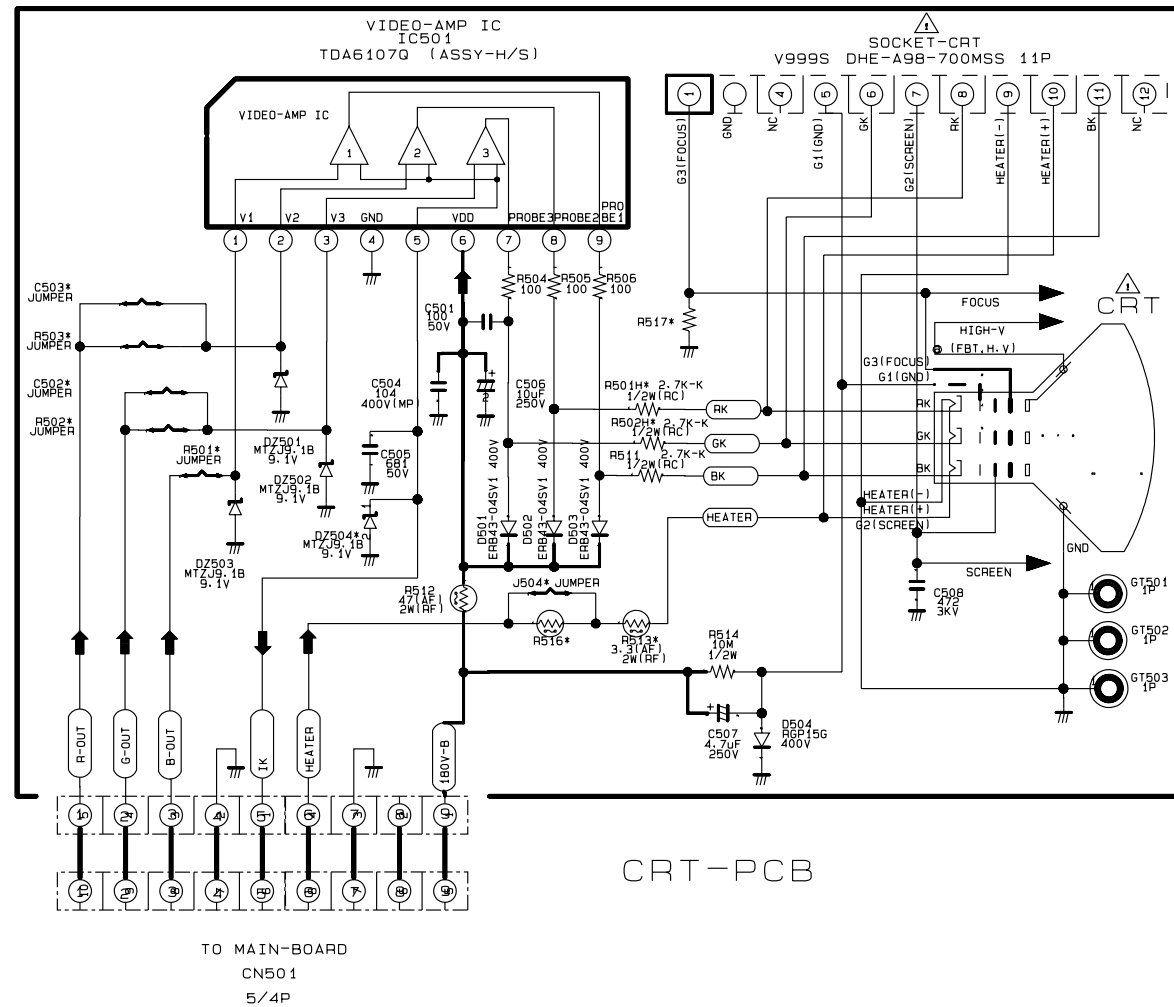

<SIDE A/V OPTION>

ASSY CODE	REMARK
AA95-00738A	21K3W