



# BAT54AW

DIODE

## SCHOTTKY BARRIER (DUAL) DIODES

### DESCRIPTION

Planar Schottky barrier diodes are encapsulated in the SOT-323 small plastic SMD package. Single diodes and dual diodes with different pin configuration are available.

### FEATURES

- \* Low forward voltage
- \* Guard ring protected
- \* Small plastic SMD package

### SYMBOL

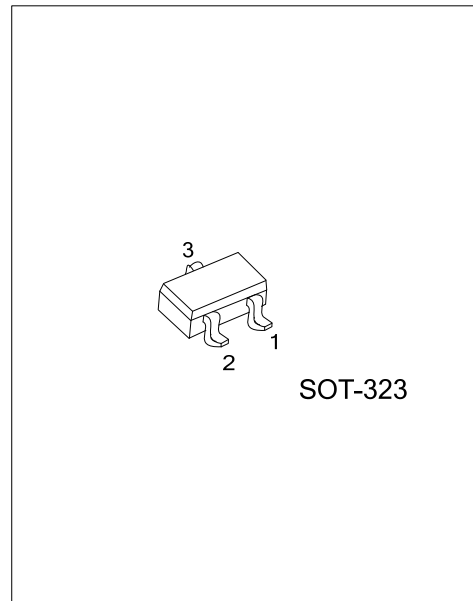
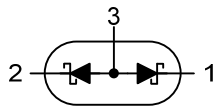

### ORDERING INFORMATION

Ordering Number		Package	Pin Assignment			Packing
Lead Free	Halogen Free		1	2	3	
BAT54AWL-AL3-R	BAT54AWG-AL3-R	SOT-323	K1	K2	A2A1	Tape Reel

Note: Pin Assignment: A: Anode K: Cathode

<p>BAT54AWL-AE3-R</p> <ul style="list-style-type: none"> <li>(1)Packing Type</li> <li>(2)Package Type</li> <li>(3)Lead Free</li> </ul>	<ul style="list-style-type: none"> <li>(1) R: Tape Reel</li> <li>(2) AL3: SOT-323</li> <li>(3) G: Halogen Free, L: Lead Free</li> </ul>
--	---

### MARKING

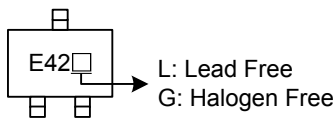

### ■ ABSOLUTE MAXIMUM RATINGS

PARAMETER	SYMBOL	RATINGS	UNIT
<b>PER DIODE</b>			
Continuous Reverse Voltage	$V_R$	30	V
Continuous Forward Current	$I_F$	200	mA
Repetitive Peak Forward Current ( $t_P < 1s, \delta \leq 0.5$ )	$I_{FRM}$	300	mA
Non-repetitive Peak Forward Current ( $t_P < 10ms$ )	$I_{FSM}$	600	mA
Junction Temperature	$T_J$	+125	°C
Storage Temperature	$T_{STG}$	-60 ~ +150	°C
<b>PER DEVICE</b>			
Power Dissipation ( $T_A \leq 25^\circ C$ )	$P_D$	230	mW

Note: Absolute maximum ratings are those values beyond which the device could be permanently damaged. Absolute maximum ratings are stress ratings only and functional device operation is not implied.

### ■ THERMAL DATA

PARAMETER	SYMBOL	RATINGS	UNIT
Junction to Ambient	$\theta_{JA}$	625	°C/W

### ■ ELECTRICAL CHARACTERISTICS ( $T_A = 25^\circ C$ , unless otherwise specified.)

PARAMETER	SYMBOL	TEST CONDITIONS	MIN	TYP	MAX	UNIT
Forward Voltage (See Fig.1)	$V_F$	$I_F = 0.1mA$			240	mV
		$I_F = 1mA$			320	mV
		$I_F = 10mA$			400	mV
		$I_F = 30mA$			500	mV
		$I_F = 100mA$			800	mV
Reverse Current (See Fig.2)	$I_R$	$V_R = 25V$			2	$\mu A$
Reverse Recovery Time (see Fig.4)	$t_{rr}$	When switched from $I_F = 10mA$ to $I_R = 10mA, R_L = 100\Omega$ measured at $I_R = 1mA$			5	ns
Diode Capacitance (see Fig.3)	$C_D$	$f = 1 MHz, V_R = 1V;$			10	pF

## TYPICAL CHARACTERISTICS

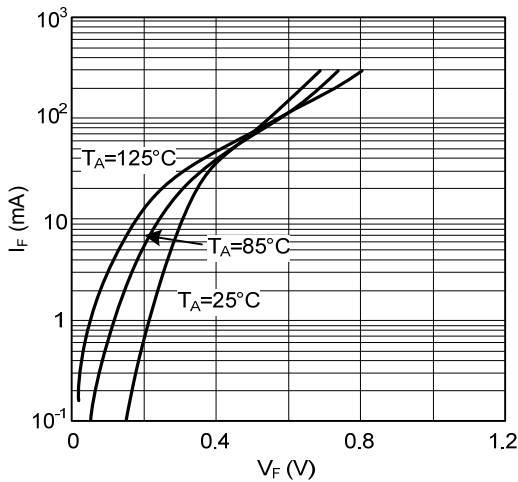

Fig.1 Forward current as a function of forward voltage; typical values.

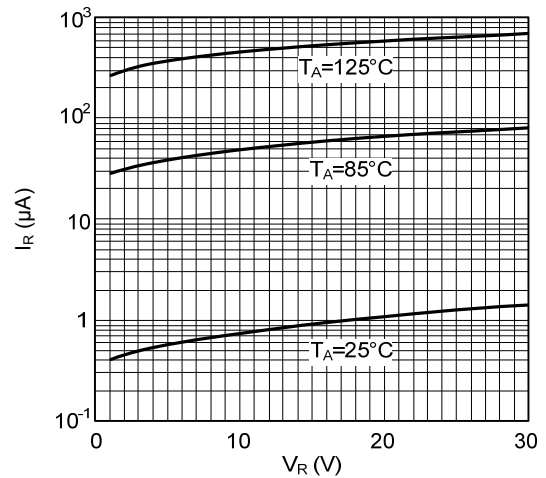

Fig.2 Reverse current as a function of reverse voltage; typical values.

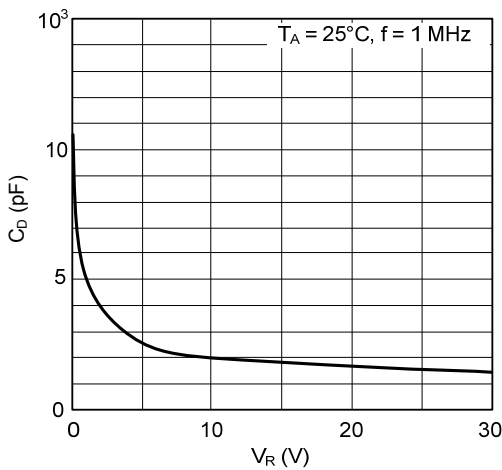

Fig.3 Diode capacitance as a function of reverse voltage; typical values.

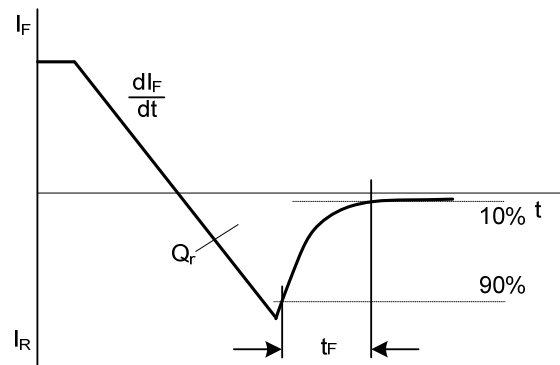

Fig.4 Reverse recovery definitions

UTC assumes no responsibility for equipment failures that result from using products at values that exceed, even momentarily, rated values (such as maximum ratings, operating condition ranges, or other parameters) listed in products specifications of any and all UTC products described or contained herein. UTC products are not designed for use in life support appliances, devices or systems where malfunction of these products can be reasonably expected to result in personal injury. Reproduction in whole or in part is prohibited without the prior written consent of the copyright owner. The information presented in this document does not form part of any quotation or contract, is believed to be accurate and reliable and may be changed without notice.