

# Automotive Temperature Range Spread-Spectrum Econoscillator

## General Description

The DS1091L is a low-cost clock generator that is factory-trimmed to output frequencies from 130kHz to 66.6MHz with a nominal accuracy of  $\pm 0.25\%$ . The device can also produce a center- or down-dithered spread-spectrum output with pin-selectable dither magnitude and rate. Assembled in an 8-pin  $\mu\text{MAX}^{\text{®}}$  package, the DS1091L is designed to operate with a 3.0V to 3.6V power supply over the automotive temperature range ( $-40^{\circ}\text{C}$  to  $+125^{\circ}\text{C}$ ).

## Applications

Automotive Infotainment  
POS Terminals  
LCD Displays  
Printers  
Industrial Control

## Features

- ◆ Spread-Spectrum Clock Output from 130kHz to 66.6MHz
- ◆ Operating Temperature Range of  $-40^{\circ}\text{C}$  to  $+125^{\circ}\text{C}$
- ◆ Accuracy of  $\pm 1.75\%$  Across Temperature and Voltage
- ◆ Factory Trimmed
- ◆ Center-Dithered (DS1091LA) or Down-Dithered (DS1091LB) Spread-Spectrum Output
- ◆ Pin-Selectable Center-Dither Magnitude of 0%,  $\pm 1\%$ ,  $\pm 2\%$ , or  $\pm 4\%$
- ◆ Pin-Selectable Down-Dither Magnitude of 0%,  $-2\%$ ,  $-4\%$ , or  $-8\%$
- ◆ Pin-Selectable Dither Rate
- ◆ 3.0V to 3.6V Supply Operation
- ◆ Lead-Free 8-Pin  $\mu\text{MAX}$  Package

## Ordering Information

PART	TEMP RANGE	PIN-PACKAGE	SPREAD SPECTRUM	OUTPUT FREQUENCY (MHz)
DS1091LUA-027+	$-40^{\circ}\text{C}$ to $+125^{\circ}\text{C}$	8 $\mu\text{MAX}$	Center	27.0
DS1091LUA-033+	$-40^{\circ}\text{C}$ to $+125^{\circ}\text{C}$	8 $\mu\text{MAX}$	Center	33.3
DS1091LUA-066+	$-40^{\circ}\text{C}$ to $+125^{\circ}\text{C}$	8 $\mu\text{MAX}$	Center	66.6
DS1091LUA-xxx+	$-40^{\circ}\text{C}$ to $+125^{\circ}\text{C}$	8 $\mu\text{MAX}$	Center	Custom (Contact Factory)
DS1091LUB-027+	$-40^{\circ}\text{C}$ to $+125^{\circ}\text{C}$	8 $\mu\text{MAX}$	Down	27.0
DS1091LUB-033+	$-40^{\circ}\text{C}$ to $+125^{\circ}\text{C}$	8 $\mu\text{MAX}$	Down	33.3
DS1091LUB-066+	$-40^{\circ}\text{C}$ to $+125^{\circ}\text{C}$	8 $\mu\text{MAX}$	Down	66.6
DS1091LUB-xxx+	$-40^{\circ}\text{C}$ to $+125^{\circ}\text{C}$	8 $\mu\text{MAX}$	Down	Custom (Contact Factory)

+Denotes lead-free package.

xxx Denotes factory-programmed custom frequencies.

Email [Custom\\_EconOscillators\\_Info@dalsemi.com](mailto:Custom_EconOscillators_Info@dalsemi.com) for information/questions concerning custom frequencies.

$\mu\text{MAX}$  is a registered trademark of Maxim Integrated Products, Inc.

## Typical Operating Circuit

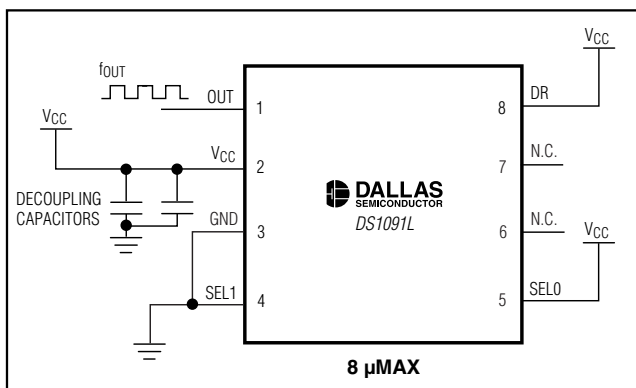

## Pin Configuration

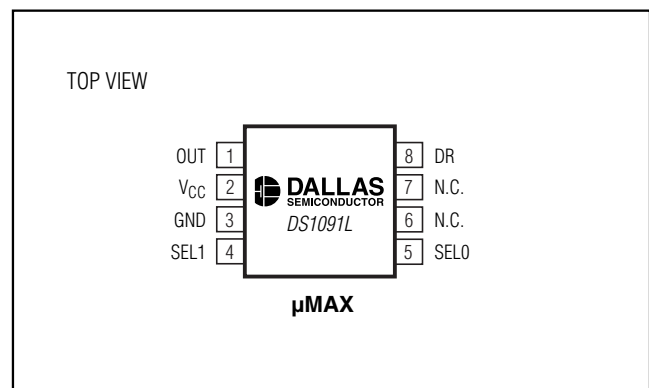

# Automotive Temperature Range Spread-Spectrum Econoscillator

## ABSOLUTE MAXIMUM RATINGS

Voltage on  $V_{CC}$  Relative to Ground .....-0.5V to +6.0V  
 Voltage on DR, SEL0, SEL1 Relative  
 to Ground\* .....-0.5V to ( $V_{CC} + 0.5V$ )

Operating Temperature Range .....-40°C to +125°C  
 Storage Temperature Range .....-55°C to +125°C  
 Soldering Temperature.....See J-STD-020 Specification

\*This voltage must not exceed 6.0V.

Stresses beyond those listed under "Absolute Maximum Ratings" may cause permanent damage to the device. These are stress ratings only, and functional operation of the device at these or any other conditions beyond those indicated in the operational sections of the specifications is not implied. Exposure to absolute maximum rating conditions for extended periods may affect device reliability.

## RECOMMENDED OPERATING CONDITIONS

( $T_A = -40^\circ\text{C}$  to  $+125^\circ\text{C}$ .)

PARAMETER	SYMBOL	CONDITIONS	MIN	TYP	MAX	UNITS
Supply Voltage	$V_{CC}$	(Note 1)	3.0	3.3	3.6	V
High-Level Input Voltage (SEL0, SEL1, DR)	$V_{IH}$		0.7 x $V_{CC}$		$V_{CC} +$ 0.3	V
Low-Level Input Voltage (SEL0, SEL1, DR)	$V_{IL}$		-0.3		0.3 x $V_{CC}$	V

## DC ELECTRICAL CHARACTERISTICS

( $T_A = -40^\circ\text{C}$  to  $+125^\circ\text{C}$ ;  $V_{CC} = +3.0V$  to  $+3.6V$ , unless otherwise noted.)

PARAMETER	SYMBOL	CONDITIONS	MIN	TYP	MAX	UNITS
High-Level Output Voltage (OUT)	$V_{OH}$	$I_{OH} = -4\text{mA}$ , $V_{CC} = 3.0V$	2.4			V
Low-Level Output Voltage (OUT)	$V_{OL}$	$I_{OL} = 4\text{mA}$			0.4	V
High-Level Input Current (SEL0, SEL1, DR)	$I_{IH}$	$V_{CC} = 3.6V$			1	$\mu\text{A}$
Low-Level Input Current (SEL0, SEL1, DR)	$I_{IL}$	$V_{IL} = 0$	-1			$\mu\text{A}$
Supply Current (Active)	$I_{CC}$	(Note 2)			16	$\text{mA}$

## AC ELECTRICAL CHARACTERISTICS

( $T_A = -40^\circ\text{C}$  to  $+125^\circ\text{C}$ ;  $V_{CC} = +3.0V$  to  $+3.6V$ , unless otherwise noted.)

PARAMETER	SYMBOL	CONDITIONS	MIN	TYP	MAX	UNITS
Output Frequency Range	$f_{OUT}$	(Note 3)	0.130		66.6	MHz
Output Center Frequency Tolerance	$\Delta f_{OUT}$	$V_{CC} = 3.3V$ , $T_A = +25^\circ\text{C}$	-0.25	0	+0.25	%
		Across $T_A$ and $V_{CC}$	-1.75		+1.75	
		$0^\circ\text{C}$ to $+70^\circ\text{C}$ , across $V_{CC}$	-1.2		+1.2	
Power-Up Time	$t_{PU}$	(Note 4)			0.1	ms
Load Capacitance	$C_L$			15	50	pF

# Automotive Temperature Range Spread-Spectrum Econoscillator

## AC ELECTRICAL CHARACTERISTICS (continued)

( $T_A = -40^{\circ}\text{C}$  to  $+125^{\circ}\text{C}$ ;  $V_{CC} = +3.0\text{V}$  to  $+3.6\text{V}$ .)

PARAMETER	SYMBOL	CONDITIONS	MIN	TYP	MAX	UNITS
Duty Cycle		< 33.3MHz (Note 3)	50			%
		$\geq 33.3\text{MHz}$ (Note 3)	40		60	
Jitter (RMS), 50MHz			0.3			%

**Note 1:** All voltages are referenced to ground. Currents entering the IC are specified positive and currents exiting the IC are negative.

**Note 2:** Supply current measured with  $C_L = 15\text{pF}$ ,  $V_{CC} = 3.6\text{V}$ ,  $T_A = 25^{\circ}\text{C}$ ,  $f_{OUT} = 66.6\text{MHz}$ , no dither.

**Note 3:** No dither.

**Note 4:** Guaranteed by design.

**Note 5:** For aging characteristics, contact factory.

## Typical Operating Characteristics

( $T_A = +25^{\circ}\text{C}$ ,  $V_{CC} = 3.3\text{V}$ , unless otherwise noted.)

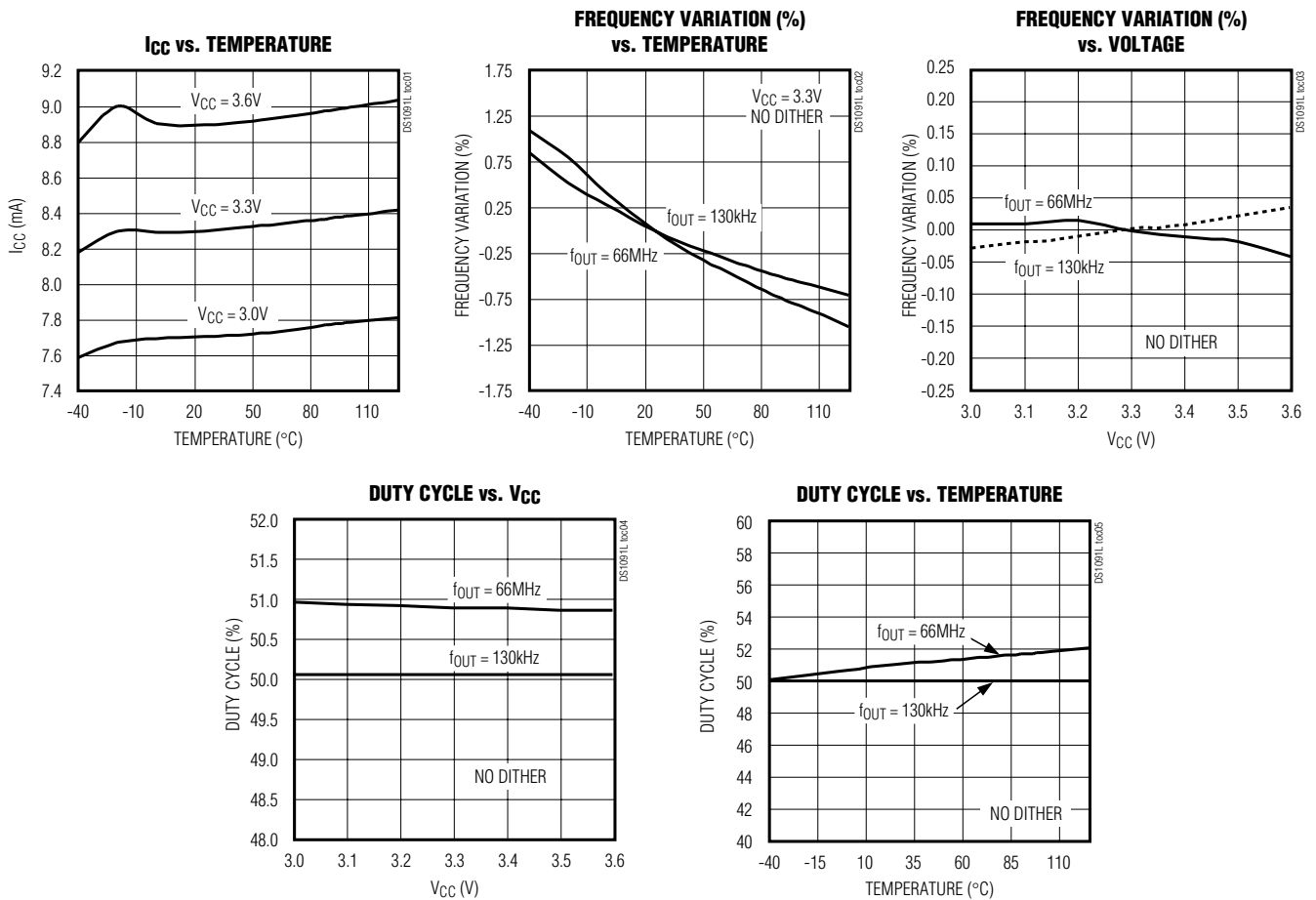

# Automotive Temperature Range Spread-Spectrum Econoscillator

## Typical Operating Characteristics (continued)

(T<sub>A</sub> = +25°C, V<sub>CC</sub> = 3.3V, unless otherwise noted.)

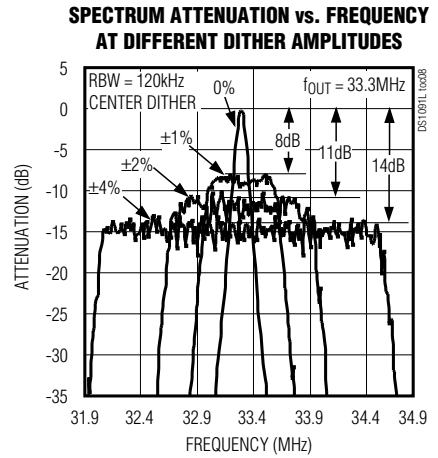
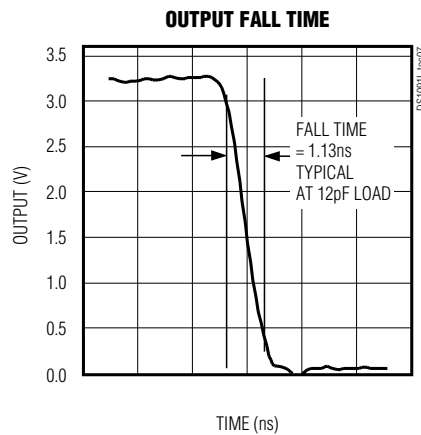
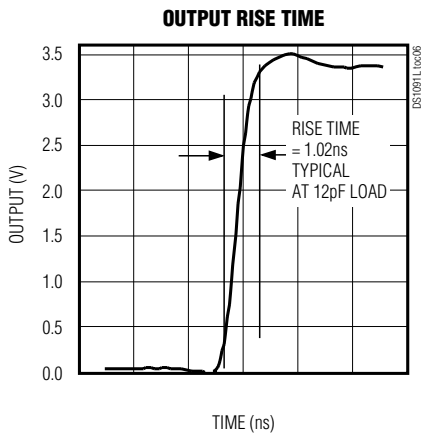

## Pin Description

PIN μMAX8	NAME	FUNCTION
1	OUT	Spread-Spectrum Clock Output
2	V <sub>CC</sub>	Supply Voltage
3	GND	Ground
4	SEL1	Spread Spectrum Dither Magnitude Select Inputs. Selects dither magnitude (see Table 1).
5	SEL0	
6, 7	N.C.	No Connection
8	DR	Spread-Spectrum Dither Rate Selector. Selects dither rate (see Table 2).

# Automotive Temperature Range Spread-Spectrum Econoscillator

## Block Diagram

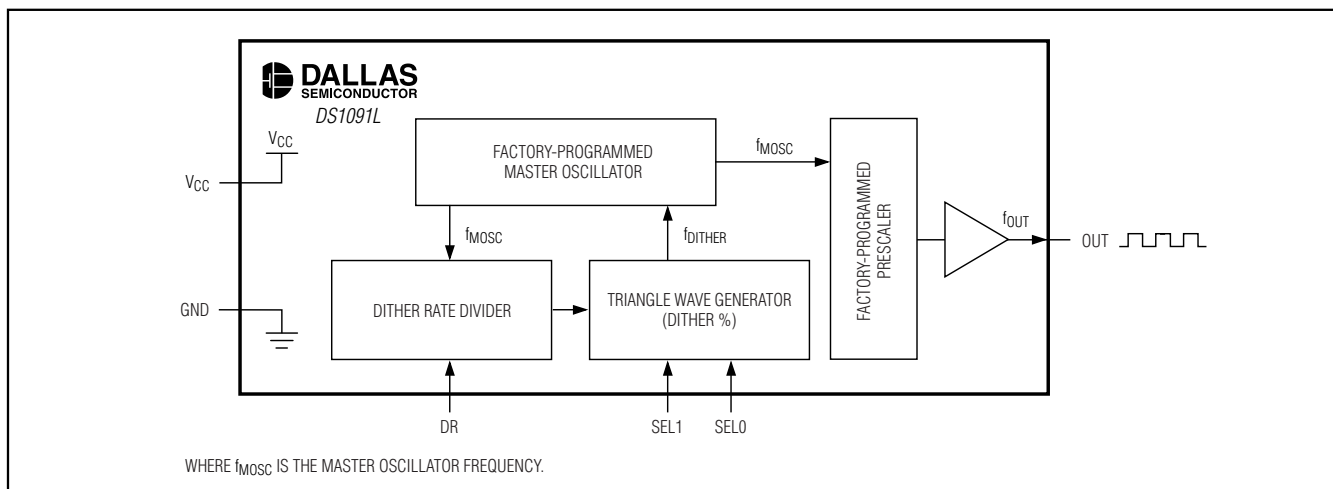

DS1091L

## Detailed Description

The DS1091L is a clock generator that is capable of output frequencies from 130kHz to 66.6MHz over the full automotive temperature range (-40°C to +125°C). The device also is capable of producing a spread-spectrum (dithered) square-wave output using four pin-selectable dither percentages. Both center (DS1091LA) and down (DS1091LB) dithering options are available. The device also features two selectable dither rates.

The DS1091L is shipped from the factory programmed to a customer-specified frequency.

## Spread Spectrum

The DS1091L has the ability to reduce radiated emission peaks. The dither percentage is controlled by the state of the SEL0 and SEL1 pins. The output frequency can be dithered at 0%, ±1%, ±2%, and ±4%, centered around the programmed frequency (for the DS1091LB this can be down dithered by 0%, -2%, -4%, and -8%).

The two select pins SEL0 and SEL1 provide a means of selecting the dither magnitudes as follows:

A triangle wave generator injects a control signal into the master oscillator to dither its output. The dither rate is a function of the output frequency,  $f_{OUT}$  as well as the setting of the DR pin (see the equation below). Figure 1 shows a plot of the output frequency versus time.

$$\text{DITHER RATE} = \frac{f_{OUT}}{2^n}$$

where  $n$  is defined in Table 2 as a function of output frequency. For example, for an output frequency of 27.0MHz, the dither rate would be 13.2kHz for DR = 0 and 6.6kHz for DR = 1.

Table 1.

SEL1 LOGIC LEVEL	SEL0 LOGIC LEVEL	DITHER MAGNITUDE	
		DS1091LA	DS1091LB
0	0	No Dither	No Dither
0	1	±1%	-2%
1	0	±2%	-4%
1	1	±4%	-8%

Table 2.

OUTPUT FREQUENCY $f_{OUT}$ (MHz)		n	
$f_{OUT}$ (min)	$f_{OUT}$ (max)	DR = LOGIC LEVEL 1	DR = LOGIC LEVEL 0
0.130	0.260	4	5
0.261	0.521	5	6
0.522	1.042	6	7
1.043	2.083	7	8
2.084	4.167	8	9
4.168	8.333	9	10
8.334	16.667	10	11
16.668	33.333	11	12
33.334	66.667	12	13

# Automotive Temperature Range Spread-Spectrum Econoscillator

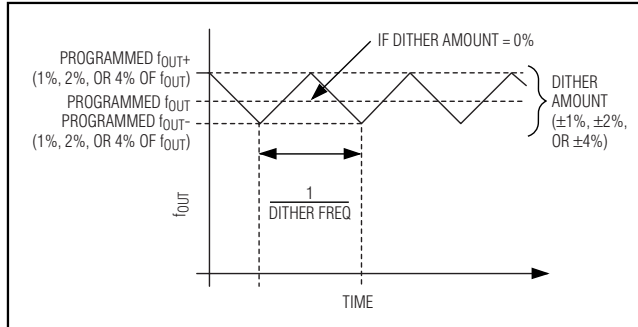

Figure 1A. Center Dithered

### Power-Up

Upon the application of power, the DS1091L output is held in the low state until  $t_{PU}$  has elapsed. This removes any possibility of erroneous output transitions during initial power-up.

### DS1091L Frequency Spreading Profile as a Function of Dither %

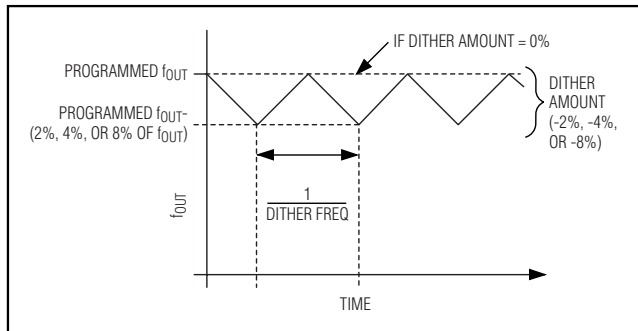

Figure 1B. Down Dithered

## Application Information

### Power-Supply Decoupling

To achieve best results, it is highly recommended that decoupling capacitors are used on the IC power-supply pins. Typical values of decoupling capacitors are 0.01 $\mu$ F and 0.1 $\mu$ F. Use a high-quality, ceramic, surface-mount capacitor, and mount it as close as possible to the VCC and GND pins of the IC to minimize lead inductance.

### Requesting Custom Frequencies

Email [Custom\\_EconOscillators\\_Info@dalsemi.com](mailto:Custom_EconOscillators_Info@dalsemi.com) for information/questions concerning custom frequencies.

## Chip Topology

TRANSISTOR COUNT: 4887

SUBSTRATE CONNECTED TO GROUND

## Package Information

For the latest package outline information, go to [www.maxim-ic.com/DallasPackInfo](http://www.maxim-ic.com/DallasPackInfo).

## Revision History

Pages changed at Rev 1: 1, 6.

Maxim cannot assume responsibility for use of any circuitry other than circuitry entirely embodied in a Maxim product. No circuit patent licenses are implied. Maxim reserves the right to change the circuitry and specifications without notice at any time.

6 **Maxim Integrated Products, 120 San Gabriel Drive, Sunnyvale, CA 94086 408-737-7600**

© 2007 Maxim Integrated Products

**MAXIM** is a registered trademark of Maxim Integrated Products, Inc.

**DALLAS SEMICONDUCTOR** is a registered trademark of Dallas Semiconductor Corporation.



SITE  
SEARCH
PART NO.  
SEARCH

WHAT'S NEW

PRODUCTS

SOLUTIONS

DESIGN

APPNOTES

SUPPORT

BUY

COMPANY

MEMBERS









## DS1091L

### Part Number Table

#### Notes:

1. See the [DS1091L QuickView Data Sheet](#) for further information on this product family or download the [DS1091L full data sheet](#) (PDF, 120kB).
2. Other options and links for purchasing parts are listed at: <http://www.maxim-ic.com/sales>.
3. [Didn't Find What You Need?](#) Ask our applications engineers. Expert assistance in finding parts, usually within one business day.
4. Part number suffixes: T or T&R = tape and reel; + = RoHS/lead-free; # = RoHS/lead-exempt. More: See [full data sheet](#) or [Part Naming Conventions](#).
5. \* Some packages have variations, listed on the drawing. "PkgCode/Variation" tells which variation the product uses.

Part Number	Free Sample	Buy Direct	Package: TYPE PINS SIZE DRAWING CODE/VAR *	Temp	RoHS/Lead-Free? Materials Analysis
DS1091LN-66+	<input type="checkbox"/>	<input type="checkbox"/>	TDFN;6 pin;118 Dwg: <a href="#">21-0137I</a> (PDF) Use pkgcode/variation: T633+1*	-40C to +85C	RoHS/Lead-Free: <a href="#">Yes</a> <a href="#">Materials Analysis</a>
DS1091LUB-066+	<input type="checkbox"/>	<input type="checkbox"/>	uSOP;8 pin;118 Dwg: <a href="#">21-0036J</a> (PDF) Use pkgcode/variation: U8+1*	-40C to +85C	RoHS/Lead-Free: <a href="#">Yes</a> <a href="#">Materials Analysis</a>
DS1091LUB-033+	<input type="checkbox"/>	<input type="checkbox"/>	uSOP;8 pin;118 Dwg: <a href="#">21-0036J</a> (PDF) Use pkgcode/variation: U8+1*	-40C to +85C	RoHS/Lead-Free: <a href="#">Yes</a> <a href="#">Materials Analysis</a>
DS1091LUB-027+	<input type="checkbox"/>	<input type="checkbox"/>	uSOP;8 pin;118 Dwg: <a href="#">21-0036J</a> (PDF) Use pkgcode/variation: U8+1*	-40C to +85C	RoHS/Lead-Free: <a href="#">Yes</a> <a href="#">Materials Analysis</a>
DS1091LUA-066+	<input type="checkbox"/>	<input type="checkbox"/>	uSOP;8 pin;118 Dwg: <a href="#">21-0036J</a> (PDF) Use pkgcode/variation: U8+1*	-40C to +85C	RoHS/Lead-Free: <a href="#">Yes</a> <a href="#">Materials Analysis</a>
DS1091LUA-033+	<input type="checkbox"/>	<input type="checkbox"/>	uSOP;8 pin;118 Dwg: <a href="#">21-0036J</a> (PDF) Use pkgcode/variation: U8+1*	-40C to +85C	RoHS/Lead-Free: <a href="#">Yes</a> <a href="#">Materials Analysis</a>
DS1091LUA-027+	<input type="checkbox"/>	<input type="checkbox"/>	uSOP;8 pin;118 Dwg: <a href="#">21-0036J</a> (PDF) Use pkgcode/variation: U8+1*	-40C to +85C	RoHS/Lead-Free: <a href="#">Yes</a> <a href="#">Materials Analysis</a>

DS1091LUB-066+T			uSOP;8 pin;118 Dwg: <a href="#">21-0036J</a> (PDF) Use pkgcode/variation: U8+1*	-40C to +85C	RoHS/Lead-Free: <a href="#">Yes</a> <a href="#">Materials Analysis</a>
DS1091LUB-033+T			uSOP;8 pin;118 Dwg: <a href="#">21-0036J</a> (PDF) Use pkgcode/variation: U8+1*	-40C to +85C	RoHS/Lead-Free: <a href="#">Yes</a> <a href="#">Materials Analysis</a>
DS1091LUB-027+T			uSOP;8 pin;118 Dwg: <a href="#">21-0036J</a> (PDF) Use pkgcode/variation: U8+1*	-40C to +85C	RoHS/Lead-Free: <a href="#">Yes</a> <a href="#">Materials Analysis</a>
DS1091LUA-066+T			uSOP;8 pin;118 Dwg: <a href="#">21-0036J</a> (PDF) Use pkgcode/variation: U8+1*	-40C to +85C	RoHS/Lead-Free: <a href="#">Yes</a> <a href="#">Materials Analysis</a>
DS1091LUA-033+T			uSOP;8 pin;118 Dwg: <a href="#">21-0036J</a> (PDF) Use pkgcode/variation: U8+1*	-40C to +85C	RoHS/Lead-Free: <a href="#">Yes</a> <a href="#">Materials Analysis</a>
DS1091LUA-027+T			uSOP;8 pin;118 Dwg: <a href="#">21-0036J</a> (PDF) Use pkgcode/variation: U8+1*	-40C to +85C	RoHS/Lead-Free: <a href="#">Yes</a> <a href="#">Materials Analysis</a>
DS1091LU-66+			uSOP;8 pin;118 Dwg: <a href="#">21-0036J</a> (PDF) Use pkgcode/variation: U8+1*	-40C to +85C	RoHS/Lead-Free: <a href="#">Yes</a> <a href="#">Materials Analysis</a>

[Didn't Find What You Need?](#)

[CONTACT US: SEND US AN EMAIL](#)