



N-Channel 80- and 90-V (D-S) MOSFETs

PRODUCT SUMMARY				
Part Number	V _{(BR)DSS} Min (V)	r _{DS(on)} Max (Ω)	V _{GS(th)} (V)	I _D (A)
VN0808L	80	4 @ V _{GS} = 10 V	0.8 to 2	0.3
VN0808LS		4 @ V _{GS} = 10 V	0.8 to 2	0.33
VQ1006P	90	4 @ V _{GS} = 10 V	0.8 to 2.5	0.4

FEATURES

- Low On-Resistance: 3.6 Ω
- Low Threshold: 1.6 V
- Low Input Capacitance: 35 pF
- Fast Switching Speed: 6 ns
- Low Input and Output Leakage

BENEFITS

- Low Offset Voltage
- Low-Voltage Operation
- Easily Driven Without Buffer
- High-Speed Circuits
- Low Error Voltage

APPLICATIONS

- Direct Logic-Level Interface: TTL/CMOS
- Drivers: Relays, Solenoids, Lamps, Hammers, Displays, Memories, Transistors, etc.
- Battery Operated Systems
- Solid-State Relays

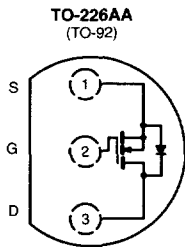

Top View
VN0808L

Front View:
VN0808L

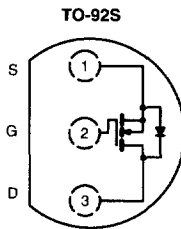

Top View
VN0808LS

Front View:

VN0808LS



"S" = Siliconix Logo
f = Factory Code
// = Lot Traceability
xxyy = Date Code

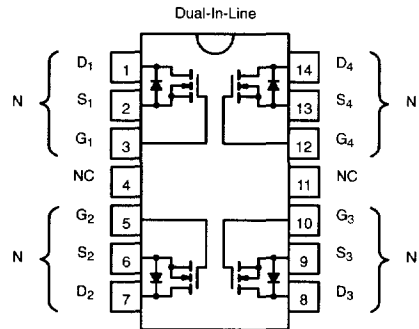

Top View
Sidebraze: VQ1006P

Top View:

VQ1006P



ABSOLUTE MAXIMUM RATINGS (T_A = 25°C UNLESS OTHERWISE NOTED)

Parameter	Symbol	VN0808L	VN0808LS	VQ1006P		Unit	
				Single	Total Quad		
Drain-Source Voltage	V _{DS}	80	80	90		V	
Gate-Source Voltage	V _{GS}	± 30	± 30	± 20		V	
Continuous Drain Current (T _J = 150°C)	I _D	T _A = 25°C	0.3	0.33	0.4		A
		T _A = 100°C	0.19	0.21	0.23		
Pulsed Drain Current ^a	I _{DM}	1.9	1.9	2		A	
Power Dissipation	P _D	T _A = 25°C	0.8	0.9	1.3	2	W
		T _A = 100°C	0.32	0.4	0.52	0.8	
Thermal Resistance, Junction-to-Ambient	R _{thJA}	156	139	96	62.5	°C/W	
Operating Junction and Storage Temperature Range	T _J , T _{stg}	-55 to 150					°C

Notes
a. Pulse width limited by maximum junction temperature.



SPECIFICATIONS (T _A = 25 °C UNLESS OTHERWISE NOTED)								
Parameter	Symbol	Test Conditions	Typ ^a	Limits				Unit
				VN0808L/LS		VQ1006P		
				Min	Max	Min	Max	
Static								
Drain-Source Breakdown Voltage	V _{(BR)DSS}	V _{GS} = 0 V, I _D = 10 μA	125	80		90		V
Gate-Threshold Voltage	V _{GS(th)}	V _{DS} = V _{GS} , I _D = 1 mA	1.6	0.8	2	0.8	2.5	
Gate-Body Leakage	I _{GSS}	V _{DS} = 0 V, V _{GS} = ±15 V T _J = 125 °C			±100		±100	nA
Zero Gate Voltage Drain Current	I _{DSS}	V _{DS} = 80 V, V _{GS} = 0 V T _J = 125 °C			10			μA
		V _{DS} = 72 V, V _{GS} = 0 V T _J = 125 °C			500		1	
							500	
On-State Drain Current ^b	I _{D(on)}	V _{DS} = 10 V, V _{GS} = 10 V	1.8	1.5		1.5		A
Drain-Source On-Resistance ^b	r _{DS(on)}	V _{GS} = 5 V, I _D = 0.3 A	3.8				5	Ω
		V _{GS} = 10 V, I _D = 1 A	3.6		4		4.5	
		T _J = 125 °C	6.7		8		8.6	
Forward Transconductance ^b	g _{fs}	V _{DS} = 10 V, I _D = 0.5 A	350	170		170		mS
Common Source Output Conductance ^b	g _{cs}	V _{DS} = 10 V, I _D = 0.1 A	0.23					
Dynamic								
Input Capacitance	C _{iss}	V _{DS} = 25 V, V _{GS} = 0 V, f = 1 MHz	35		50		60	pF
Output Capacitance	C _{oss}		15		40		50	
Reverse Transfer Capacitance	C _{rss}		2		10		10	
Switching^c								
Turn-On Time	t _{ON}	V _{DD} = 25 V, R _L = 23 Ω I _D = 1 A, V _{GEN} = 10 V R _G = 25 Ω	6		10		10	ns
Turn-Off Time	t _{OFF}		8		10		10	

Notes

- a. For DESIGN AID ONLY, not subject to production testing..
- b. Pulse test: PW ≤ 300 μs duty cycle ≤ 2%.
- c. Switching time is essentially independent of operating temperature.

VNDQ09



TYPICAL CHARACTERISTICS (T_A = 25°C UNLESS OTHERWISE NOTED)

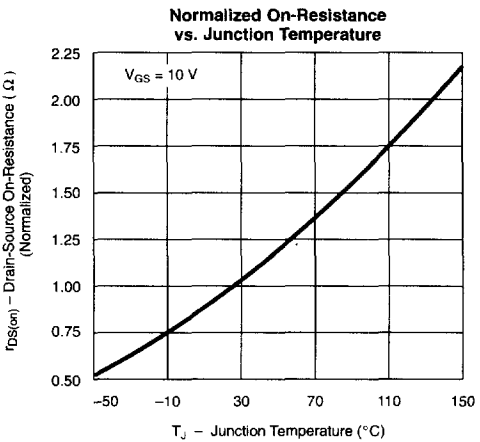
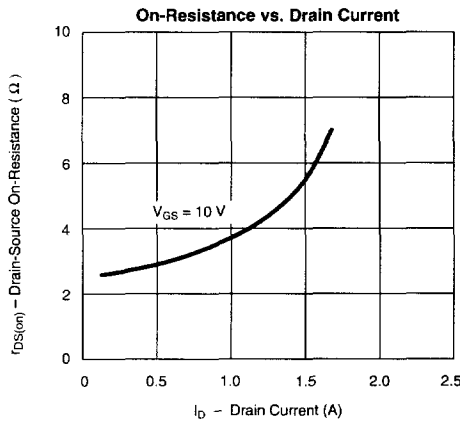
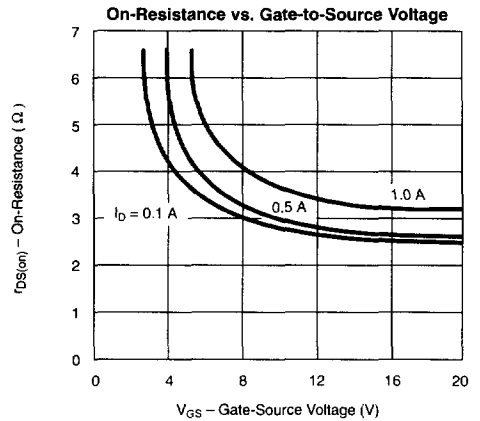
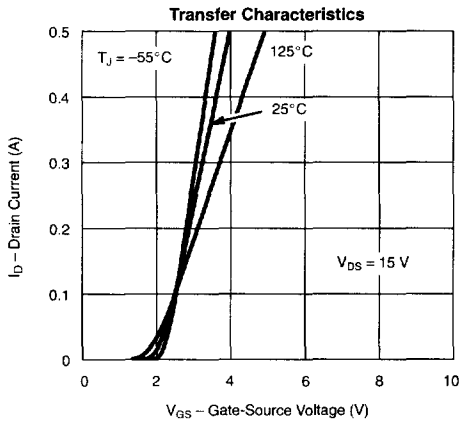
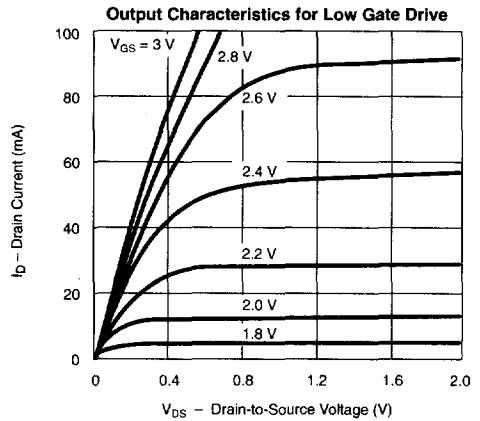
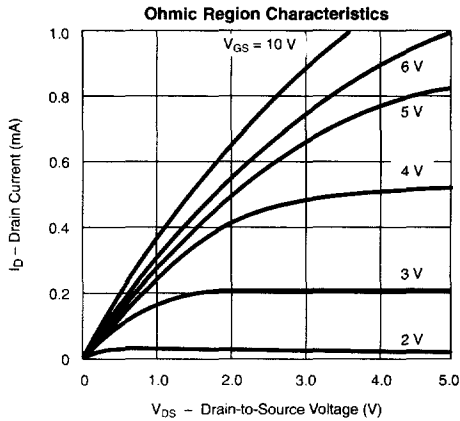



TYPICAL CHARACTERISTICS ($T_A = 25^\circ\text{C}$ UNLESS OTHERWISE NOTED)

