



LIGHTING FOREVER

# 4 PIN SOP ZERO CROSS TRIAC PHOTOCOUPLER

ELM304X Series  
ELM306X Series  
ELM308X Series

## Features:

- ELM304X  $V_{DRM}$  of 400V, ELM306X  $V_{DRM}$  of 600V and ELM308X  $V_{DRM}$  of 800V
- High isolation voltage between input and output ( $V_{iso}=3750$  V rms )
- Zero voltage crossing
- Pb free and RoHS compliant.
- UL approved (No. E214129)
- VDE approved (No.40028116)
- SEMKO approved
- NEMKO approved
- DEMKO approved
- FIMKO approved



## Schematic

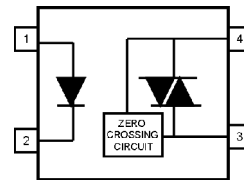

## Description

The ELM304X, ELM306X and ELM308X devices consist of a GaAs infrared emitting diode optically coupled to a monolithic silicon detector performing the function of a zero voltage crossing bilateral triac driver.

They are designed for use with a discrete power triac in the interface of logic systems to equipment powered from 110 to 240 VAC lines, such as solid-state relays, industrial controls, motors, solenoids and consumer appliances, etc.

## Applications

- Solenoid/valve controls
- Light controls
- Static power switch
- AC motor drivers
- E.M. contactors
- Temperature controls
- AC Motor starters
- Solid state relays

## Pin Configuration

1. Anode
2. Cathode
3. Terminal
4. Terminal



LIGHTING FOREVER

# 4 PIN SOP ZERO CROSS TRIAC PHOTOCOUPLER

**ELM304X Series**  
**ELM306X Series**  
**ELM308X Series**

## Absolute Maximum Ratings (T<sub>a</sub>=25°C)

Parameter		Symbol	Rating	Unit
Input	Forward current	I <sub>F</sub>	60	mA
	Peak forward current (1us pulse, 300pps)	I <sub>F(PK)</sub>	1	A
	Reverse voltage	V <sub>R</sub>	6	V
	Power dissipation	P <sub>D</sub>	100	mW
Output	Off-state Output Terminal Voltage	M304X	400	V
		M306X	600	
		M308X	800	
	On state RMS Current	I <sub>T(RMS)</sub>	70	mA(RMS)
Power dissipation		P <sub>D</sub>	300	mW
Isolation voltage *1		V <sub>iso</sub>	3750	V rms
Operating temperature		T <sub>opr</sub>	-40~+110	°C
Storage temperature		T <sub>stg</sub>	-55~+150	°C
Soldering temperature *2		T <sub>sol</sub>	260	°C

### Notes

\*1 AC for 1 minute, R.H.= 40 ~ 60% R.H. In this test, pins 1, 2 & 3 are shorted together, and pins 4, 5 & 6 are shorted together.

\*2 For 10 seconds.



LIGHTING FOREVER

# 4 PIN SOP ZERO CROSS TRIAC PHOTOCOUPLER

**ELM304X Series**  
**ELM306X Series**  
**ELM308X Series**

## Electrical Characteristics (T<sub>a</sub>=25°C unless specified otherwise)

### Input

Parameter	Symbol	Min.	Typ.*	Max.	Unit	Condition
Forward voltage	V <sub>F</sub>	-	-	1.5	V	I <sub>F</sub> = 30mA
Reverse Leakage current	I <sub>R</sub>	-	-	10	μA	V <sub>R</sub> = 6V

### Output

Parameter	Symbol	Min.	Typ.*	Max.	Unit	Condition
Peak Blocking Current	I <sub>DRM1</sub>	-	-	100	nA	V <sub>DRM</sub> = Rated V <sub>DRM</sub> I <sub>F</sub> = 0mA
Peak On-state Voltage	V <sub>TM</sub>	-	-	3	V	I <sub>TM</sub> =100mA peak
Critical Rate of Rise off-state Voltage	dv/dt	1000	-	-	V/μs	
Inhibit Voltage (MT1-MT2 voltage above which device will not trigger)	V <sub>INH</sub>	-	-	20	V	I <sub>F</sub> = Rated I <sub>FT</sub>
Leakage in Inhibited State	I <sub>DRM2</sub>	-	-	1000	μA	I <sub>F</sub> = Rated I <sub>FT</sub> , V <sub>DRM</sub> =Rated V <sub>DRM</sub> , off state

### Transfer Characteristics

Parameter	Symbol	Min.	Typ.*	Max.	Unit	Condition
LED Trigger Current	3042 3062 3082	-	-	10	mA	Main terminal Voltage=3V
	3043 3063 3083	-	-	5		
	3044 3064 3084	-	-	3		
Holding Current	I <sub>H</sub>	-	280	-	μA	

\* Typical values at T<sub>a</sub> = 25°C



LIGHTING FOREVER

# 4 PIN SOP ZERO CROSS TRIAC PHOTOCOUPLER

## ELM304X Series ELM306X Series ELM308X Series

### Typical Performance Curves

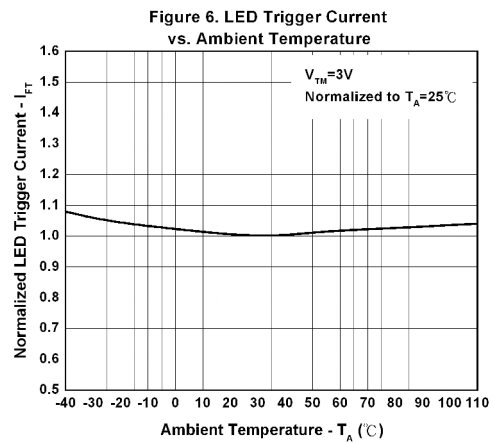
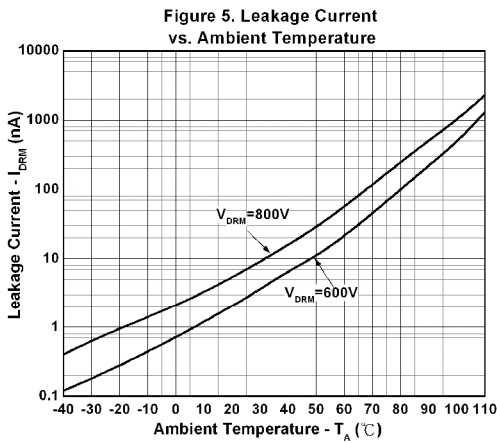
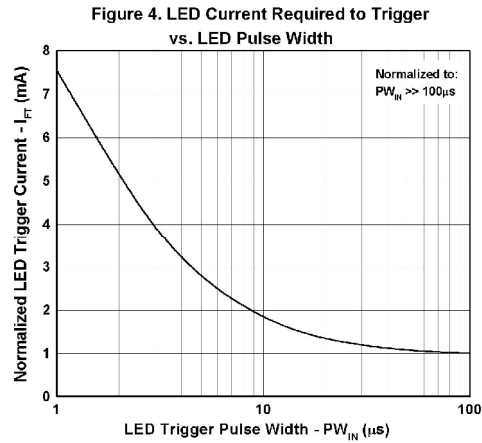
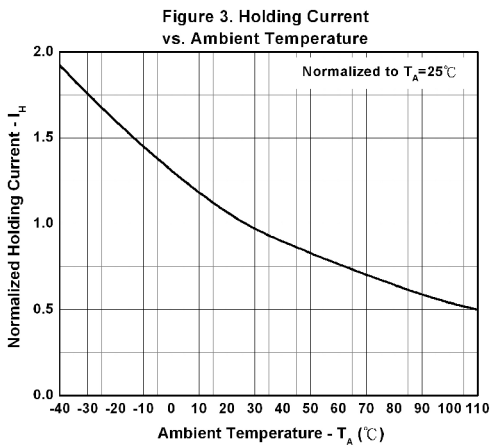
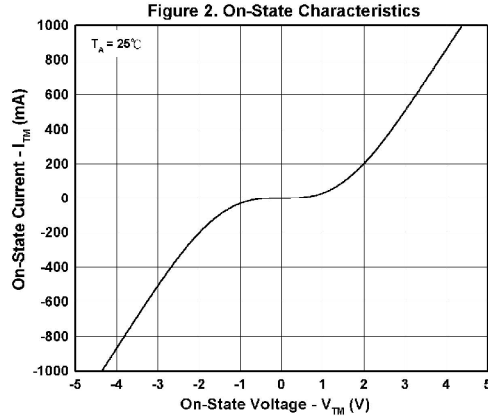
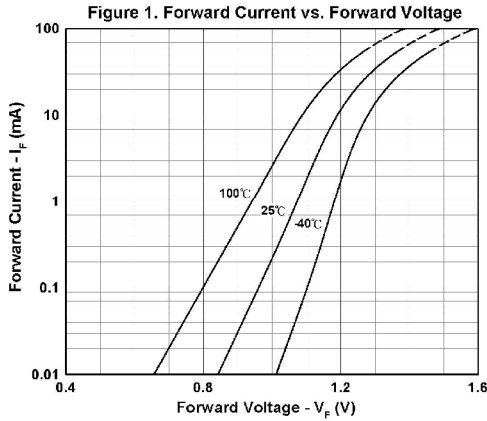



LIGHTING FOREVER

# 4 PIN SOP ZERO CROSS TRIAC PHOTOCOUPLER

ELM304X Series  
ELM306X Series  
ELM308X Series

Figure 7. Off-State Output Terminal Voltage vs. Ambient Temperature

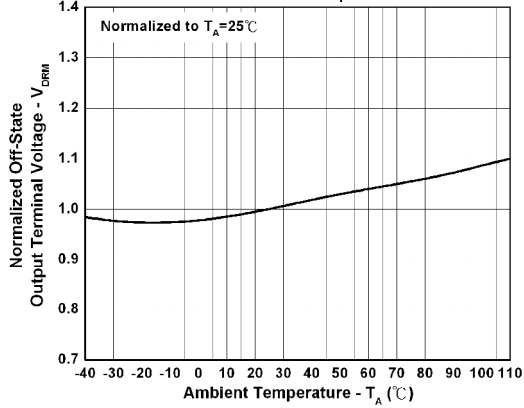

Figure 8. Leakage in Inhibit State vs. Ambient Temperature

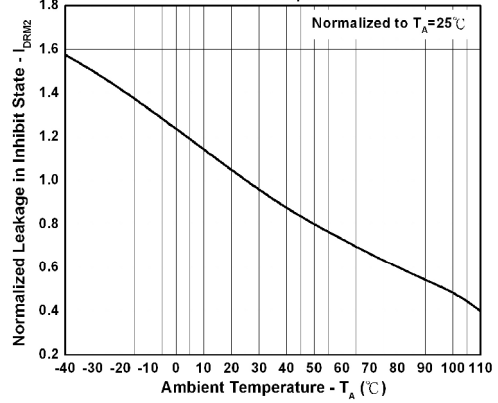
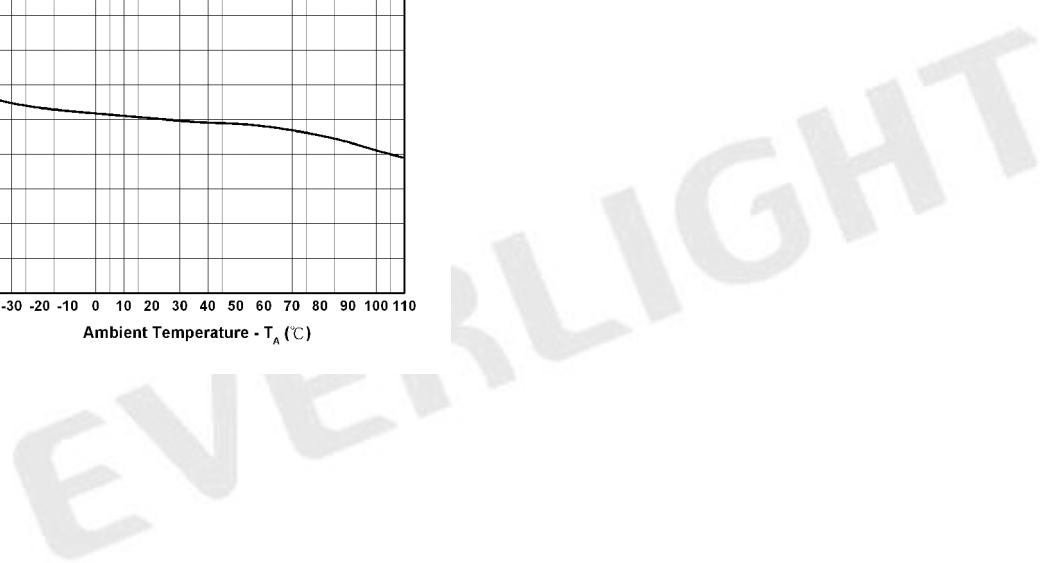
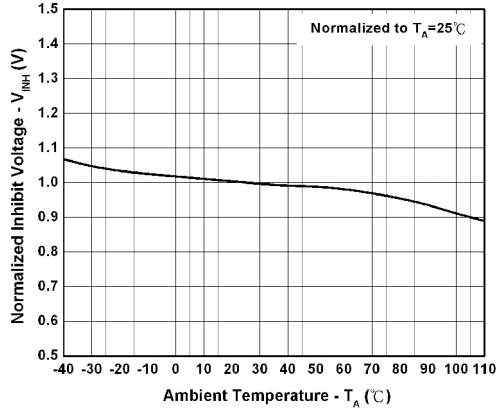
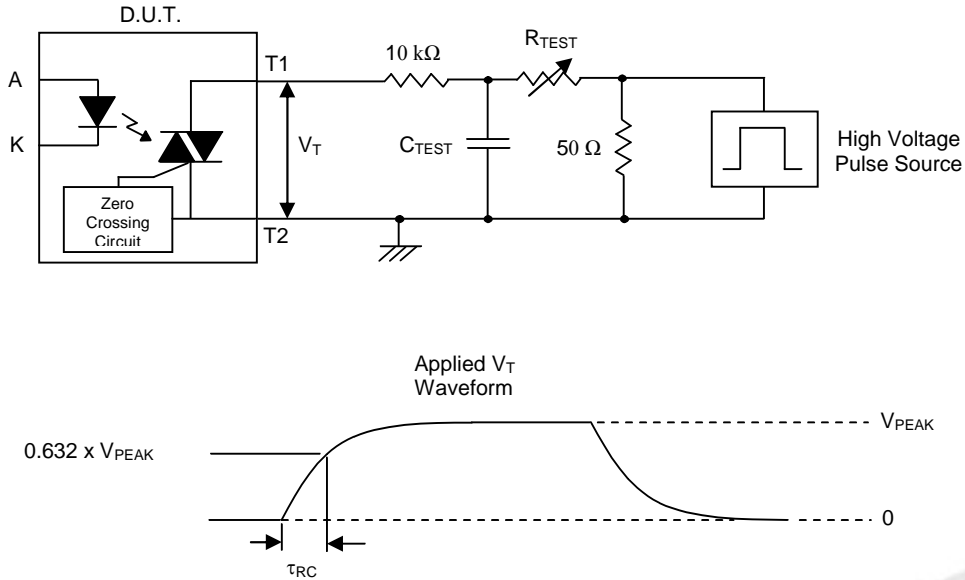

Figure 9. Inhibit Voltage vs. Ambient Temperature



**Figure 10. Static dv/dt Test Circuit & Waveform**



**Measurement Method**

The high voltage pulse is set to the required  $V_{PEAK}$  value and applied to the D.U.T. output side through the RC circuit above. LED current is not applied. The waveform  $V_T$  is monitored using a x100 scope probe. By varying  $R_{TEST}$ , the dv/dt (slope) is increased, until the D.U.T. is observed to trigger (waveform collapses). The dv/dt is then decreased until the D.U.T. stops triggering. At this point,  $\tau_{RC}$  is recorded and the dv/dt calculated.

$$dv/dt = \frac{0.632 \times V_{PEAK}}{\tau_{RC}}$$

For example,  $V_{PEAK} = 600V$  for EL306X series. The dv/dt value is calculated as follows:

$$dv/dt = \frac{0.63 \times 600}{\tau_{RC}} = \frac{378}{\tau_{RC}}$$



LIGHTING FOREVER

# 4 PIN SOP ZERO CROSS TRIAC PHOTOCOUPLER

**ELM304X Series**  
**ELM306X Series**  
**ELM308X Series**

## Order Information

### Part Number

**ELM304X(Z)-V**  
or **ELM306X(Z)-V**  
or **ELM308X(Z)-V**

#### Note

X = Part No. (2 for  $I_{FT}=10mA$ , 3 for  $I_{FT}=5mA$ , 4 for  $I_{FT}=3mA$ )  
Z = Tape and reel option (TA, TB or none).  
V = VDE safety approved optional

Option	Description	Packing quantity
None	Standard	100 units per tube
None	Standard + VDE safety optional	100 units per tube
(TA)	TA tape & reel option	3000 units per reel
(TB)	TB tape & reel option	3000 units per reel
(TA)-V	TA tape & reel option + VDE safety optional	3000 units per reel
(TB)-V	TB tape & reel option + VDE safety optional	3000 units per reel

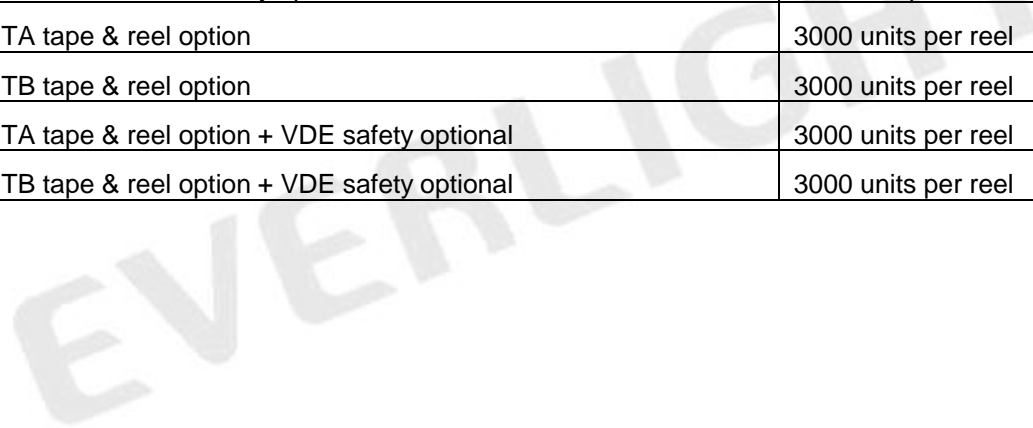



LIGHTING FOREVER

# 4 PIN SOP ZERO CROSS TRIAC PHOTOCOUPLER

ELM304X Series  
ELM306X Series  
ELM308X Series

## Package Drawings

(Dimensions in mm)

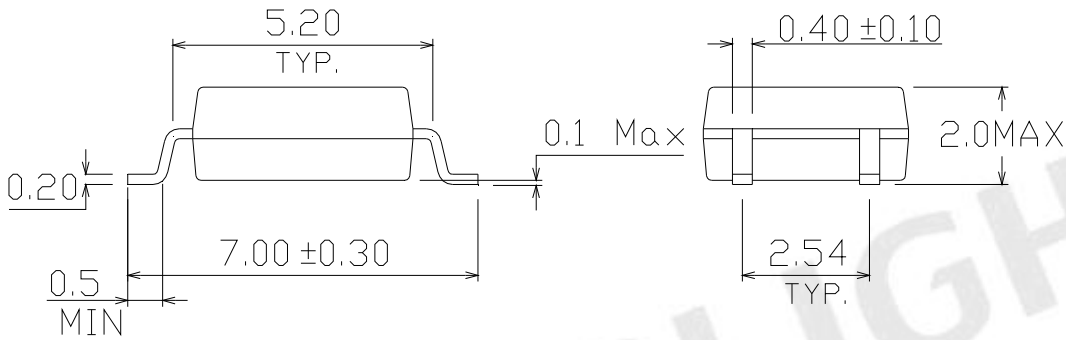
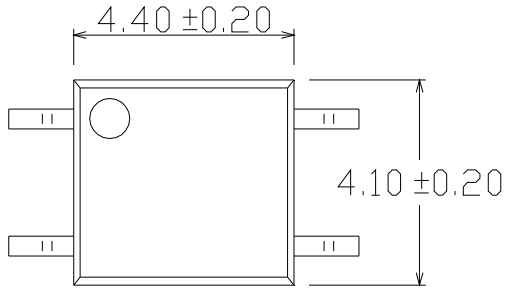

## Recommended pad layout for surface mount leadform

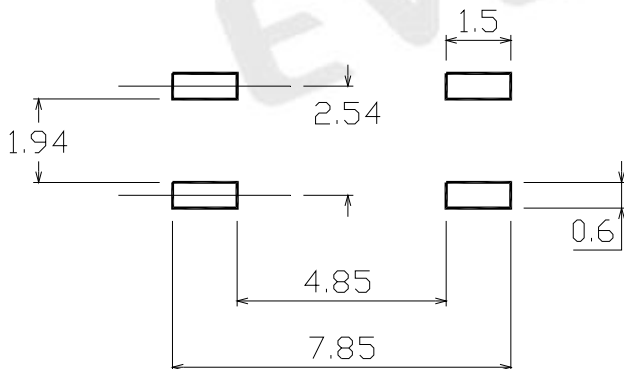





LIGHTING FOREVER

# 4 PIN SOP ZERO CROSS TRIAC PHOTOCOUPLER

ELM304X Series  
ELM306X Series  
ELM308X Series

## Device Marking



## Notes

EL denotes Everlight  
M3063 denotes Device Number  
Y denotes 1 digit Year code  
WW denotes 2 digit Week code  
V denotes VDE safety (optional)

EVERLIGHT



LIGHTING FOREVER

# 4 PIN SOP ZERO CROSS TRIAC PHOTOCOUPLER

**ELM304X Series**  
**ELM306X Series**  
**ELM308X Series**

## Tape & Reel Packing Specifications

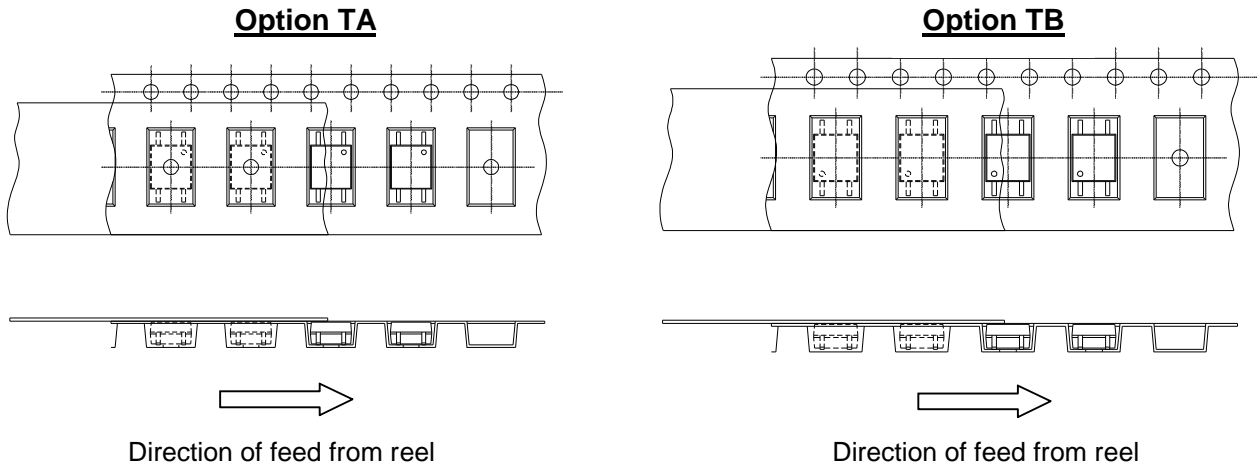

## Tape dimensions

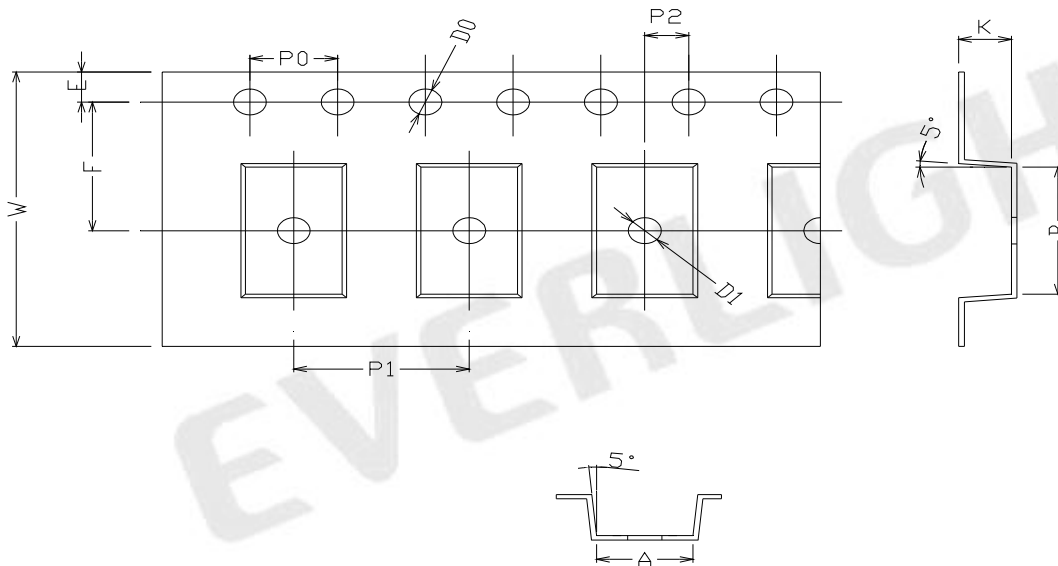

Dimension No.	A	B	Do	D1	E	F
Dimension (mm)	4.4 ± 0.1	7.4 ± 0.1	1.5 + 0.1/-0	1.5 ± 0.1	1.7 5 ± 0.1	7.5 ± 0.1
Dimension No.	Po	P1	P2	t	W	K
Dimension (mm)	4.0 ± 0.15	8.0 ± 0.1	2.0 ± 0.1	0.25 ± 0.03	16.0 ± 0.2	2.4 ± 0.1



LIGHTING FOREVER

# 4 PIN SOP ZERO CROSS TRIAC PHOTOCOUPLER

ELM304X Series  
ELM306X Series  
ELM308X Series

## Solder Reflow Temperature Profile

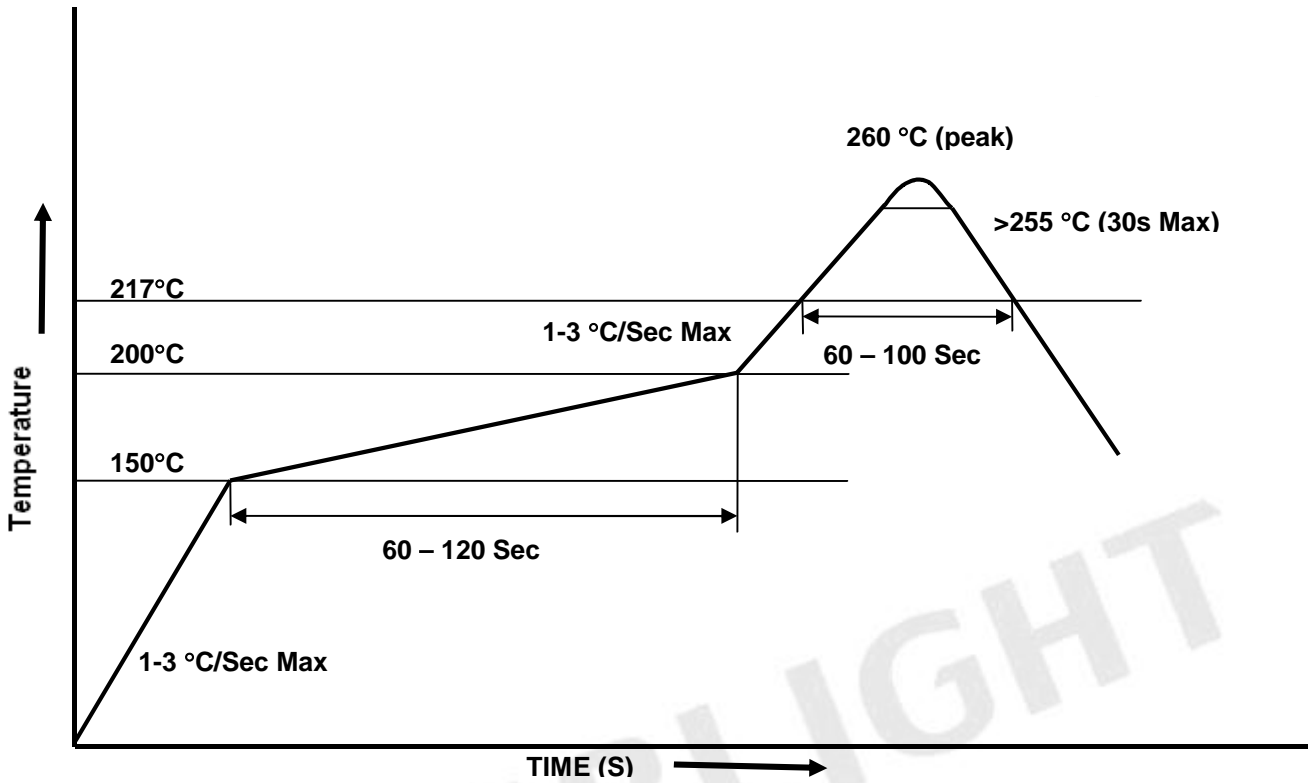



LIGHTING FOREVER

## 4 PIN SOP ZERO CROSS TRIAC PHOTOCOUPLER

ELM304X Series  
ELM306X Series  
ELM308X Series

---

### DISCLAIMER

1. Above specification may be changed without notice. EVERLIGHT will reserve authority on material change for above specification.
2. When using this product, please observe the absolute maximum ratings and the instructions for use outlined in these specification sheets. EVERLIGHT assumes no responsibility for any damage resulting from use of the product which does not comply with the absolute maximum ratings and the instructions included in these specification sheets.
3. These specification sheets include materials protected under copyright of EVERLIGHT corporation. Please don't reproduce or cause anyone to reproduce them without EVERLIGHT's consent.

EVERLIGHT