



Features

1. High current transfer ratio.
(CTR: MIN. 600% at $I_F = 1\text{mA}$, $V_{CE} = 2\text{V}$)
2. High isolation voltage between input and output
(Viso: 5000Vrms).
3. Compact dual-in-line package.
4. Available package types: DIP(shown)/ SMD/ H(Page 4).

Applications

2. System appliances, measuring instruments.
2. Industrial robots.
3. Copiers, automatic vending machines.
7. Signal transmission between circuits of different potentials and impedances.

Part Numbering System: Page 1. **Part Marking System:** Page 1.

Outside Dimension: Unit (mm)

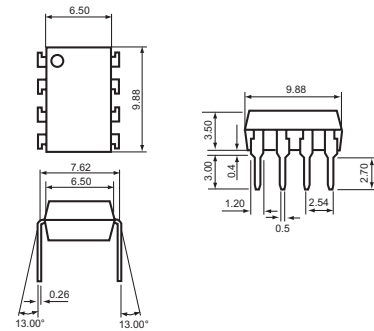

Tolerance: $\pm 0.2\text{mm}$

Schematic: Top View

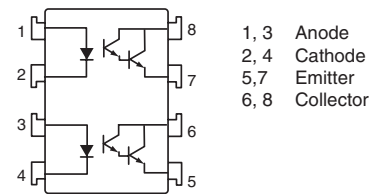

Absolute Maximum Ratings

($T_a = 25^\circ\text{C}$)

Parameter		Symbol	Rating	Unit
Input	Forward Current	I_F	50	mA
	Peak Forward Current	I_{FM}	1	A
	Reverse Voltage	V_R	6	V
	Power Dissipation	P_D	70	mW
Output	Collector-emitter voltage	V_{CEO}	35	V
	Emitter-collector voltage	V_{ECO}	6	V
	Collector current	I_C	80	mA
	Collector power dissipation	P_C	150	mW
Total Power Dissipation		P_{tot}	200	mW
Isolation Voltage 1 minute		Viso	5000	Vrms
Operating Temperature		T_{opr}	-30 to +100	$^\circ\text{C}$
Storage Temperature		T_{stg}	-55 to +125	$^\circ\text{C}$
Solder Temperature 10 seconds		T_{sol}	260	$^\circ\text{C}$

Electro-optical Characteristics

($T_a = 25^\circ\text{C}$)

Parameter		Symbol	Conditions	Min.	Typ.	Max.	Unit
Input	Forward Voltage	V_F	$I_F = 20\text{mA}$	-	1.2	1.4	V
	Peak Forward Voltage	V_{FM}	$I_{FM} = 0.5\text{A}$	-	-	3.5	V
	Reverse Current	I_R	$V_R = 4\text{V}$	-	-	10	μA
	Terminal Capacitance	C_t	$V = 0$, $f = 1\text{kHz}$	-	30	250	pF
Output	Collector dark current	I_{CEO}	$V_{CE} = 10\text{V}$, $I_F = 0$	-	-	1.0	μA
Transfer Characteristics	Current transfer ratio	CTR	$I_F = 1\text{mA}$, $V_{CE} = 2\text{V}$	600	-	7500	%
	Collector-Emitter Saturation Voltage	$V_{CE(sat)}$	$I_F = 20\text{mA}$, $I_C = 5\text{mA}$	-	0.8	1.0	V
	Isolation resistance	Riso	DC500V, 40 to 60% RH	5×10^{10}	-	-	ohm
	Floating capacitance	C_f	$V = 0$, $f = 1\text{MHz}$	-	0.6	1.0	pF
	Cut-off frequency	f_c	$V_{CC} = 2\text{V}$, $I_C = 20\text{mA}$, $R_L = 100\Omega$	1	6	-	kHz
	Response time (Rise)	t_r	$V_{ce} = 2\text{V}$, $I_C = 20\text{mA}$, $R_L = 100\Omega$	-	80	300	μs
Response time (Fall)	t_f	-		72	250	μs	

Data Curves

Rank CTR(%)
E 600-7500

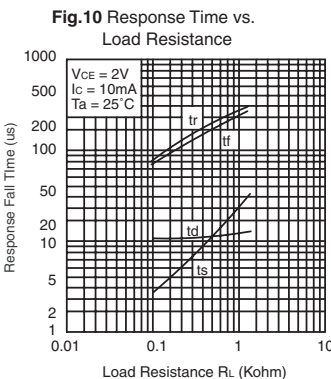
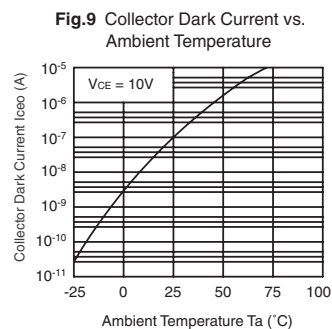
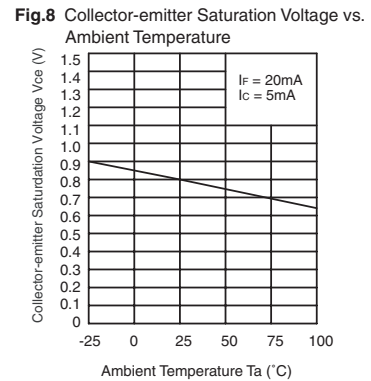
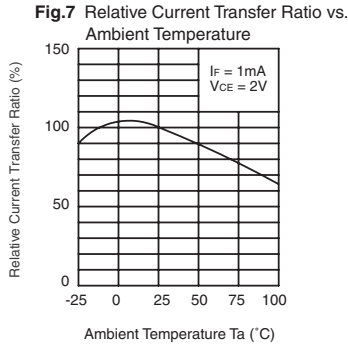
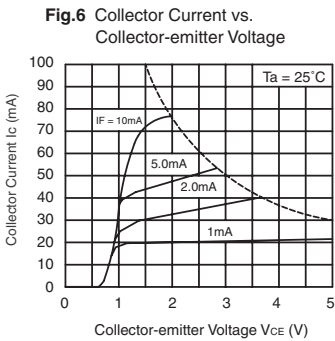
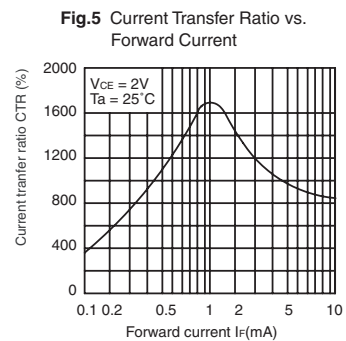
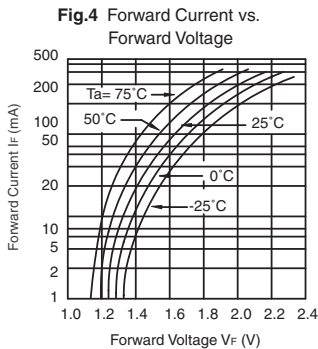
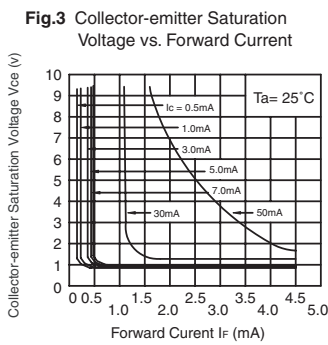
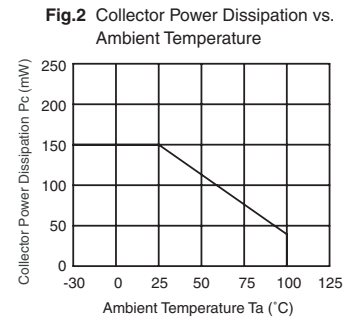
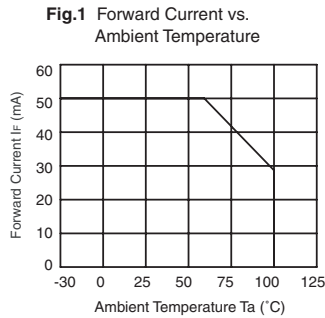



Part Numbering System

STANDARD, DIGITAL HIGH SPEED, SOP, & SSOP

Example Part Number:

WPPC - D 2 2 035 8 E D - TRU
(1) (2) (3) (4) (5) (6) (7) (8) (9)

(1) Photo Coupler

(2) Input

A: AC
D: DC

(3) Channel

1: 1 Channel
2: 2 Channels
4: 4 Channels

(4) Output Configuration

1: Single Photo Transistor
2: Darlington Photo Transistor
3: (6-pin only)
Single Photo Transistor
without base terminal

(5) Output Type

Collector Emitter Voltage

03: 30V (V_{CEO})
035: 35V (V_{CEO})
06: 60V (V_{CEO})
08: 80V (V_{CEO})
30: 300V (V_{CEO})

Propagation Delay Time

D008: 1M bit/s*
D015: 1M bit/s*
D35: High Gain Split PD*
D60: High Gain Split PD*

*Digital High Speed Parts:
code denotes max propagation delay

(6) Pin Configuration

4: 4 pin
6: 6 pin
8: 8 pin
16: 16 pin

(7) CTR Ranking

A
B
C
D
E = 600 to 7500
F
G

Note: No CTR Ranking for Digital High Speed Parts

(8) Package Types

D: DIP
A: SMD
S: SOP
SS: SSOP
H: Long Creepage Distance

(9) Taping

TLD: Tape Direction Left
TRU: Tape Direction Right

Not all combinations are available

Part Marking System

STANDARD

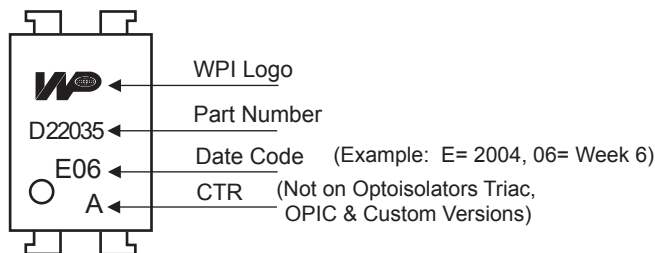

SSOP

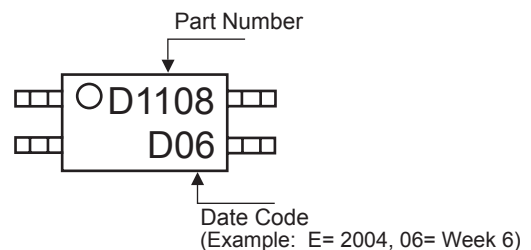

Additional Package Types

SMD 8-pin

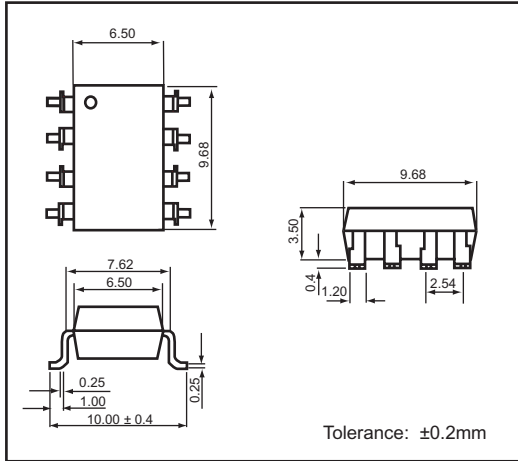

H 8-pin

