

RELATIVE POSSIBLE POSITION
OF ROTATED MASTER KEY
SEE 9-2437-7
(FRONT FACE OF SHELL SHOWN)

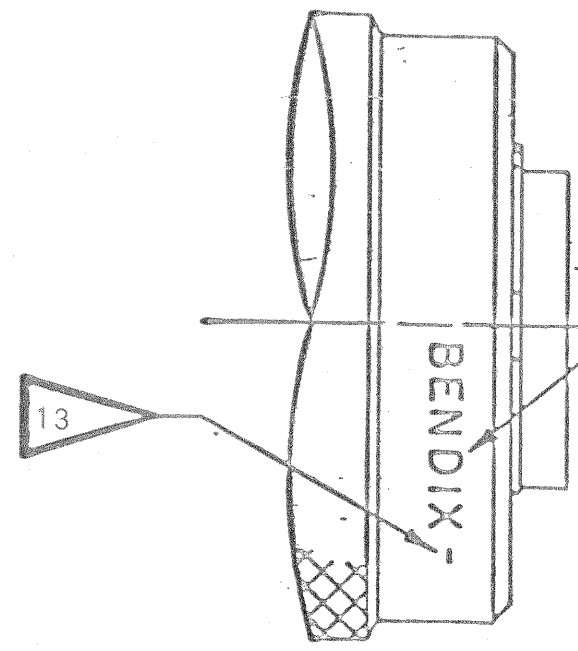

STAMP AMPHENOL, AND LJT NO.
PER 9-5788
EXAMPLE:
LJT06RT-11-5P (155)
FOR ROTATED MASTER KEY
EXAMPLE:
LJT06RT-11-5PA(155)

76500-209

ZONE		DESCRIPTION	DATE	APPROVED
A1				
A2		REV CONTACTS; STANDARDIZED ECN: CNR	G. OVER 6/2/75	<i>[Signature]</i>
B		(MFG) WAS CONTACTS 10-251415-XX5 & 10-407035-XX5 ECN: CNR	DE MATTEO 1/10/79	<i>[Signature]</i> 1-10-79
C		(CLIE) PARTS LIST CHANGE = PIN 10-525547-92F CHARGED PLUG SHELL 10-417811-D11 (WAS: 10-417810-D11) ECN: 84088	11-5-98 V. Jones	<i>[Signature]</i>

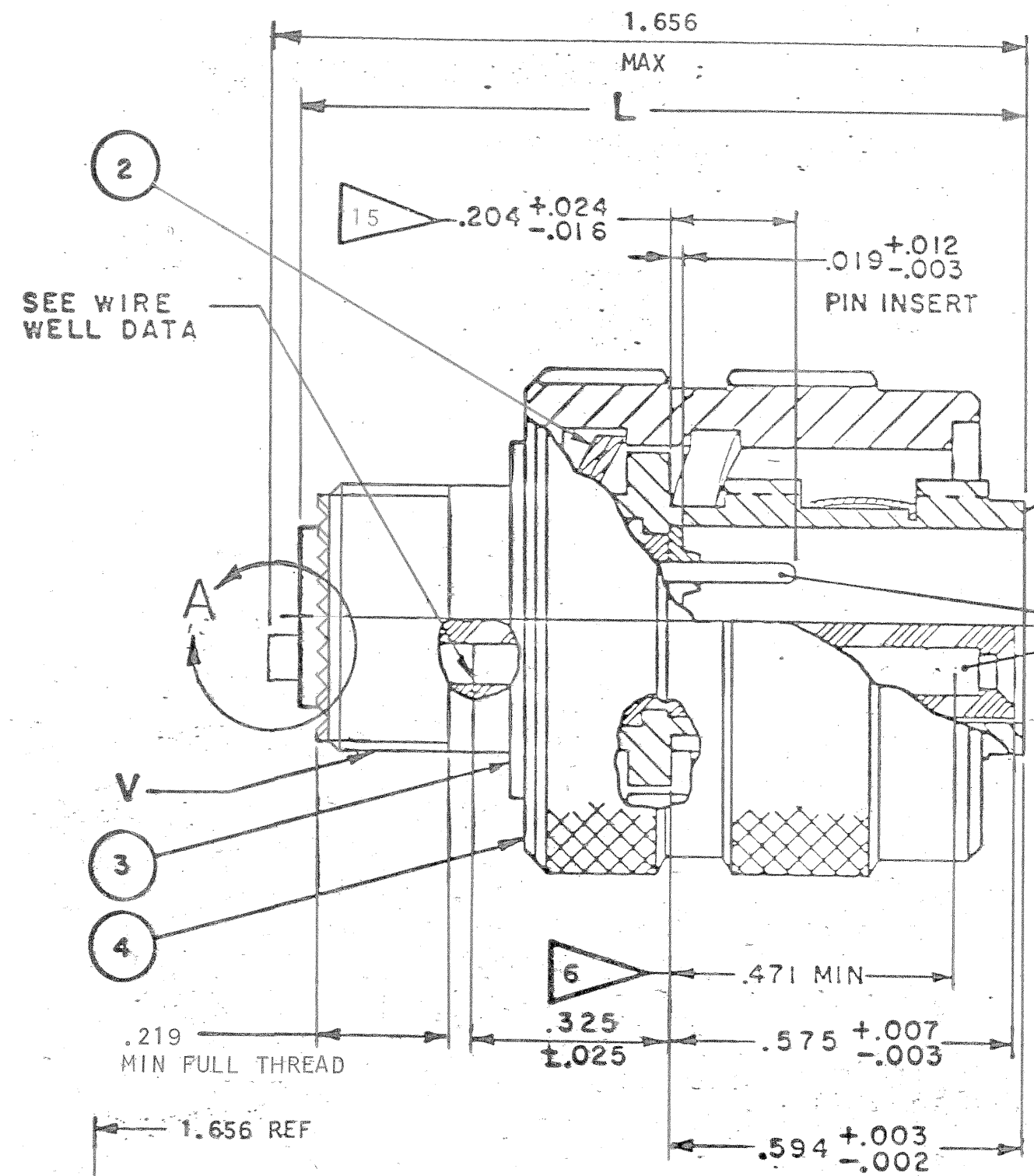

SEE WIRE
WELL DATA

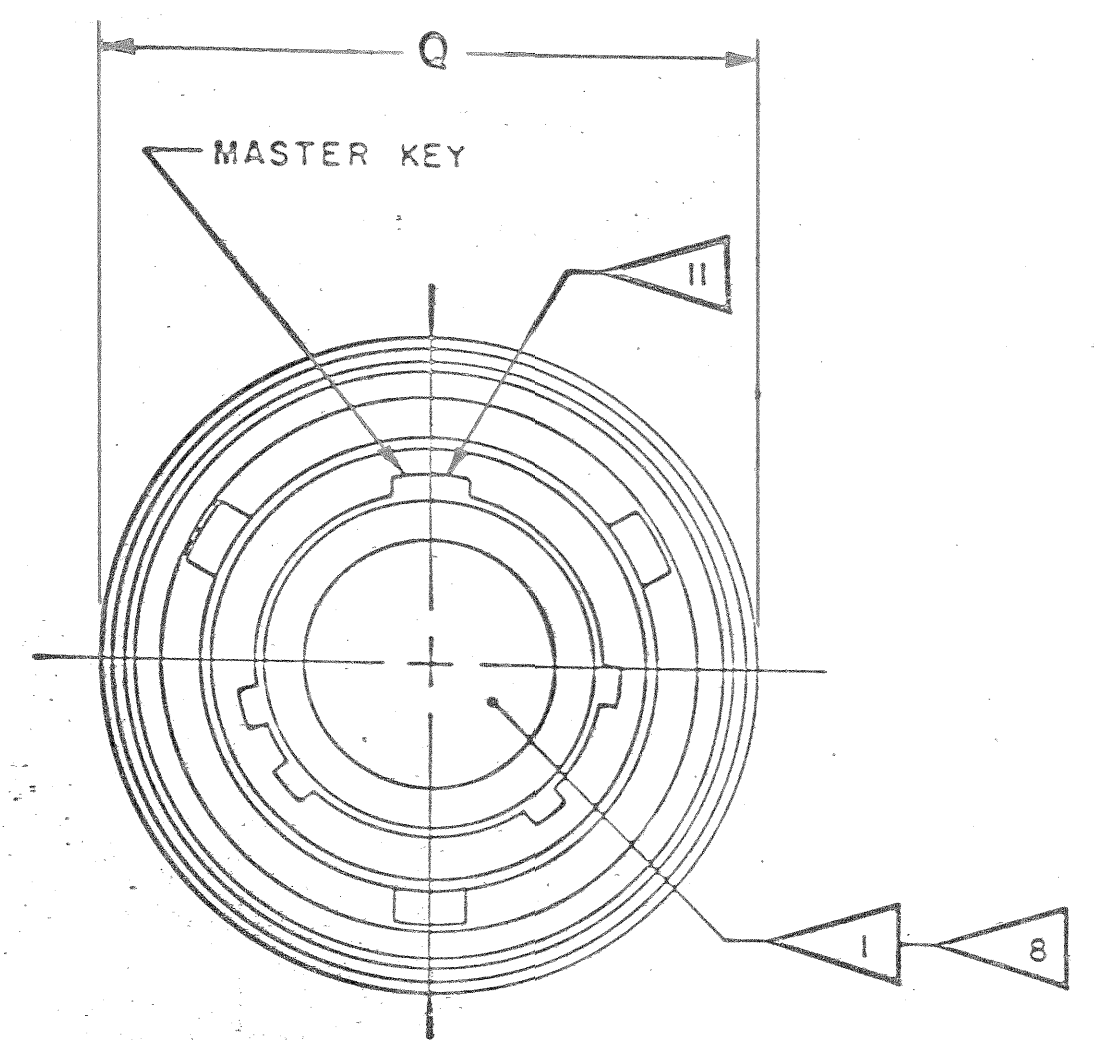

FIND NO.	QTY REQD	CODE IDENT	PART NUMBER	DESCRIPTION	NOTE REF
6	SEE PARTS LIST		10-452952	INSULATOR	
5	SEE NOTE 5		SEE PARTS LIST	COAX CONTACT, PIN & SOCKET	
			SEE PARTS LIST	CONTACT, PIN	9
			SEE PARTS LIST	CONTACT, SOCKET	9
4	1		10-462997-XX	COUPLING NUT	
3	1		SEE COLUMN	SNAP RING	
2	SEE COL.		SEE COLUMN	WASHER, WAVED	
1	1		SEE COLUMN	SHELL & INSERT ASSY	

UNLESS OTHERWISE SPECIFIED		SIGNATURES		DATES		The Bendix Corporation Electrical Components Division Sidney, New York	
LINEAR DIMENSIONS ARE IN INCHES. TOLERANCES: .XXX ± .010, .XX ± .03, .X ± .1, ANGLES ± 2°. OTHER STANDARDS PER 9-3800 AND MIL-D-1000. NOTE REF		PREPARED	R. C. GOULD	9-28-72			TITLE: CONNECTOR, ELECTRICAL PLUG; TYPE LJT-RT(M)C, GPC, STAINLESS STEEL
		CHECKED	<i>[Signature]</i>	9-5-75			
		MATERIAL					
		APPROVED	<i>[Signature]</i>	9/4/75			
		APPROVED	<i>[Signature]</i>	9/5/75			
MATERIAL SPEC	PROCESS SPEC						
	SEE NOTE 14						
		SIZE	CODE IDENT NO.	10-525545 THRU 10-525559			
		C	77820				
		SCALE	NONE	SEE PARTS LIST	87/88-436045/59	SHEET 1 OF 2	

SEE SHEET 2
NOTES:
VIEW A
ENLARGED
FOR COAXIAL ONLY

4

3

2

1

ASSEMBLY NUMBER	LJT NUMBER	ASSEMBLY NUMBER	WASHER		SNAP RING	L MAX	Q DIA MAX	V THREAD CLASS 2A
			PART NUMBER	QTY				
10-525545-()	06RT- 7-() (155)	10-525560-()	NOT AVAILABLE					
10-525546-()	- 9-()	10-525561-()	10-251456-9	2	10-457194-88	1.219	.844	.4375-28 UNEF
10-525547-()	-11-()	10-525562-()		2	-108		.969	.5625-24
10-525548-()	-13-()	10-525563-()		1	-128		1.141	.6875-24
10-525549-()	-15-()	10-525564-()		1	10-405990-14		1.266	.8125-20
10-525550-()	-17-()	10-525565-()		1	-16		1.391	.9375-20
10-525551-()	-19-()	10-525566-()		1	-18		1.500	1.0625-18
10-525552-()	-21-()	10-525567-()		1	-20		1.625	1.1875-18
10-525553-()	-23-()	10-525568-()		1	-22		1.750	1.3125-18
10-525554-()	-25-()	10-525569-()		1	-24		1.875	1.4375-18
10-525555/59		10-525570/74	NOT AVAILABLE					

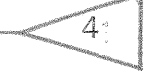
INSERT ARRANGEMENT SUFFIX 

WIRE WELL DATA						
CONTACT SIZE	22M	22D	22	20	16	12
WIRE WELL DATA	.028±.001	.0345±.0010	.0365±.0010	.047±.001	.067±.001	.100±.002
WIRE WELL DEPTH	.141 ^{+.016} _{-.000}	.141 ^{+.016} _{-.000}	.141 ^{+.016} _{-.000}	.209 ^{+.020} _{-.000}	.209 ^{+.020} _{-.000}	.209 ^{+.020} _{-.000}

COAXIAL DATA
SEE NOTE 1

- 10. PACKAGE PER PRODUCTION PROCESS SHEET.
- 9. FOR FINAL INSTALLATION, CONTACTS MUST BE ASSEMBLED INTO ALL INSERT HOLES. ALL UNUSED GROMMET HOLES MUST BE FILLED WITH THE APPROPRIATE SIZE SEALING PLUG 10-405996. CONTACTS ARE SHIPPED UNASSEMBLED.
- 8. INSERT ASSEMBLY IS NOT REMOVABLE.
- 7. DRAWING ILLUSTRATES FINAL ASSEMBLY.
- 6. DISTANCE FROM FLANGE TO THE POINT AT WHICH A GAGE PIN, HAVING THE SAME BASIC DIAMETER AS THE MATING CONTACT AND A SQUARE FACE ENGAGES SOCKET CONTACT.
- 5. SEE SEPARATE PARTS LIST FOR COMPONENT PART NUMBERS AND QUANTITIES.
- 4. TO COMPLETE ASSY NO., LJT NO. & SHELL & INSERT ASSY NO., ADD APPLICABLE INSERT ARRANGEMENT SUFFIX TO BASE NUMBERS LISTED ABOVE PER 9-2437-7.
- 3. FOR MATING RECEPTACLE ASSEMBLIES, SEE 10-525715/29 AND OTHERS.
- 2. SEE WORK ORDER FOR PERMISSIBLE ADDITIONAL OR ALTERNATE STAMPING.
- 1. FOR CONTACT ARRANGEMENT PATTERN, SEE DRAWING L-15206-() THRU L-15250-(). ALTERNATE POSITIONS THEREON DO NOT APPLY.
- 15. FOR SIZE 8 COAX., DIM IS .427±.025
- 14. PROCESS SPEC:
TEST 9-5044; ASSY 9-4407-3

9-5788, 9-2437-7
- 13. STAMP SMALL DASH IMMEDIATELY FOLLOWING THE WORD "BENDIX" PER 9-5788.
- 12. UNITS ILLUSTRATED MEET THE APPLICABLE REQUIREMENTS OF BSC-C19J.
- 11. MASTER KEY ROTATION IDENTIFICATION LETTER TO APPEAR ON INDICATED SURFACE EXCEPT FOR NORMAL KEY ROTATION.

SIZE C CODE IDENT NO. 77820 10-525545 THRU 10-525559

D

C

B

A

10-525545/59

JT/LJT specifications

CONTACT RATING

Contact Size	Test Current		Maximum Millivolt Drop Crimp*	Maximum Millivolt Drop	
	Solder & Crimp	Hermetic		Solder*	Hermetic*
22M	3	2	45	20	60
22D	5	3	73		85
22	5	3	73	20	85
20	7.5	5	55	20	60
16	13	10	49	20	85
12	23	17	42	20	85
10 (Power)	33	NA	33	NA	NA

Contact Size	Crimp Well Data		Solder Well Data	
	Well Diameter	Nominal Well Depth	Well Diameter	Nominal Well Depth
22M	.028 ±.001	.141	.029 ^{+.004} _{-.000}	
22D	.0345 ±.0010	.141		
22	.0365 ±.0010	.141	.036 ^{+.004} _{-.000}	.094
20	.047 ±.001	.209	.044 ^{+.004} _{-.004}	.125
16	.067 ±.001	.209	.078 ^{+.000} _{-.004}	.141
12	.100 ±.002	.209	.116 ^{+.004} _{-.002}	.141
10 (Power)	.137 ±.002	.355	NA	NA

* When tested using silver plated wire.

SERVICE RATING**

Service Rating	Suggested Operating Voltage (Sea Level)		Test Voltage (Sea Level)	Test Voltage 50,000 Ft.	Test Voltage 70,000 Ft.	Test Voltage 110,000 Ft.
	AC (RMS)	DC				
M	400	500	1300 VRMS	550 VRMS	350 VRMS	200 VRMS
N	300	450	1000 VRMS	400 VRMS	260 VRMS	200 VRMS
I	600	850	1800 VRMS	600 VRMS	400 VRMS	200 VRMS
II	900	1250	2300 VRMS	800 VRMS	500 VRMS	200 VRMS

** Please note that the establishment of electrical safety factors is left entirely in the designer's hands, since he is in the best position to know what peak voltage, switching surges, transients, etc. can be expected in a particular circuit.

FINISH DATA

Aluminum Shell Components Non-Hermetic				
Finish	Suffix		Indicated Finish Standard for JT Types Listed Below	Indicated Finish Standard for LJT Types Listed Below
	Military	Proprietary		
Cadmium Plated Nickel Base	MS (A)	-	JT/JTG/JTL/JTP	LJT/LJTP
Anodic Coating (Alumilite)	MS (C)	(005)	JTS/JTPS/JTLS	LJTPS/LJTS
Chromate Treated (Iridite 14-2)		(011)	JTN/JTPN/JTLN	LJTN/LJTPN
Olive Drab Cadmium Plate Nickel Base	MS (B)	(014)		
Electroless Nickel	MS (F)	(023)		

Hermetic Connectors				
Material/Finish	Suffix		Indicated Finish Standard for JT Types Listed Below	Indicated Finish Standard for LJT Types Listed Below
	Military	Proprietary		
Carbon Steel Shell Tin Plated Shell and Contacts			JT()H/JT()Y JTL()H/JTL()Y	LJT()Y/LJT()H
Carbon Steel Shell Tin Plated Shell and Gold Plated Contacts	MS (D)			
Stainless Steel Shell Gold Plated Contacts	MS (E)	(162)	JTS()Y JTLS()Y	LJTS()Y

JT/LJT

insert availability and identification, alternate positioning

JT	LJT	Solder	Crimp	Hermetics		Service Rating	Total Contacts	Contact Size							
				Class H	Class Y*			22D	22M	22	20	16	12	8 (Coax)	
8-2		P				M	2				2				
8-3		X	N/A	P	P	M	3				3				
	9-3	X													
8-6		X	X	P	P	M	6		6						
	9-6	X	X	P	P										
	9-7	X				M	7		7						
	9-22	X				I	2				2				
8-35			X	P	P	M	6	6							
	9-35		X	P	P										
8-44			X	P	P	M	4			4					
	9-44		X												
8-97		X				M	4		2		2				
8-98		S	X	P	P	I	3				3				
	9-98	X	X	P	P										
	11-2★		2	P**		I	2					2			
10-4			3			I	4				4				
	11-4	X	2												
10-5		X	X	P	P	I	5				5				
	11-5	X	2												
	11-6	S				I	6				6				
10-13		X	X	P	P	M	13		13						
	11-13	X	X	P	P										
10-35			X	P	P	M	13	13							
	11-35		X	P	P										
10-98		X	X	P/S	P	I	6				6				
	11-98	X	X	P	P										
10-99			X	P	P	I	7				7				
	11-99		P												
12-3		X	X	P	P	II	3					3			
	13-3		P												
12-4		X	X	P	P	I	4				4				
	13-4★	X	X	P/S	P										
12-8		X	X	P	P/S	I	8				8				
	13-8	X	X	P	P										
12-22			X	P	P	M	22		22						
	13-22	X	X	P/S	P										
12-35			X	P	P	M	22	22							
	13-35		X	P	P										
12-98		X	X	P/S	P	I	10				10				
	13-98	X	X	P/S	P										
14-4			2			I	4						4		
	15-4		3												
14-5		X	X	P	P	II	5					5			
	15-5★	X	X												
14-15		X	X	P/S	P	I	15				14	1			
	15-15	X	X	P/S	P										
14-18		X	X	P/S	P	I	18				18				
	15-18	X	X	P/S	P										
14-19		X	3			I	19				19				
	15-19		2												
14-35			X	P	P	M	37	37							
	15-35		X	P	P										
14-37		X	X	P	P	M	37		37						
	15-37	X	X	P	P										
14-68			2			I	8				8				
	15-68	X	3												
14-97			2	P	P	I	12				8	4			
	15-97	X	2	P	P										

JT MASTER KEY/KEYWAY ROTATION

AB ANGLE OF ROTATION (Degrees)					
Shell Size	Normal	A	B	C	D
8	100°	82°	-	-	118°
10	100°	86°	72°	128°	114°
12	100°	80°	68°	132°	120°
14	100°	79°	66°	134°	121°
16	100°	82°	70°	130°	118°
18	100°	82°	70°	130°	118°
20	100°	82°	70°	130°	118°
22	100°	85°	74°	126°	115°
24	100°	85°	74°	126°	115°

A plug with a given rotation letter will mate with a receptacle with the same rotation letter. The AB angle for a given connector is the same whether it contains pins or sockets. Only the master key/keyway rotates in the shell, and the insert always remains in the same position relative to the minor keys.

AB angles shown are viewed from the front face of the connector, a receptacle is shown below. The angles for the plug are exactly the same except the direction of rotation is opposite of that shown for the receptacle.

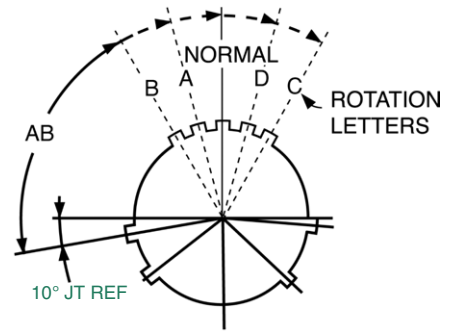

RELATIVE POSSIBLE POSITION OF ROTATED MASTER KEYWAY (front face of receptacle shown)

(P) Pin inserts only (consult Sidney, NY for socket availability)
 (S) Socket inserts only (consult Sidney, NY for pin availability)
 (2) Not tooled for RP or 02RE
 (3) Pin inserts only, not tooled for RP or 02RE (consult Sidney, NY for availability)

* Same as H with interfacial seal
 ** Tooled with special terminal only (consult Sidney, NY for availability of standard terminal)
 ★ Ground plane proprietary option available. See page 51 for further information on ground plane connectors.

JT/LJT

insert availability and identification, alternate positioning

JT	LJT	Solder	Crimp	Hermetics		Service Rating	Total Con-tacts	Contact Size								
				Class H	Class Y*			22D	22M	22	20	16	12	8 (Coax)	8 (Twinax)	
	17-2		2			M	39	38								1
16-6			X	P	P	I	6						6			
16-8		X	X	P	P	II	8					8				
16-13	17-8★	X	X	P	P/S											
	17-13		2			I	13						13			
	17-22					Coax	4						2 Coax	2		
	17-25		2			M	24	22						2		
16-26		X	X	P/S	P	I	26					26				
16-35	17-26	X	X	P/S	P											
	17-35	X	X	P/S	P	M	55	55								
16-42	17-35	X	X	P	P											
	17-42		P			M	42			42						
16-55		X	X	P/S	P	M	55		55							
	17-55	X	X	P		M	55		55							
16-99		X	X	P	P	I	23				21	2				
	17-99	X	X	S												
18-11		X	X	P	P	II	11					11				
	19-11★	X	X	P	P											
	19-18		2			M	18	14								4
18-28		X	X	P	P	I	28				26	2				
	19-28	X	P													
18-30		X	X			I	30				29	1				
	19-30	X	P													
18-32		X	X	P/S	P	I	32				32					
	19-32	X	X	P/S	P											
18-35		X	X	P	P	M	66	66								
	19-35	X	X	P	P											
18-53		X	X			M	53			53						
	19-53		P													
18-66		X	X	P	P	M	66		66							
	19-66	X	X	P	P											
	19-67	X	3	S		M	67		67							
18-68			2			I	18					18				
	19-68		3													
18-96			2			I	9						9			
20-1			X	P		M	79		79							
	21-1		X	S												
20-2			X			M	65			65						
	21-2		2													
20-11			3			I	11						11			
	21-11★		2													
20-16		X	X	P	P	II	16					16				
	21-16★	X	X	P	P											
	21-24	X				I	24					24				
	21-25	X				I	25					25				
	21-27	X				I	27					27				
20-35			X			M	79	79								
	21-35		X													
20-39		X	X	P	P	I	39				37	2				
	21-39	X	X	P	P											
20-41		X	X	P	P	I	41				41					
	21-41	X	X	S												

LJT MASTER KEY/KEYWAY ROTATION

AB ANGLE OF ROTATION (Degrees)					
Shell Size	Normal	A	B	C	D
9	95°	77°	-	-	113°
11	95°	81°	67°	123°	109°
13	95°	75°	63°	127°	115°
15	95°	74°	61°	129°	116°
17	95°	77°	65°	125°	113°
19	95°	77°	65°	125°	113°
21	95°	77°	65°	125°	113°
23	95°	80°	69°	121°	110°
25	95°	80°	69°	121°	110°

A plug with a given rotation letter will mate with a receptacle with the same rotation letter. The AB angle for a given connector is the same whether it contains pins or sockets. Only the master key/keyway rotates in the shell, and the insert always remains in the same position relative to the minor keys.

AB angles shown are viewed from the front face of the connector, a receptacle is shown below. The angles for the plug are exactly the same except the direction of rotation is opposite of that shown for the receptacle.

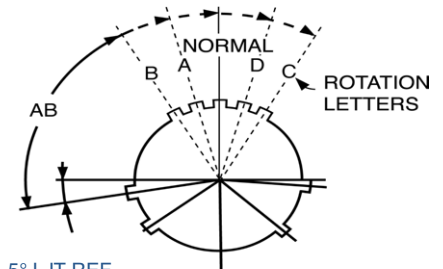

5° LJT REF

RELATIVE POSSIBLE POSITION OF ROTATED MASTER KEYWAY (front face of receptacle shown)

(P) Pin inserts only (consult Sidney, NY for socket availability)
 (S) Socket inserts only (consult Sidney, NY for pin availability)
 (2) Not tooled for RP or 02RE

(3) Pin inserts only, not tooled for RP or 02RE (consult Sidney, NY for availability)
 * Same as H with interfacial seal
 ★ Ground plane proprietary option available. See page 51 for further information on ground plane connectors.

insert availability and identification

JT	LJT	Solder	Crimp	Hermetics		Service Rating	Total Contacts	Contact Size									
				Class H	Class Y*			22D	22M	22	20	16	12	8 (Coax)	8†† (Twinax)	10 (Power)	12 Coax
	21-75★		2			N	4								(See Note 4)		
	21-79		2			II	19	17							(See Note 5)		
22-1			X			M	100		100								
	23-1		X														
22-2		X	X	P	P	M	85			85							
	23-2	X	X	P	P												
	23-5		X			M	5								5		
	23-6★		P			M	6								6		
22-14			2			I	14						14				
	23-14		2														
22-21		X	X	P	P	II	21					21					
	23-21★	X	X	P	P												
22-32		X	X	P		I	32				32						
	23-32	X	P														
	23-34	X				I	34				34						
22-35			X			M	100	100									
	23-35		X														
	23-36	X				I	36				36						
22-53			P			I	53				53						
	23-53	X	X	P/S													
22-55		X	X	P	P	I	55				55						
	23-55		3														
	23-97	X				II	16										
	23-99	X				II	11						11				
24-1			X			M	128		128								
	25-1		X														
24-2			X			M	100			100							
	25-2		X														
24-4			X	P	P	I	56				48	8					
	25-4		X														
	25-7		2			M	99	97							2		
	25-11		2			N	11				2					9	
24-19			2			I	19						19				
	25-19★		2														
	25-20		2			N	30			10	13**			3		4	
24-24			X	P	P	I	24				12	12					
	25-24★		X														
24-29			X			I	29					29					
	25-29★	X	X														
24-35			X			M	128	128									
	25-35		X														
24-37			2			I	37					37					
	25-37★		2														
24-43			3			I	43			23	20						
	25-43	X	2	P	P												
	25-46		2			I	46			40	4			2†			
24-61		X	X	P	P	I	61			61							
	25-61	X	X	P	P												

(P) Pin inserts only (consult Sidney, NY for socket availability)
 (S) Socket inserts only (consult Sidney, NY for pin availability)
 (2) Not tooled for RP or 02RE
 (3) Pin inserts only, not tooled for RP or 02RE (consult Sidney, NY for availability)
 * Same as H with interfacial seal
 ** Two size 16 contacts dedicated to fiber optics. Consult Sidney, NY or catalog section 12-352 for fiber optic contact information.
 † For RG180/U and RG195/U cables only (consult Sidney, NY for other cable applications)

†† Size 8 Coax and Twinax are interchangeable
 (4) MS connector 21-75 is supplied with four size 8 twinax contacts. Proprietary connector 21-75 is supplied with four size 8 coax contacts.
 (5) MS connector 21-79 has provision for two size 8 coax contacts. Coax contacts are not supplied unless specified by customer.
 ★ Ground plane proprietary option available. See page 51 for further information on ground plane connectors.

JT/LJT

insert arrangements

black arrangements – JT or LJT
 green arrangements – JT only
 blue arrangements – LJT only

front face of pin inserts illustrated

Insert Arrangement (JT)	8-2	8-3	8-6			8-35	8-44	8-97	8-98
Insert Arrangement (LJT)		9-3	9-6	9-7	9-22	9-35	9-44		9-98
Service Rating	M	M	M	M	I	M	M	M	I
Number of Contacts	2	3	6	7	2	6	4	2 2	3
Contact Size	20	20	22M	22M	20	22D	22	22M 20	20

Insert Arrangement (JT)		10-4	10-5		10-13	10-35	10-98	10-99
Insert Arrangement (LJT)	11-2	11-4	11-5	11-6	11-13	11-35	11-98	11-99
Service Rating	I	I	I	I	M	M	I	I
Number of Contacts	2	4	5	6	13	13	6	7
Contact Size	16	20	20	20	22M	22D	20	20

Insert Arrangement (JT)	12-3	12-4	12-8	12-22	12-35	12-98	14-4	14-5
Insert Arrangement (LJT)	13-3	13-4	13-8	13-22	13-35	13-98	15-4	15-5
Service Rating	II	I	I	M	M	I	I	II
Number of Contacts	3	4	8	22	22	10	4	5
Contact Size	16	16	20	22M	22D	20	12	16

Insert Arrangement (JT)	14-15	14-18	14-19	14-35	14-37	14-68	14-97
Insert Arrangement (LJT)	15-15	15-18	15-19	15-35	15-37	15-68	15-97
Service Rating	I	I	I	M	M	I	I
Number of Contacts	14 1	18	19	37	37	8	8 4
Contact Size	20 16	20	20	22D	22M	16	20 16



JT/LJT

insert arrangements

black arrangements – JT or LJT
 green arrangements – JT only
 blue arrangements – LJT only

front face of pin inserts illustrated

Insert Arrangement (JT)		16-6	16-8	16-13			16-26
Insert Arrangement (LJT)	17-2	17-6	17-8	17-13	17-22	17-25	17-26
Service Rating	M	I	II	I	Coax	M	I
Number of Contacts	38 1	6	8	13	2 2	22 2	26
Contact Size	22D 8 Twinax	12	16	16	12 Coax 8 Coax	22D 8 Coax	20

Insert Arrangement (JT)	16-35	16-42	16-55	16-99	18-11	19-18
Insert Arrangement (LJT)	17-35	17-42	17-55	17-99	19-11	19-18
Service Rating	M	M	M	I	II	M
Number of Contacts	55	42	55	21 2	11	14 4
Contact Size	22D	22	22M	20 16	16	22D 8 Twinax

Insert Arrangement (JT)	18-28	18-30	18-32	18-35	18-53	18-66
Insert Arrangement (LJT)	19-28	19-30	19-32	19-35	19-53	19-66
Service Rating	I	I	I	M	M	M
Number of Contacts	26 2	29 1	32	66	53	66
Contact Size	20 16	20 16	20	22D	22	22M

Insert Arrangement (JT)		18-68	18-96	20-1	20-2
Insert Arrangement (LJT)	19-67	19-68		21-1	21-2
Service Rating	M	I	I	M	M
Number of Contacts	67	18	9	79	65
Contact Size	22M	16	12	22M	22



JT/LJT

insert arrangements

black arrangements – JT or LJT
 green arrangements – JT only
 blue arrangements – LJT only

front face of pin inserts illustrated

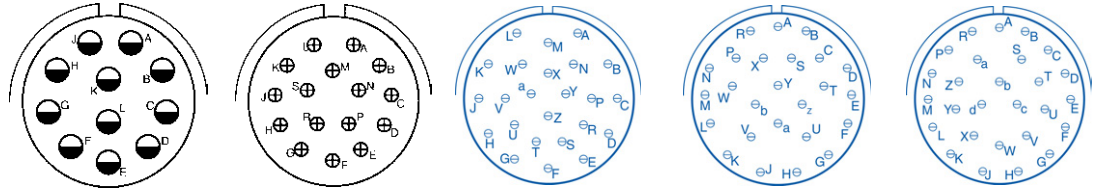

Insert Arrangement (JT)	20-11	20-16	21-24	21-25	21-27
Insert Arrangement (LJT)	21-11	21-16	21-24	21-25	21-27
Service Rating	I	II	I	I	I
Number of Contacts	11	16	24	25	27
Contact Size	12	16	20	20	20

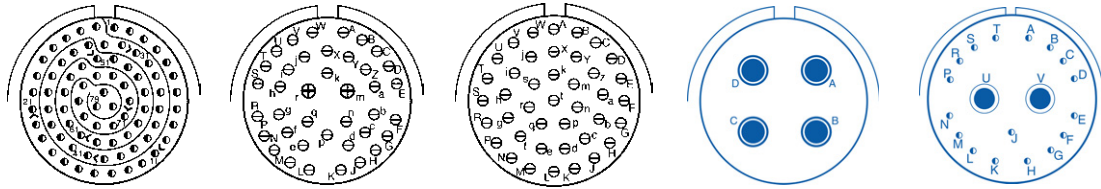

Insert Arrangement (JT)	20-35	20-39	20-41	21-75	21-79
Insert Arrangement (LJT)	21-35	21-39	21-41	21-75	21-79
Service Rating	M	I	I	N	II
Number of Contacts	79	37 2	41	4	17 (See Note)
Contact Size	22D	20 16	20	(See Note)	22D

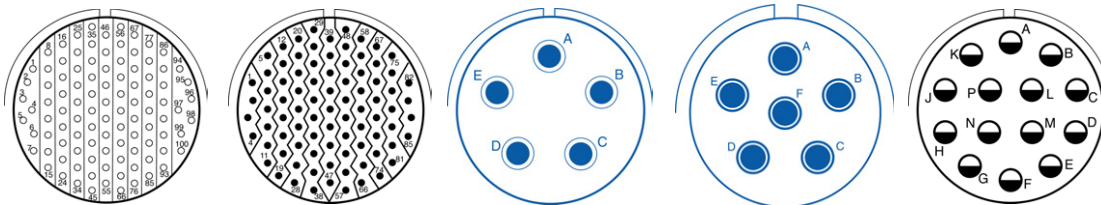

Insert Arrangement	22-1	22-2	23-5	23-6	22-14
Insert Arrangement (LJT)	23-1	23-2	23-5	23-6	23-14
Service Rating	M	M	M	M	I
Number of Contacts	100	85	5	6	14
Contact Size	22M	22	8 Twinax	8 Twinax	12

Note: MS connector 21-75 is supplied with four size 8 twinax contacts.
 Proprietary connector 21-75 is supplied with four size 8 coax contacts.
 MS connector 21-79 has provision for two size 8 coax contacts.
 Coax contacts are not supplied unless specified by customer.



JT/LJT

insert arrangements

black arrangements – JT or LJT
 green arrangements – JT only
 blue arrangements – LJT only

front face of pin inserts illustrated

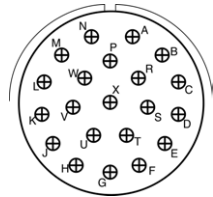

22-21



22-32

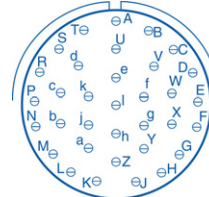

23-34

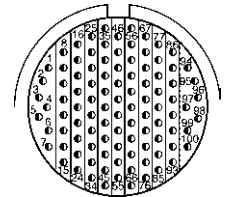

22-35

Insert Arrangement (JT)
Insert Arrangement (LJT)
Service Rating
Number of Contacts
Contact Size

23-21
II
21
16

23-32
I
32
20

I
34
20

23-35
M
100
22D

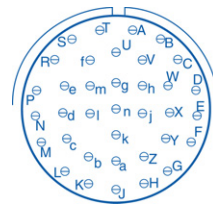

23-36

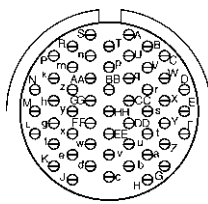

22-53

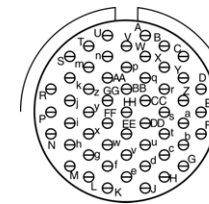

22-55

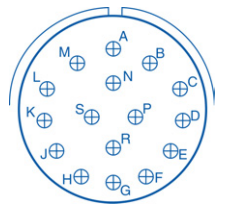

23-97

Insert Arrangement (JT)
Insert Arrangement (LJT)
Service Rating
Number of Contacts
Contact Size

I
36
20

I
53
20

I
55
20

II
16
16

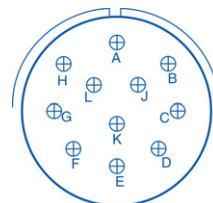

23-99

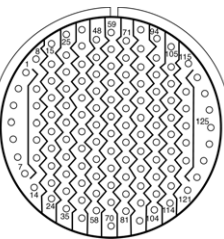

24-1

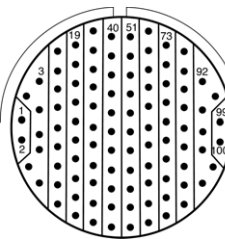

24-2

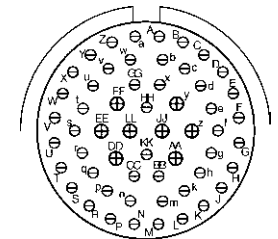

24-4

Insert Arrangement (JT)
Insert Arrangement (LJT)
Service Rating
Number of Contacts
Contact Size

II
11
16

M
128
22M

M
100
22

I
48 8
20 16



JT/LJT

insert arrangements

black arrangements – JT or LJT
 green arrangements – JT only
 blue arrangements – LJT only

front face of pin inserts illustrated

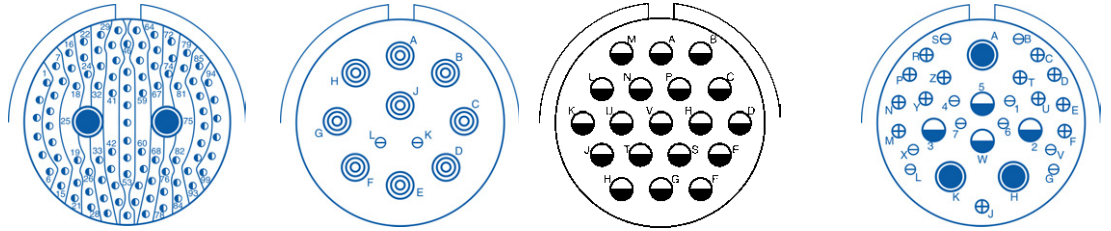

Insert Arrangement (JT)

Insert Arrangement (LJT)

Service Rating

Number of Contacts

Contact Size

25-7
 M
 97 2
 22D 8 Twinax

25-11
 N
 2 9
 20 10

24-19

25-19

I

19

12

25-20

N

10 13 3 4

20 16 8 Twinax 12 Coax

(Locations U and Y - Dedicated to Fiber Optics)

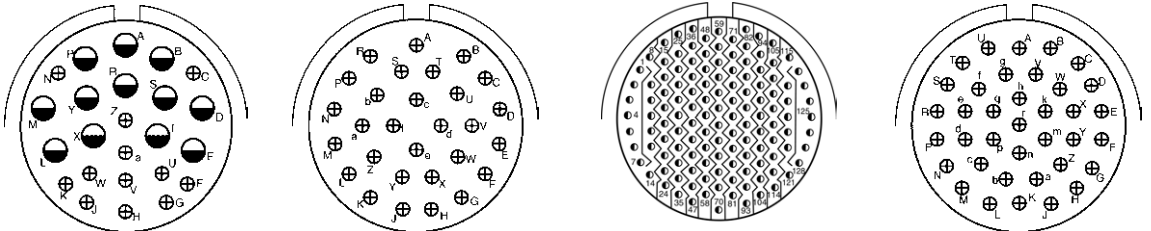

Insert Arrangement (JT)

Insert Arrangement (LJT)

Service Rating

Number of Contacts

Contact Size

24-24
 25-24
 I
 12 12
 16 12

24-29
 25-29
 I
 29
 16

24-35
 25-35
 M
 128
 22D

24-37
 25-37
 I
 37
 16

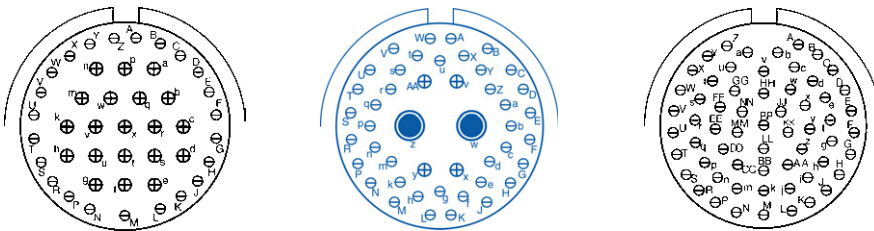

Insert Arrangement (JT)

Insert Arrangement (LJT)

Service Rating

Number of Contacts

Contact Size

24-43
 25-43
 I
 23 20
 20 16

25-46
 I
 40 4 2
 20 16 8 Coax†

24-61
 25-61
 I
 61
 20

† Coax contacts for RG180 or RG195 cable.

JT/LJT — accessories

strain relief (crimp type)

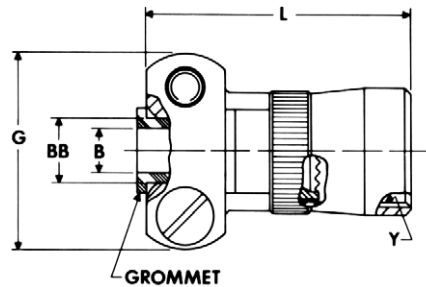

***10-405982-XXX (MS27506XXX-2 or M85049/49)**

For MS stamping identification, accessories must be ordered by MS part number.
If ordered by 10-part number, they will be stamped with said number.

*To complete order number, add shell size and suffix number.

Finish	10-Number Suffix	MS27506 Suffix	M85049/49 Suffix
Chromate treat	-XX0		NA
Anodic coating	-XX5	CXX-2	(-2-XXA)
Cadmium plate nickel base	-XX7	AXX-2	NA
Olive drab, cadmium, nickel base	-XX9	BXX-2	(-2-XXW)
Electroless nickel	-XXG	FXX-2	(-2-XXN)

For example: Shell size 10 with cadmium plate, nickel base would be 10-405982-107
or M85049/49-2-10W

Shell Size	B Dia +.010 -.025	G Max.	L Max	Y Thread (Modified)		BB Dia. +.000 -.011	Screw Size
				Size Class 2B	Modified Minor Dia.		
8	.125	.775	.984	.4375-28UNEF	.399 - .405	.250	6-32UNC
10	.188	.837	.984	.5625-24UNEF	.524 - .529	.312	6-32UNC
12	.312	.963	.984	.6875-24UNEF	.649 - .654	.438	6-32UNC
14	.375	1.087	1.234	.8125-20UNEF	.766 - .771	.562	6-32UNC
16	.500	1.150	1.234	.9375-20UNEF	.891 - .896	.625	6-32UNC
18	.625	1.400	1.234	1.0625-18UNEF	1.002 - 1.007	.750	8-32UNC
20	.625	1.400	1.234	1.1875-18UNEF	1.135 - 1.140	.750	8-32UNC
22	.750	1.587	1.359	1.3125-18UNEF	1.252 - 1.257	.938	8-32UNC
24	.800	1.681	1.281	1.4375-18UNEF	1.377 - 1.382	1.000	8-32UNC

All dimensions for reference only.

Note: For solder type cable clamp 10-241055-XXX (M85049/49) consult Amphenol, Sidney, NY.

For other M85049 accessories available from Amphenol Aerospace, see page 46.

LJT — accessories

plug protection cap

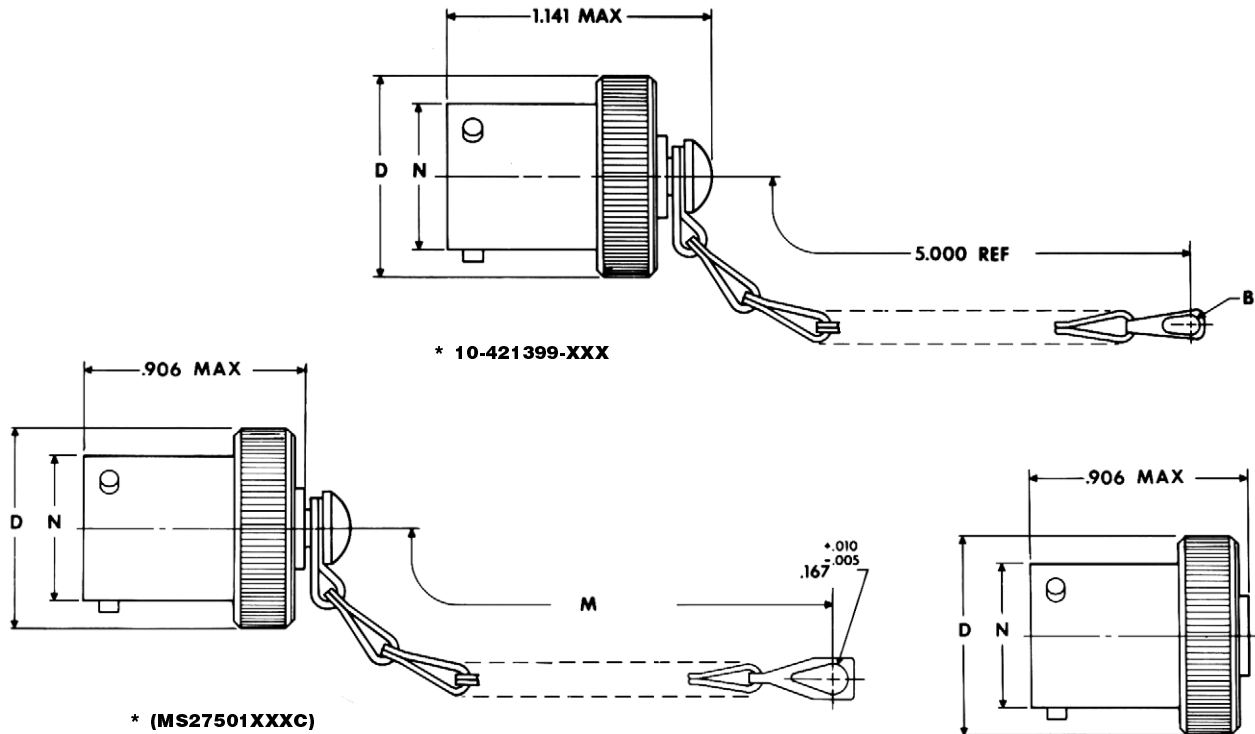

* 10-421399-XXX

* (MS27501-XXX)

* 10-275196-XXX (MS27501)

* To complete order number, add shell size and suffix number.
 For example, shell size 11 with cadmium plate, nickel base would be 10-421399-117, MS27501A11C or MS20048A11.

Shell Size	B Dia. Ref.	D Dia. Max.	M ±.250	N Dia. +.001 - .005
9	.180	.812	3.000	.572
11	.180	.938	3.000	.700
13	.180	1.062	3.500	.850
15	.180	1.188	3.500	.975
17	.180	1.312	3.500	1.100
19	.209	1.438	3.500	1.207
21	.209	1.562	4.000	1.332
23	.209	1.688	4.000	1.457
25	.209	1.812	4.000	1.582

Finish	10-Number Suffix	MS Number Suffix with chain	MS Number Suffix without chain
Chromate treat	-XX0		
Anodic coating	-XX5		
Cadmium plate nickel base	-XX7	AXXC	AXX
Olive drab, cadmium, nickel base	-XX9	BXXC	BXX
Electroless nickel	-XXG	FXXC	FXX

All dimensions for reference only.

JT/LJT — thermocouple contacts, plastic protection caps, sealing plugs

THERMOCOUPLE CONTACTS

Contact Size	Material	JT/LJT Pins	JT Sockets	LJT Sockets
20	Chromel	10-407862-310	10-407863-310	10-407236-310
	Alumel	10-407862-320	10-407863-320	10-407865-320
	Iron	10-407862-335	10-407863-335	10-407865-335
	Constantan	10-407862-342	10-407863-342	10-407865-342

Partial listing. If you do not see the contact for your application, consult Amphenol, Sidney, NY.

PLASTIC PROTECTION CAPS

JT	LJT	Plug	Receptacle
8		10-70500-10	10-70506-10S
	9	10-70506-14	10-70500-10
10		10-70506-14	10-70506-12
	11	10-70506-16	10-70500-12
12		10-70506-16	10-70506-14
	13	10-70506-18	10-70500-14
14		10-70506-18	10-70506-16
	15	10-70506-20	10-70500-16
16		10-70506-20	10-70506-18
	17	10-70506-22	10-70500-18
18		10-70506-22	10-70506-20
	19	10-70506-24	10-70500-20
20		10-70506-24	10-70506-22
	21	10-70576-24	10-70500-22
22		10-70576-24	10-70506-24
	23	10-70506-28	10-70500-24
24		10-70506-28	10-70576-24
	25	10-558651-25	10-70506-28

SEALING PLUGS

Contact Size	Sealing Plugs	
	Proprietary No.	MS No.
8 (Coax)	10-482099-8	MS27488-8
8 (Twinax)	T3-4008-59P	N/A
10 (Power)	10-576225	N/A
12	10-405996-12	MS27488-12
16	10-405996-16	MS27488-16
20	10-405996-20	MS27488-20
22	10-405996-22	MS27488-22
22M	10-405996-22	MS27488-22
22D	10-405996-22	MS27488-22

JT/LJT — accessories

M85049 strain reliefs, adapters, backshells, “ABK” heat shrinkable backshells



MIL-C-85049 Accessories

MIL-C-85049 Accessories

Now available through Amphenol are:

- Strain Reliefs (self-locking, nonself-locking, clamps & tie mounts)
- Shrink boat adapters (environmental and non-environmental)
- Backshells (environmental and non-environmental)

Part numbers covered are: M85049/14, /15, /16, /17, /18, /19, /20, /21, /27, /33, /36, /37, /38, /39, /47, /49-2, /57, /62, /63, /69.

Consult Amphenol Aerospace, Sidney, NY for further information.



“ABK” Heat Shrinkable Backshells

“ABK” Heat Shrinkable Backshells – One Part Cable Termination for MIL-C-38999 Series I, II, III & IV

Benefits of “ABK” assemblies are:

- One piece part
- Quick and easy installation
- One part covers wide cable range
- Lightweight
- Stainless and aluminum adapters
- F, W and C Class finishes
- Shielded and Unshielded
- Straight, 45° and 90° configurations
- Various material, i.e. LFH, fluid resistant
- Operating temp. range – 55°C to +150°C
- Repairable

Amphenol “ABK” Heat Shrinkable backshell kits are one-part assemblies for terminating MIL-C-38999 Series I, II, III & IV connectors to either shielded or unshielded cables. Constructed using Spin Coupling adapters and heat-shrinkable molded parts, the kit comprises components already well proven in harsh military environments.

Installation is simply effected by coupling the adapter to the connector and shrinking the rear of the molded part onto the cable with a hot air gun. The molded part has a hot melt adhesive pre-installed to provide a bond between the cable jacket and the molded part. When used in conjunction with shielded cables, the assembly provides electrical continuity between the cable shield and the connector with Rayaten™ molded parts which provide screening levels better than 90 DB at 100 MHz.

For more information on “ABK” backshells, including how to order and cable ranges, consult Amphenol Aerospace, Sidney, NY.

JT/LJT application tools

The following data includes information pertaining to the application tools which have been established for crimping, inserting, and removing the size 12, 16, 20, 22, 22D and 22M contacts incorporated in the JT-R, LJT-R and MIL-C-38999 (MS) series connectors as applicable.

All crimping tools included are the “full cycling” type and when used as specified in the installation instructions (L-624 and L-844 cover-

ing the JT-R, LJT-R and MS series connectors will provide reliable crimped wire to contact terminations. There is a possibility of additional crimping tools other than those included being available at present or in the future for this specific application.

For additional information on coaxial contacts, consult Amphenol® catalog section 12-130.

CRIMPING TOOLS

Contact Size/Type	Crimping Tool	Turret Die or Positioner
12 Pin and Socket	M22520/1-01	M22520/1-04
16 Pin and Socket	M22520/1-01 M22520/7-01	M22520/1-04 M22520/7-04
20 Pin and Socket	M22520/1-01 M22520/2-01 M22520/7-01	M22520/1-04 M22520/2-10 M22520/7-08
22, 22D, 22M Pin	M22520/2-01 M22520/7-01	M22520/2-09 M22520/7-07
22, 22D, 22M Socket (LJT-R)	M22520/2-01 M22520/7-01	M22520/2-07 M22520/7-05
22D Socket (JT-R)	M22520/2-01 M22520/7-01	M22520/2-06 M22520/7-06
8 Twinax Center Pin and Socket	M22520/2-01	M22520/2-37
8 Twinax Intermediate Outer Pin & Socket	M22520/5-01	M22520/5-200

Contact Size/Type	Crimping Tool	Turret Die or Positioner
8 Coaxial Inner Pin and Socket	M22520/2-01	M22520/2-31
8 Coaxial Outer Pin and Socket	M22520/5-01	M22520/5-05 Die Closure B
	M22520/5-01	M22520/5-41 Die Closure B
	M22520/10-01	M22520/10-07 Die Closure B
16 Coaxial Inner Pin and Socket	M22520/2-01	M22520/2-35
16 Coaxial Outer Pin and Socket	M22520/4-01	M22520/4-02
12 Coaxial Inner Pin and Socket	M22520/2-01	M22520/2-34
12 Coaxial Outer Pin and Socket	M22520/31-01	M22520/31-02
10 (Power)	††	††

Where 2 or 3 tools are listed for a contact size, only one tool and its die or positioner are required to crimp the contact. The above crimping tools and positioners are available from the approved tool manufacturer.

INSERTION TOOLS

Use with Contact Size	Plastic Tools		Metal Tools			
	Part Number	Color Code	Angle Type		Straight Type Proprietary Part Number	Color Code
			MS Part Number	Proprietary Part Number		
10 (Power)	M81969/14-05*	Gray/White	M81969/8-11	†	†	Green
12	M81969/14-04*	Yellow/(White)	M81969/8-09	11-8674-12	11-8794-12	Yellow
16	M81969/14-03*	Blue/(White)	M81969/8-07	11-8674-16	11-8794-16	Blue
20	M81969/14-10*	Red/(Orange)	M81969/8-05	11-8674-20	11-8794-20	Red
22	M81969/14-09	Brown/(White)	M81969/8-03	11-8674-22	11-8794-22	Brown
22D, 22M	M81969/14-01*	Green/(White)	M81969/8-01	11-8674-24	11-8794-24	Black
8 Coaxial	None Required					
8 Twinax	None		M81969/46-06**	None		Red

REMOVAL TOOLS

Use with Contact Size	Plastic Tools		Metal Tools				
	Part Number	Color Code	For Unwired Contacts Proprietary Part Number	Angle Type		Straight Type Proprietary Part Number	Color Code
				MS Part Number	Proprietary Part Number		
10 (Power)	M81969/14-05*	(Green)/White	†	M81969/8-12	†	†	Green/White
12	M81969/14-04*	(Yellow)/White	11-10050-11	M81969/8-10	11-8675-12	11-8795-12	Yellow/White
16	M81969/14-03*	(Blue)/White	11-10050-10	M81969/8-08	11-8675-16	11-8795-16	Blue/White
20	M81969/14-10*	(Red)/Orange	11-10050-9	M81969/8-06	11-8675-20	11-8795-20	Red/White
22	M81969/14-09*	(Brown)/White	11-10050-8	M81969/8-04	11-8675-22	11-8795-22	Brown/White
22D, 22M	M81969/14-01*	(Green)/White	11-10050-7	M81969/8-02	11-8675-24	11-8795-24	Black/White
8 Coaxial	M81969/14-12	Green	None	None	11-9170	DRK264-8††	N/A
8 Twinax	M81969/14-12	Green	None	M81969/46-12**	11-9170	N/A	N/A

The M81969/8, 11-8674, 11-8675, and 11-8794 metal contact insertion and removal tools will accommodate wires having the maximum outside diameter as follows: Contact size 12– .155, 16– .109, 20– .077, 22, 22D, 22M– .050. When wire diameters exceed those specified, the plastic tools must be used.

* Double ended insertion/removal tool.

** Twinax insertion and removal tools are available only in a straight type, metal version.

† To be determined

†† Contact Daniels Manufacturing Co. for availability.

JT/LJT

how to order

PROPRIETARY PART NUMBER

To more easily illustrate ordering procedure, part number JT00RE-22-2PA () is shown as follows:

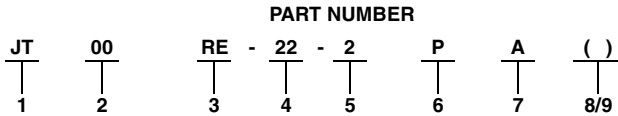

See code below:

1. Connector Type:

- JT** designates standard Junior Tri-Lock connector
- LJT** designates long Junior Tri-Lock connector
- LJTS** **JTS** designates high temperature connector
- LJTN** **JTN** designates chemical and fuel resistant
- JTL** designates miniature mounting dimensions
- JTLN** designates miniature mounting dimensions - chemical resistant
- JTLS** designates miniature mounting dimensions - high temperature
- LJTPQ** **JTPQ** designates back panel mounted wall mounting receptacle
- LJTP** **JTP** designates back panel mounted box mounting receptacle
- LJTPN** **JTPN** designates back panel mounted - chemical resistant
- LJTSP** **JTSP** designates back panel mounted - high temperature
- JTG** designates plug with grounding fingers*
- JTNG** designates plug with grounding fingers* - chemical resistant

2. Shell Style:

- 00** designates wall mount receptacle
- 01** designates line mount receptacle
- 02** designates box mount receptacle
- 06** designates straight plug
- 07** designates jam nut receptacle
- 08** designates 90 degree plug
- I** designates solder mount receptacle - hermetic

3. Service Class: Solder contacts/connectors:

- "P" for potting applications - These connectors are supplied with a potting boot.† All shells are designed with integral features to retain potting boots.
- "A" for general duty applications.
- "A (SR)" - threaded rear design with strain relief.†
- "C" for pressurized applications.
- "C" (SR) - threaded rear design with strain relief.†
- "H" for hermetic applications - Fused compression glass sealed inserts. Leakage rate less than .01 micron cu. ft./hr. (1 x 10⁻⁷ cc/sec.) at 15 psi differential.
- "Y" same as "H" with interfacial seal.
- "T" for MS27599A applications - general duty, pressurized (receptacles only)

3. Service Class: Crimp contacts/connectors:

- "RP" for potting crimp applications. Supplied with spacer grommet and potting boot.†
- "RE" for environmental crimp applications. Supplied with a grommet and compression nut.† Can be supplied with strain relief integral with compression nut "RE (SR)". (JT Series only).
- "RGF"*** electroless nickel plated ground plane aluminum, 200°C
- "RGW"*** olive drab cadmium plated ground plane aluminum, 175°C
- "RT" for environmental applications. Supplied without rear accessories. Design provides serrations on rear threads of shells.

For additional information defining description of service class, consult Amphenol, Sidney, NY.

4. Shell Size:

- JT shell sizes available from 8 through 24.
- LJT shell sizes available from 9 through 25.

5. Insert Arrangement:

- 22-2 designates insert arrangement. Refer to pages 4-9 for insert availability.

6. Contact Style:

- P designates pin contacts; S designates socket contacts.

7. Alternate Keying:

- "A" designates alternate keying connector assembly. Other basic alternate keys are "B", "C" and "D". No letter required for normal (no rotation) position. See pages 4 and 5.

8. Strain Relief Option:

- "SR" designates a strain relief clamp. Strain reliefs are available only on "A", "C" and "RE" class connectors.

9. Finish Variation Suffix:

See finish variations available in table below:

Finish	Military Finish Data	Finish Suffix	Finish plus "SR" Suffix
Cadmium plated nickel base	A		(SR)
Olive drab cadmium plate nickel base	B	(014)	(386)
Electroless nickel	F	(023)	(424)
Electroless nickel, space compatible		(453)	(467)
Anodic coating (Alumilite)	C	(005)	(300)
Chromate treated (Iridite 14-2)		(011)	(344)

MILITARY TYPES

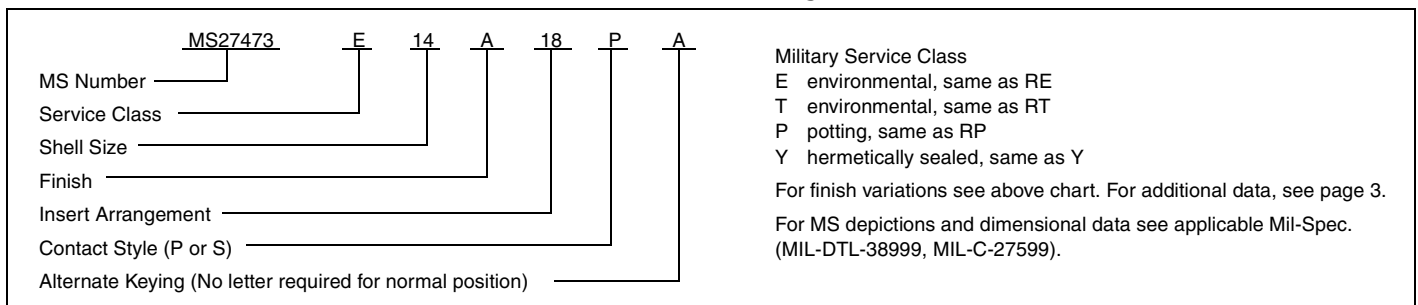

* Grounding fingers standard on all LJT plugs
 † Not applicable to box mounting style or LJT Series I.
 ** For more information on Coax/Triax/Twinax Ground Plane Connectors, see page 51.