



UTD405

Power MOSFET

P-CHANNEL ENHANCEMENT MODE

DESCRIPTION

The **UTD405** can provide excellent $R_{DS(ON)}$, low gate charge and low gate resistance by using advanced trench technology. This device is well suited for high current load applications with the excellent thermal resistance.

FEATURES

- * $R_{DS(ON)} = 32m\Omega @ V_{GS} = -10 V$
- * Low capacitance
- * Low gate charge
- * Fast switching capability
- * Avalanche energy specified

SYMBOL

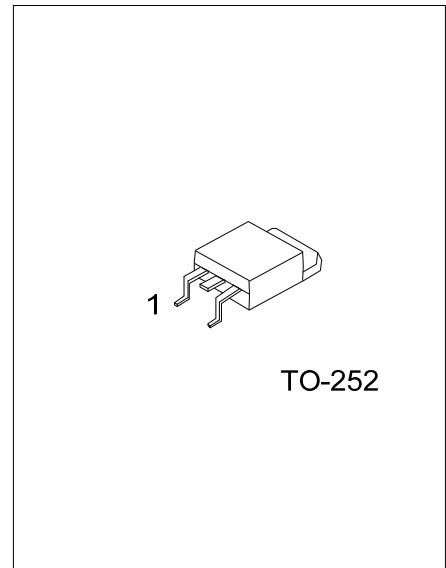
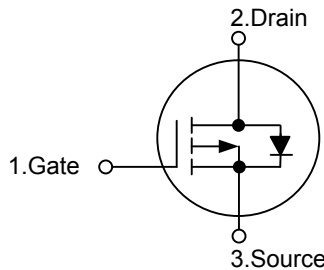

*Pb-free plating product number: UTD405L

ORDERING INFORMATION

Ordering Number		Package	Pin Assignment			Packing
Normal	Lead Free Plating		1	2	3	
UTD405-TN3-R	UTD405L-TN3-R	TO-252	G	D	S	Tape Reel
UTD405-TN3-T	UTD405L-TN3-T	TO-252	G	D	S	Tube

<p>UTD405L-TN3-R</p> <p>(1)Packing Type</p> <p>(2)Package Type</p> <p>(3)Lead Plating</p>	<p>(1) R: Tape Reel, T: Tube</p> <p>(2) TN3: TO-252</p> <p>(3) L: Lead Free Plating, Blank: Pb/Sn</p>
---	---

■ ABSOLUTE MAXIMUM RATINGS ($T_A=25^{\circ}\text{C}$ unless otherwise specified)

PARAMETER	SYMBOL	RATINGS	UNIT
Drain-Source Voltage	V_{DSS}	-30	V
Gate-Source Voltage	V_{GSS}	± 20	V
Continuous Drain Current	I_D	-18	A
Pulsed Drain Current	I_{DM}	-40	A
Avalanche Current	I_{AR}	-18	A
Repetitive Avalanche Energy(L=0.1mH)	E_{AR}	40	mJ
Power Dissipation	P_D	2.5	W
Junction Temperature	T_J	+150	$^{\circ}\text{C}$
Storage Temperature	T_{STG}	-55 ~ +150	$^{\circ}\text{C}$

Note: Absolute maximum ratings are those values beyond which the device could be permanently damaged.

Absolute maximum ratings are stress ratings only and functional device operation is not implied.

■ THERMAL DATA

PARAMETER	SYMBOL	MIN	TYP	MAX	UNIT
Junction-to-Ambient	θ_{JA}		40	50	$^{\circ}\text{C}/\text{W}$

■ ELECTRICAL CHARACTERISTICS ($T_J = 25^{\circ}\text{C}$, unless otherwise noted)

PARAMETER	SYMBOL	TEST CONDITIONS	MIN	TYP	MAX	UNIT
OFF CHARACTERISTICS						
Drain-Source Breakdown Voltage	BV_{DSS}	$V_{GS}=0\text{ V}, I_D=-250\ \mu\text{A}$	-30			V
Drain-Source Leakage Current	I_{DSS}	$V_{DS}=-24\text{ V}, V_{GS}=0\text{ V}$		-0.003	-1	μA
Gate-Body Leakage Current	I_{GSS}	$V_{DS}=0\text{ V}, V_{GS}=\pm 20\text{V}$			± 100	nA
ON CHARACTERISTICS						
Gate-Threshold Voltage	$V_{GS(TH)}$	$V_{DS}=V_{GS}, I_D=-250\ \mu\text{A}$	-1.2	-2	-2.4	V
On state drain current	$I_{D(ON)}$	$V_{GS}=-10\text{V}, V_{DS}=-5\text{V}$	-40			A
Static Drain-Source On-Resistance	$R_{DS(ON)}$	$V_{GS}=-10\text{ V}, I_D=-18\text{A}$		24.5	32	m Ω
		$V_{GS}=-4.5\text{ V}, I_D=-10\text{A}$		41	60	m Ω
DYNAMIC PARAMETERS						
Input Capacitance	C_{ISS}	$V_{DS}=-15\text{ V}, V_{GS}=0\text{V}, f=1\text{MHz}$		920	1100	pF
Output Capacitance	C_{OSS}			190		pF
Reverse Transfer Capacitance	C_{RSS}			122		pF
SWITCHING PARAMETERS						
Total Gate Charge	Q_G	$V_{DS}=-15\text{V}, V_{GS}=-10\text{V}, I_D=-18\text{ A}$		18.7	23	nC
Gate-Source Charge	Q_{GS}			2.54		nC
Gate-Drain Charge	Q_{GD}			5.4		nC
Turn-ON Delay Time	$t_{D(ON)}$	$V_{GS}=-10\text{V}, V_{DS}=-15\text{V}, R_L=0.82\ \Omega, R_{GEN}=3\ \Omega$		9	13	ns
Turn-ON Rise Time	t_R			25	35	ns
Turn-OFF Delay Time	$t_{D(OFF)}$			20	30	ns
Turn-OFF Fall-Time	t_F			12	18	ns
SOURCE- DRAIN DIODE RATINGS AND CHARACTERISTICS						
Drain-Source Diode Forward Voltage	V_{SD}	$I_S=-1\text{A}, V_{GS}=0\text{V}$		-0.76	-1	V
Maximum Continuous Drain-Source Diode Forward Current	I_S				-18	A
Body Diode Reverse Recovery Time	t_{RR}	$I_F=-18\text{A}, dI/dt=100\text{A}/\mu\text{s}$		21.4	26	ns
Body Diode Reverse Recovery Charge	Q_{RR}	$I_F=-18\text{A}, dI/dt=100\text{A}/\mu\text{s}$		13	16	nC

Notes: 1. Pulse width limited by $T_{J(MAX)}$

2. Pulse width $\leq 300\ \mu\text{s}$, duty cycle 0.5% max.

TYPICAL CHARACTERISTICS

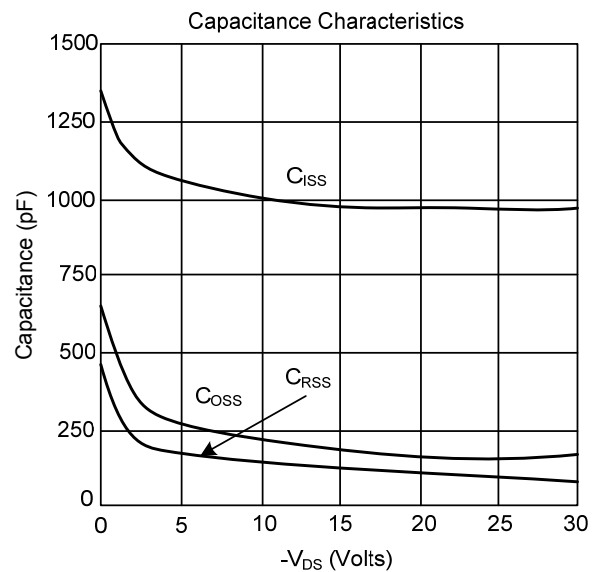
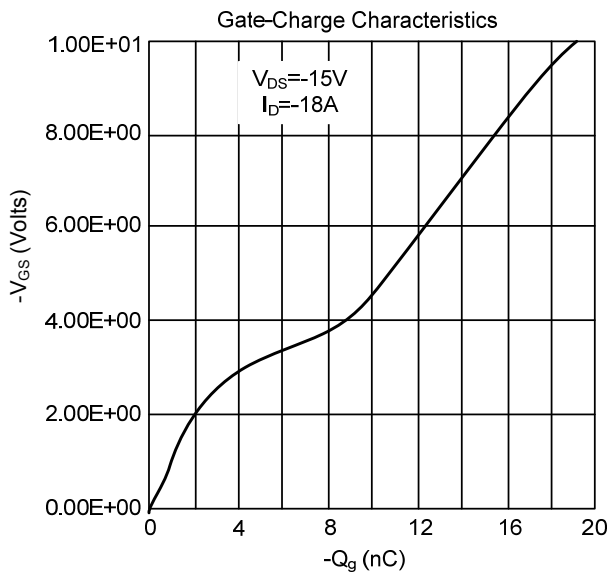
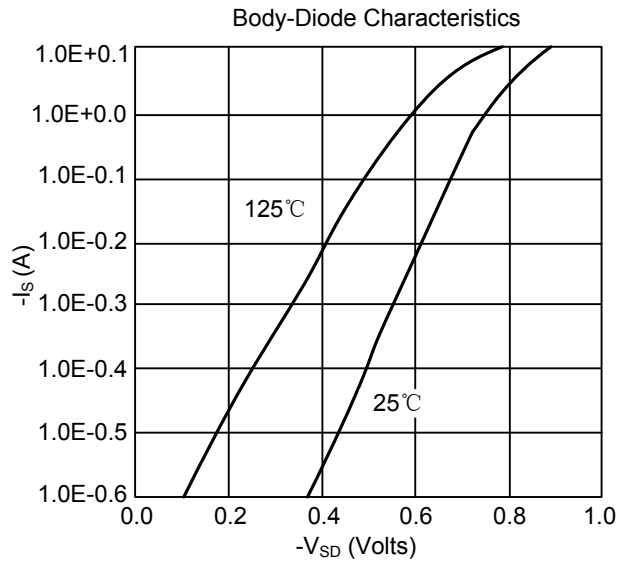
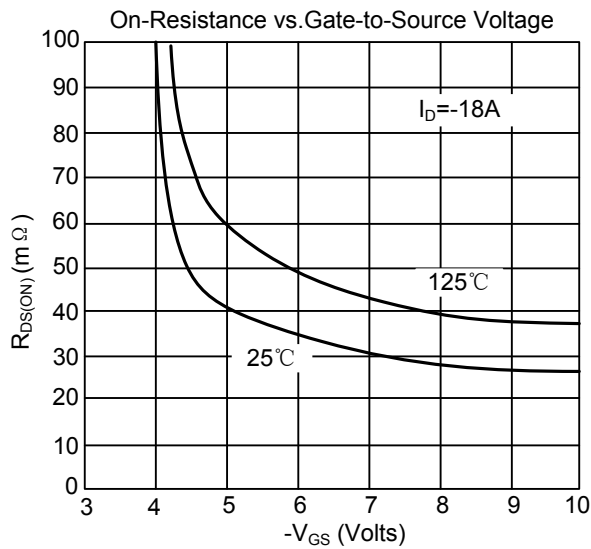
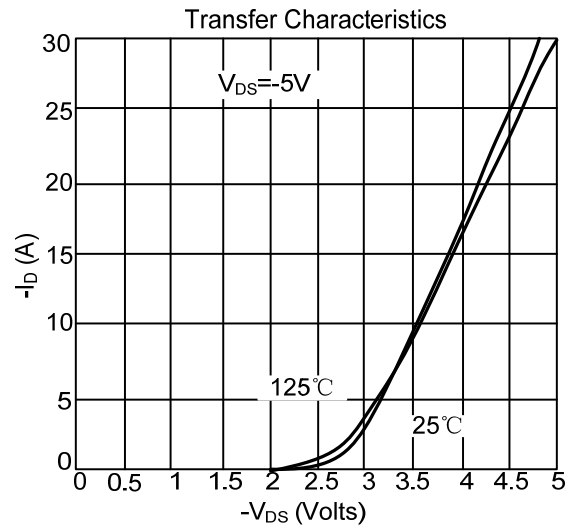
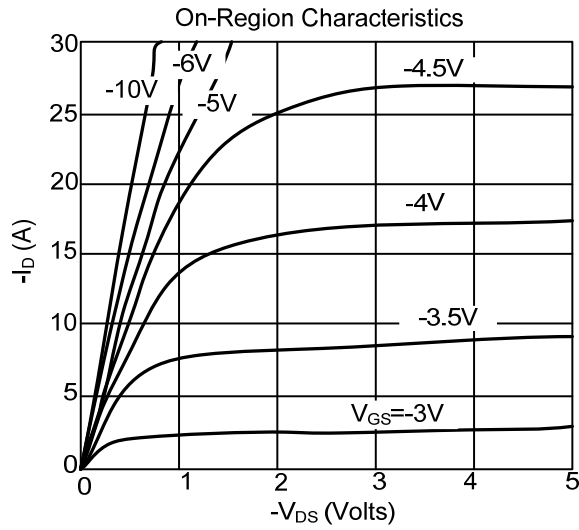

■ TYPICAL CHARACTERISTICS(Cont.)

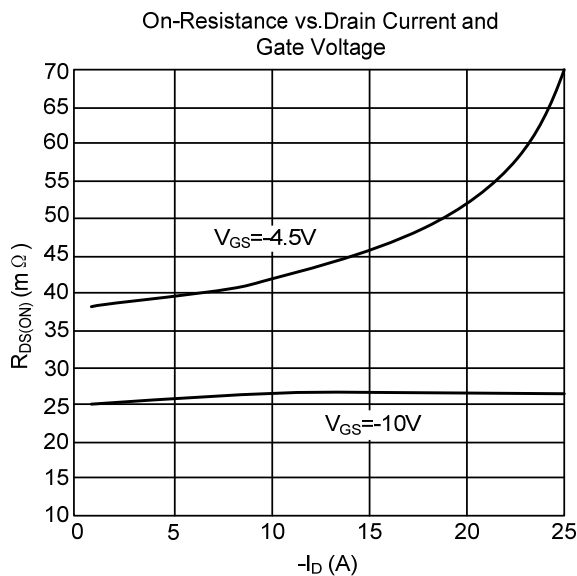
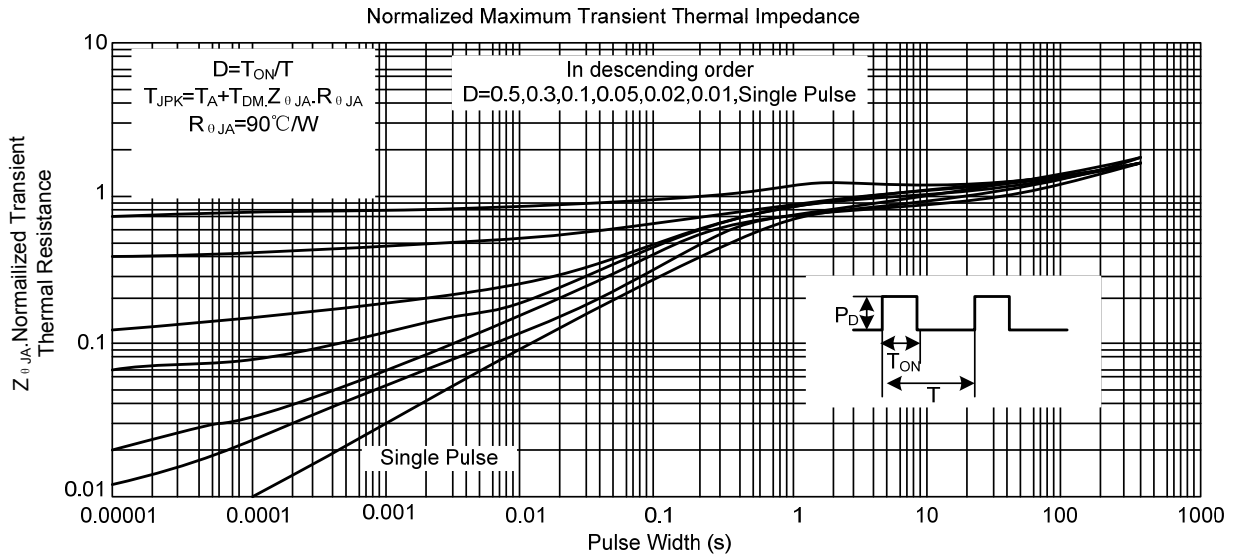
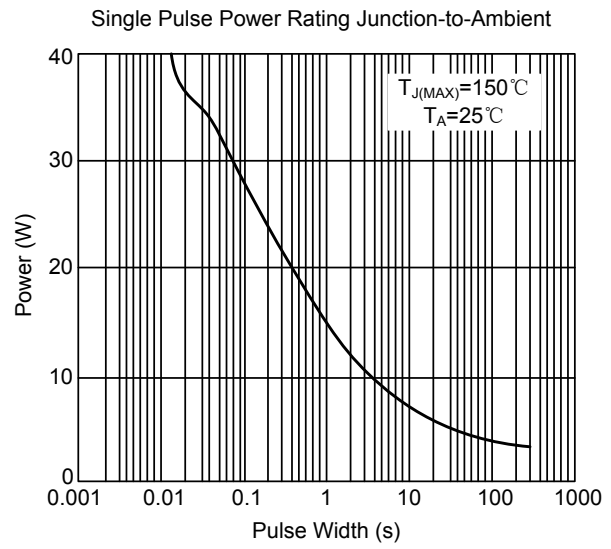
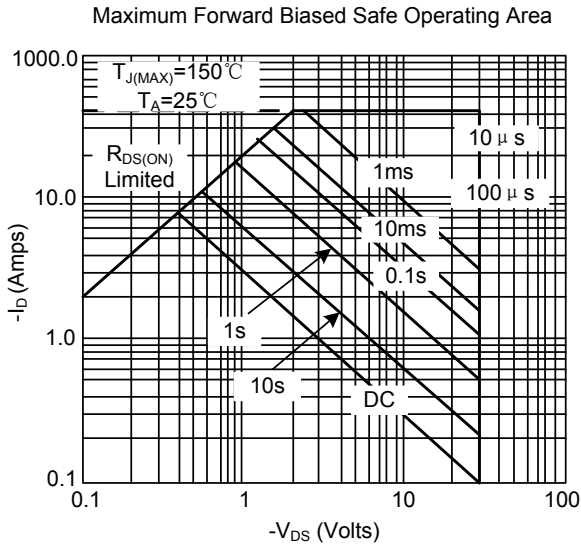

UTC assumes no responsibility for equipment failures that result from using products at values that exceed, even momentarily, rated values (such as maximum ratings, operating condition ranges, or other parameters) listed in products specifications of any and all UTC products described or contained herein. UTC products are not designed for use in life support appliances, devices or systems where malfunction of these products can be reasonably expected to result in personal injury. Reproduction in whole or in part is prohibited without the prior written consent of the copyright owner. The information presented in this document does not form part of any quotation or contract, is believed to be accurate and reliable and may be changed without notice.