

# HDSP-C5x1/C5x3

## 0.52" Single Digit PCB Based LED Display



### Data Sheet

#### Description

This is 0.52" height single digit display. It utilizes GaAsP/ GaP Red, Orange, Yellow, Green and AlGaAs/GaAs Red chips. This device is halogenated.

All devices are categorized for luminous intensity. The orange, yellow and green devices are categorized for color. Use of similar device categories will yield a uniform display.

#### Features

- High reliability
- Excellent characters appearance
- Available in CA and CC
- RoHS Compliant
- Gray top surface with white diffused segments.

#### Ordering Information

Red	Green	Yellow	Orange	AlGaAs Red	Description
HDSP-C5E1	HDSP-C5G1	HDSP-C5Y1	HDSP-C5L1	HDSP-C5A1	Common Anode, Right Hand Decimal
HDSP-C5E3	HDSP-C5G3	HDSP-C5Y3	HDSP-C5L3	HDSP-C5A3	Common Cathode, Right Hand Decimal

#### Package Dimensions

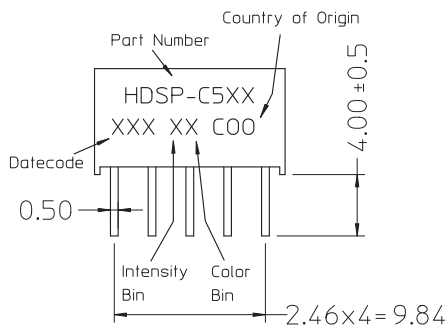
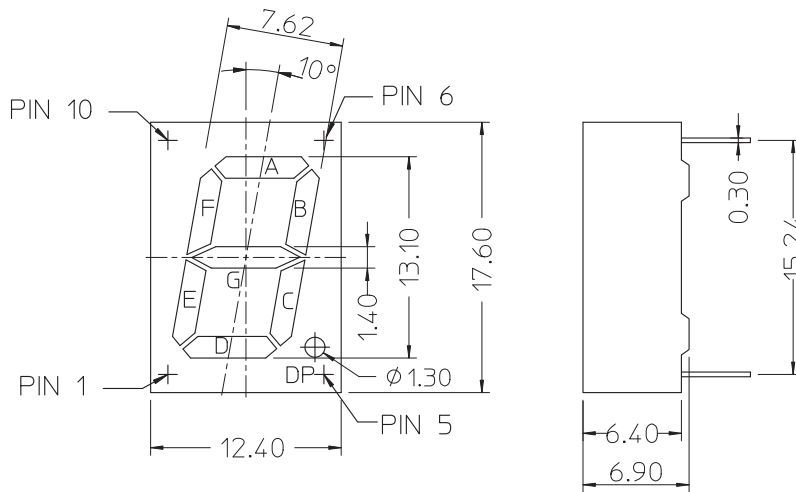

#### Notes:

1. All dimensions are in millimeter.
2. Unless otherwise stated, the tolerance is ± 0.25mm.

## Circuit Diagram

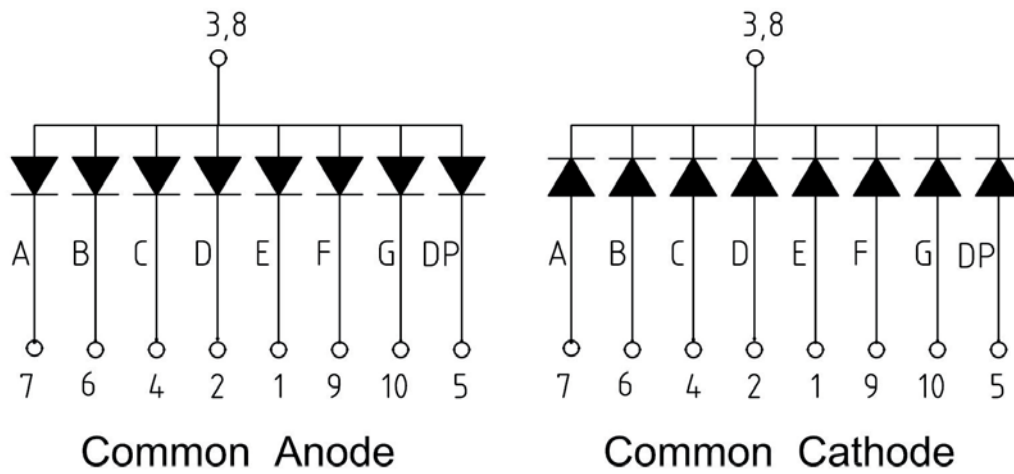

## Absolute Maximum Ratings at $T_A = 25^\circ\text{C}$

Parameter	Symbol	Red/Yellow/ Orange	Green	AlGaAs Red	Units
Power Dissipation per segment or Dot Point (DP)	$P_D$	57.5	62.5	50	mW
Continuous Forward Current per segment	$I_F$	25	25	25	mA
Peak Forward Current per segment (1/10 Duty Cycle, 0.1m sec pulse width)		80	80	80	mA
Derating Linearly from 25°C per segment		0.33	0.33	0.33	mA/°C
Reverse Voltage per segment or DP	$V_R$		5		V
Operating Temperature	$T_O$		-40 to 85		°C
Storage Temperature	$T_S$		-40 to 85		°C
Wave solder Condition 1.6mm below body			250°C peak for 3 secs max		

**Electrical / Optical Characteristic at  $T_A = 25^\circ\text{C}$** **Red**

Parameter	Symbol	Min	Typ	Max	Units	Test Conditions
Average Luminous Intensity (Digit Average)	$I_V$	–	4.0	–	mcd	$I_F = 10\text{mA}$
Peak Wavelength	$\lambda_p$	–	640	–	nm	$I_F = 20\text{mA}$
Dominant Wavelength	$\lambda_d$	–	626	–	nm	$I_F = 20\text{mA}$
Forward Voltage per segment or DP	$V_F$	–	2.0	2.3	V	$I_F = 20\text{mA}$
Reverse Current	$I_R$	–	–	100	$\mu\text{A}$	$V_R = 5\text{V}$
Luminous Intensity Matching Ratio (Segment to Segment)	$I_{V-M}$		2:1			$I_F = 10\text{mA}$

**Green**

Parameter	Symbol	Min	Typ	Max	Units	Test Conditions
Average Luminous Intensity (Digit Average)	$I_V$	–	6.0	–	mcd	$I_F = 10\text{mA}$
Peak Wavelength	$\lambda_p$	–	565	–	nm	$I_F = 20\text{mA}$
Dominant Wavelength	$\lambda_d$	–	569	–	nm	$I_F = 20\text{mA}$
Forward Voltage per segment or DP	$V_F$	–	2.25	2.5	V	$I_F = 20\text{mA}$
Reverse Current	$I_R$	–	–	100	$\mu\text{A}$	$V_R = 5\text{V}$
Luminous Intensity Matching Ratio (Segment to Segment)	$I_{V-M}$		2:1			$I_F = 10\text{mA}$

**Yellow**

Parameter	Symbol	Min	Typ	Max	Units	Test Conditions
Average Luminous Intensity (Digit Average)	$I_V$	–	3.0	–	mcd	$I_F = 10\text{mA}$
Peak Wavelength	$\lambda_p$	–	587	–	nm	$I_F = 20\text{mA}$
Dominant Wavelength	$\lambda_d$	–	589	–	nm	$I_F = 20\text{mA}$
Forward Voltage per segment or DP	$V_F$	–	2.15	2.3	V	$I_F = 20\text{mA}$
Reverse Current	$I_R$	–	–	100	$\mu\text{A}$	$V_R = 5\text{V}$
Luminous Intensity Matching Ratio (Segment to Segment)	$I_{V-M}$		2:1			$I_F = 10\text{mA}$

## Orange

Parameter	Symbol	Min	Typ	Max	Units	Test Conditions
Average Luminous Intensity (Digit Average)	$I_V$	–	4.0	–	mcd	$I_F = 10\text{mA}$
Peak Wavelength	$\lambda_p$	–	610	–	nm	$I_F = 20\text{mA}$
Dominant Wavelength	$\lambda_d$	–	605	–	nm	$I_F = 20\text{mA}$
Forward Voltage per segment or DP	$V_F$	–	2.15	2.3	V	$I_F = 20\text{mA}$
Reverse Current	$I_R$	–	–	100	$\mu\text{A}$	$V_R = 5\text{V}$
Luminous Intensity Matching Ratio (Segment to Segment)	$I_{V-M}$		2:1			$I_F = 10\text{mA}$

## AlGaAs Red

Parameter	Symbol	Min	Typ	Max	Units	Test Conditions
Average Luminous Intensity (Digit Average)	$I_V$	–	16	–	mcd	$I_F = 10\text{mA}$
Peak Wavelength	$\lambda_p$	–	660	–	nm	$I_F = 20\text{mA}$
Dominant Wavelength	$\lambda_d$	–	643	–	nm	$I_F = 20\text{mA}$
Forward Voltage per segment or DP	$V_F$	–	1.85	2.0	V	$I_F = 20\text{mA}$
Reverse Current	$I_R$	–	–	100	$\mu\text{A}$	$V_R = 5\text{V}$
Luminous Intensity Matching Ratio (Segment to Segment)	$I_{V-M}$		2:1			$I_F = 10\text{mA}$

## Red

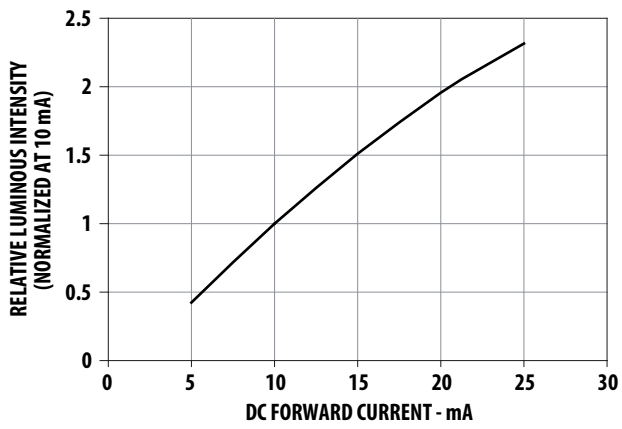

Figure 1. Relative Luminous Intensity Vs Forward Current

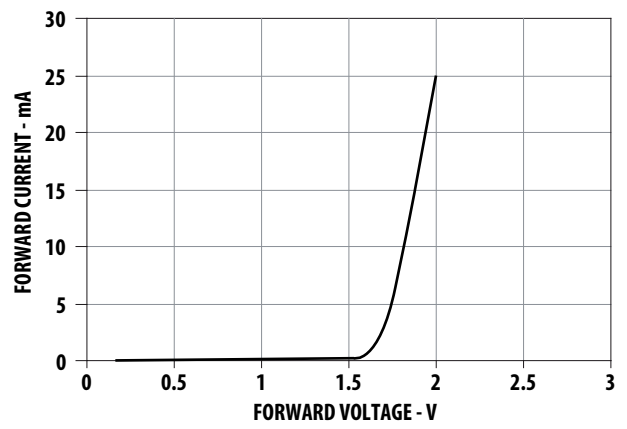

Figure 2. Forward Voltage Vs Current

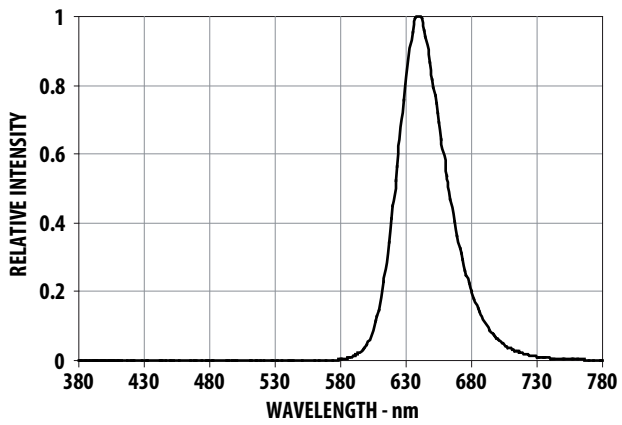

Figure 3. Relative Luminous Intensity Vs Wavelength

## Green

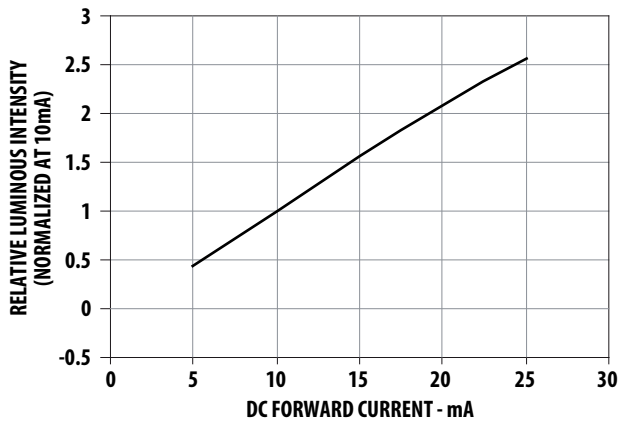

Figure 4. Relative Luminous Intensity Vs Forward Current

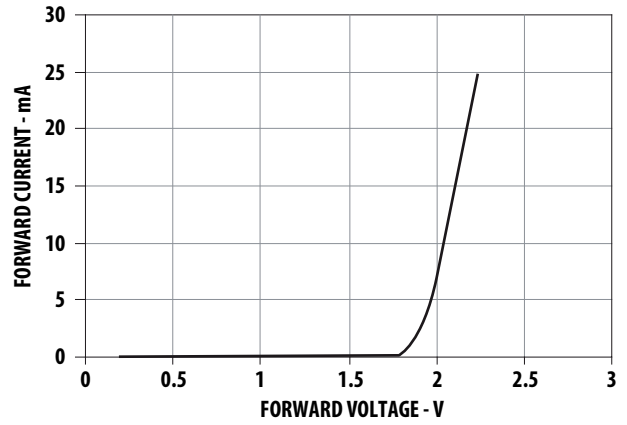

Figure 5. Forward Voltage Vs Current

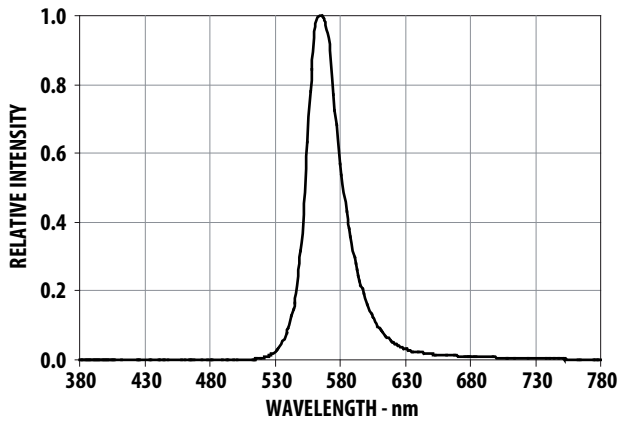

Figure 6. Relative Luminous Intensity Vs Wavelength

## Yellow

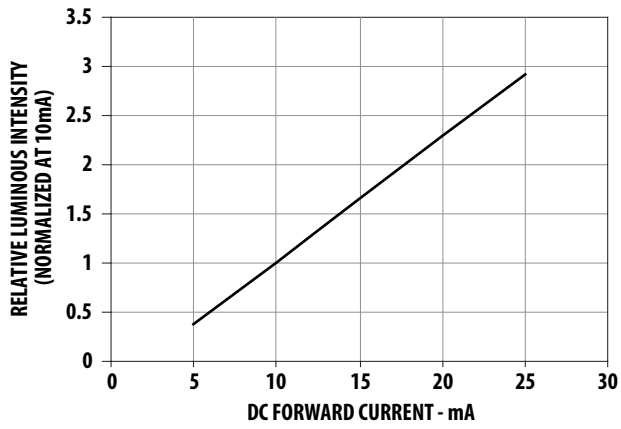

Figure 7. Relative Luminous Intensity Vs Forward Current

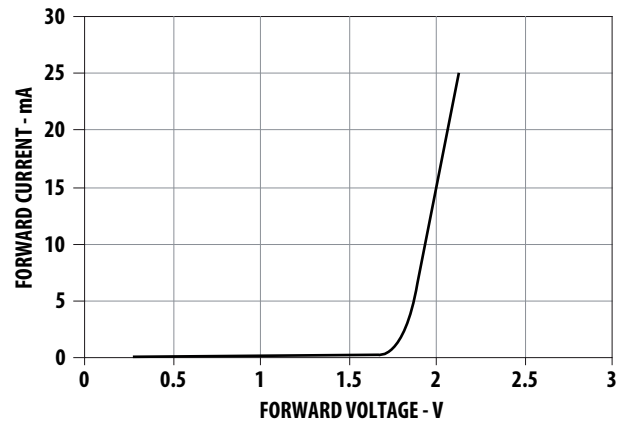

Figure 8. Forward Voltage Vs Current

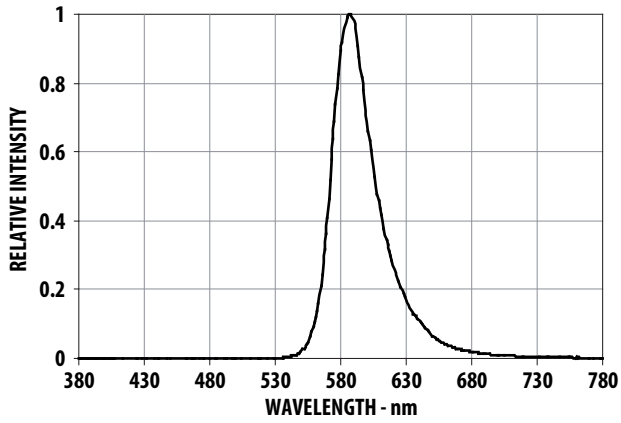

Figure 9. Relative Luminous Intensity Vs Wavelength

## Orange

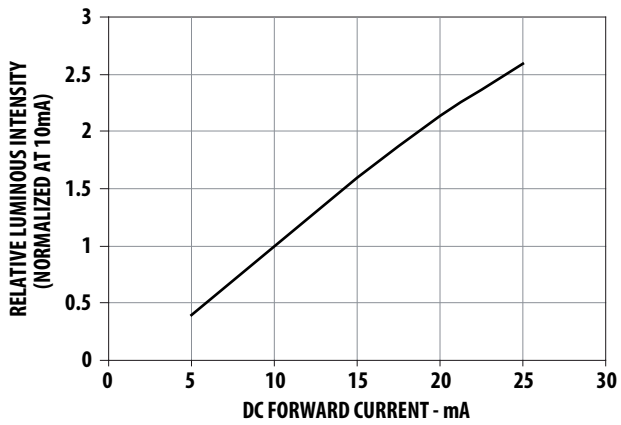

Figure 10. Relative Luminous Intensity Vs Forward Current

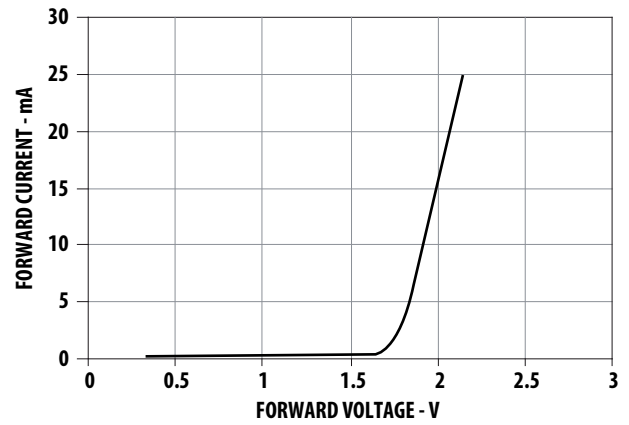

Figure 11. Forward Voltage Vs Current

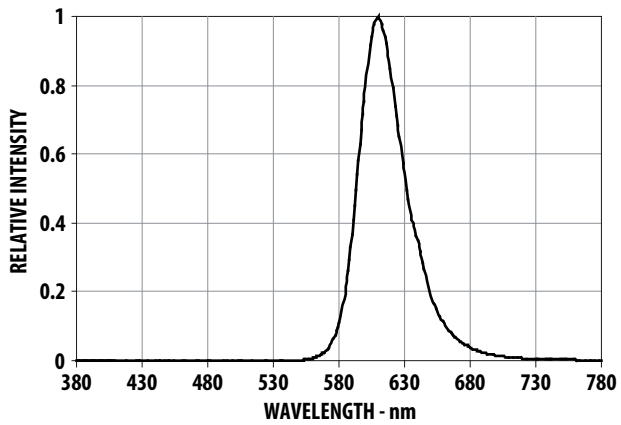

Figure 12. Relative Luminous Intensity Vs Wavelength



## AlGaAs Red

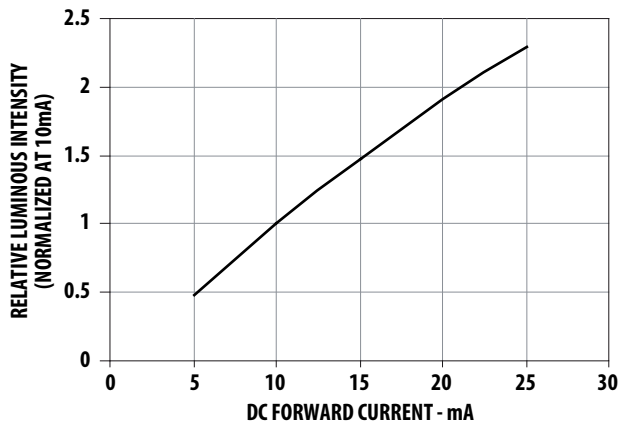

Figure 13. Relative Luminous Intensity Vs Forward Current

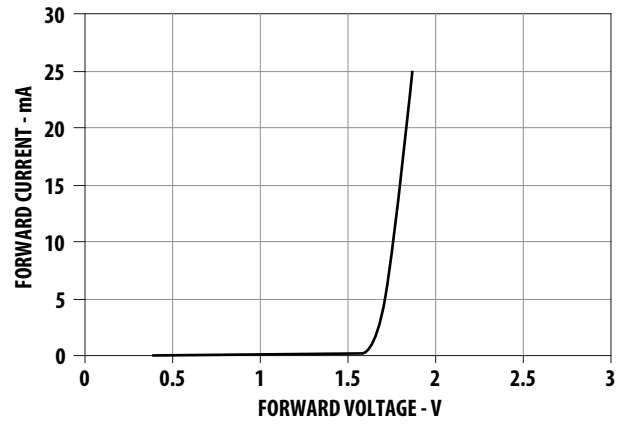

Figure 14. Forward Voltage Vs Current

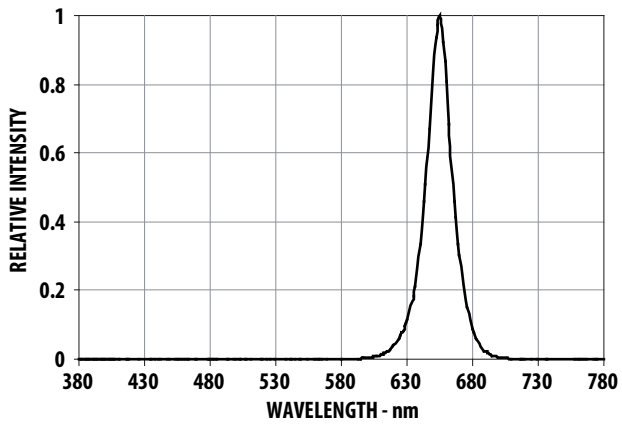
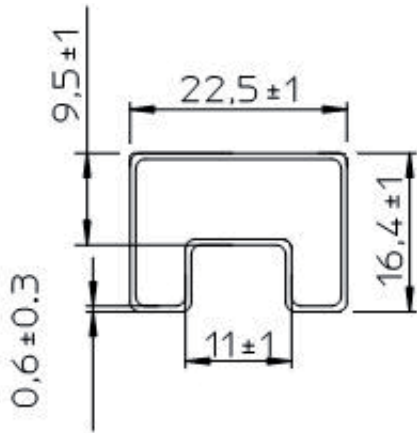
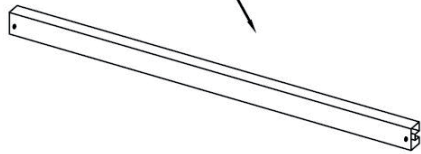

Figure 15. Relative Luminous Intensity Vs Wavelength

**Packing Tube Specifications:**

25 PCS PRODUCTS PER IC TUBE



**Tube Front View**



**Tube Top View**

For product information and a complete list of distributors, please go to our web site: [www.avagotech.com](http://www.avagotech.com)

Avago, Avago Technologies, and the A logo are trademarks of Avago Technologies in the United States and other countries. Data subject to change. Copyright © 2005-2010 Avago Technologies. All rights reserved. AV02-2493EN - October 19, 2010

