



Features

- RoHS lead-free-solder and lead-solder-exempted products are available
- Single board design
- Basic insulation
- 1500 VDC i/o electric strength test voltage
- Low profile SMT design
- High current density
- Low conducted and radiated EMI
- Excellent co-planarity (within 0.1 mm)
- Output overcurrent protection
- Full rated output power at 100 LFM airflow
- Operating temperature to 100 °C
- Remote shutdown (primary referenced)
- Output voltage trim adjust, positive or negative
- 8.5 mm height profile
- Safety-approved to IEC/EN 60950-1 and UL/CSA 60950-1.

Applications

- Distributed power architectures
- Telecommunications equipment
- LAN/WAN applications
- Data processing
- Industrial applications

Description

The NDS Series of converters are low profile, single output, DC-DC converters intended for SMT placement and reflow soldering. The product provides onboard conversion of standard telecom, datacom and industrial input voltages to isolated low output voltages. Proprietary patented manufacturing process ensures optimal quality with full process automation. These are high performance, cost effective converters with an extremely small PCB footprint.

Model Selection

Model	Input Voltage VDC	Max. input Current A	Output Voltage V	Output Current A	Output Ripple/Noise mV _{pp}	Typical Efficiency %
NDS03ZA-M6 ¹	36 - 75	0.18	1.5	3.0	40	75
NDS03ZB-M6 ¹	36 - 75	0.22	1.8	3.0	45	77
NDS03ZD-M6 ¹	36 - 75	0.28	2.5	3.0	60	83
NDS03ZE-M6 ¹	36 - 75	0.35	3.3	3.0	75	85
NDS02ZG-M6 ¹	36 - 75	0.35	5.0	2.0	90	87

¹ For products RoHS-compliant for all 6 substances, change the suffix -M6 to -M6G.

Model numbers highlighted in yellow or shaded are not recommended for new designs.

Absolute Maximum Ratings

Stresses in excess of the absolute maximum ratings may cause performance degradation, adversely affect long-term reliability and cause permanent damage to the converter. Specifications apply over specified input voltage, output load and temperature range, unless otherwise noted.

Parameter	Conditions/Description	Min	Max	Unit
Input voltage (Vi)	Continuous	36	75	VDC
Transient Input Voltage (Vit)	Transient, 100 ms		100	VDC
Operating CaseTemp. (Tc)	At 100% load	-40	100	°C
Storage Temperature (Ts)		-55	120	°C
ON/OFF Control Voltage (Vrc)	Referenced to -Vi	-1.0	5.5	VDC

Environmental and Mechanical

Specifications apply over specified input voltage, output load, and temperature range, unless otherwise noted.

Parameter	Conditions/Description	Min	Nom	Max	Unit
Shock	IEC68-2-27			100	g
Sinusoidal Vibration	IEC68-2-6			10	g
Weight				0.4/10	oz/g
Water Washing	Standard process	Yes			N/A
MTBF	Per Bellcore TR-NWT-000332 (100% load @25 °C, GB)	6 052 000			h

Insulation

Specifications apply over specified input voltage, output load, and temperature range, unless otherwise noted.

Parameter	Conditions/Description	Min	Nom	Max	Unit
Insulation Safety Rating	Vi = 36 – 75 VDC	Basic			N/A
Electric Strength Test				1500	VDC
Insulation Resistance (Rps)		10			MΩ
Insulation Capacitance (Cps)			4100		pF

Input Data

Specifications apply over specified input voltage, output load, and temperature range, unless otherwise noted.

Parameter	Conditions/Description	Min	Nom	Max	Unit
Input Voltage (Vi)	Continuous	36	48	75	V
Input Current when Shutdown	Vi.Nom, Remote Control activated		3	6	mA
Turn-On Input Voltage 36-75 Vi	Ramping Up, Io.Max	32	34	36	V
Turn-Off Input Voltage 36-75 Vi	Ramping Down, Io.Max	30	32	34	V
Turn-On Time	To Output Regulation Band		350	500	ms
	After Remote Control		1	5	ms
	Rise Time		1	5	ms
Input Reflected Ripple Current	Vi.Max, Io.Max			50	mA _{pp}
Input Capacitance				1.4	μF

Output Data

All specifications apply over input voltage, output load, and temperature range, unless otherwise noted.

NDS03ZA : 1.5 V/3.0 A

Parameter		Conditions/Description	Min	Nom	Max	Unit
Output Voltage Setpoint Accuracy	Vo	Vi.Nom, Io = 1.5 A, 25 °C	1.48	1.50	1.52	VDC
Output Current	Io	Vi.Min to Vi.Max	0		3.0	ADC
Line Regulation		Vi.Min to Vi.Max, 50% Io.Max			25	mV
Load Regulation		Vi.Nom, Io.Min to Io.Max			25	mV
Dynamic Regulation Peak Deviation		50-100% Io.Max load step change.			250	± mV
Settling Time		to 1% error band			1,150	µs
Output Voltage Ripple*	Vr	Vi.Min to Vi.Max, Io.Min to Io.Max, 20 MHz Bandwidth		40	75	mVpp
Admissible Load Capacitance	Comax	Io.Max, Vi.Nom			2,200	µF
Output Current Limit Threshold	Icl	Vo ≤ 0.90 Vo.Nom	120		200	%Io.Max
Switching Frequency	Fs	Vi.Nom, Io.Max		400		kHz
Temperature Coefficient	Tco				0.02	%Vo/°C
Trim Range	Vt	Io.Min to Io.Max, Vi.Min to Vi.Max	1.35		1.65	Vo

* Measured with a 1 µF ceramic across the output pins

Typical Characteristic Curves

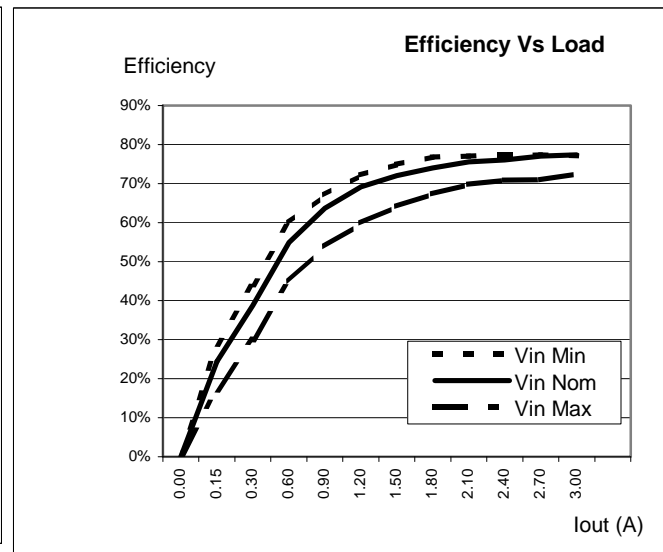
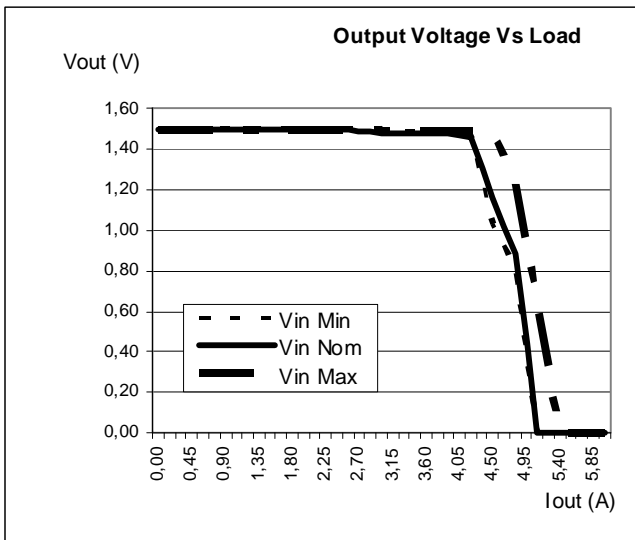

All specifications apply over input voltage, output load, and temperature range, unless otherwise noted.

NDS03ZB : 1.8 V/3.0 A

Parameter		Conditions/Description	Min	Nom	Max	Unit
Output Voltage Setpoint Accuracy	Vo	Vi.Nom, Io = 1.5 A, 25 °C	1.78	1.80	1.82	VDC
Output Current	Io	Vi.Min to Vi.Max	0		3.0	ADC
Line Regulation		Vi.Min to Vi.Max, 50% Io.Max			25	mV
Load Regulation		Vi.Nom, Io.Min to Io.Max			25	mV
Dynamic Regulation Peak Deviation		50-100% Io.Max load step change.			250	± mV
Settling Time		to 1% error band			1,150	µs
Output Voltage Ripple*	Vr	Vi.Min to Vi.Max, Io.Min to Io Max, 20 MHz Bandwidth		50	75	mV _{pp}
Admissible Load Capacitance	Comax	Io.Max, Vi.Nom			2,200	µF
Output Current Limit Threshold	Icl	Vo ≤ 0.90 Vo.Nom	120		200	%Io.Max
Switching Frequency	Fs	Vi.Nom, Io.Max		400		kHz
Temperature Coefficient	Tco				0.02	%Vo/°C
Trim Range	Vt	Io.Min to Io.Max, Vi.Min to Vi.Max	1.62		1.98	Vo

* Measured with a 1 µF ceramic across the output pins

Typical Characteristic Curves

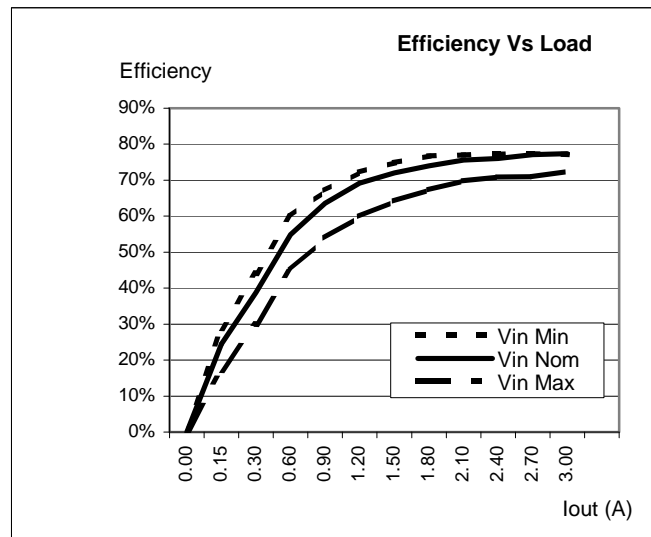
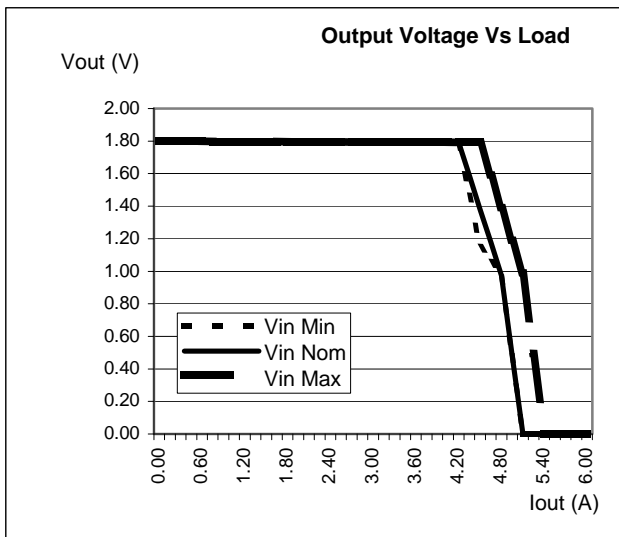

All specifications apply over input voltage, output load and temperature range, unless otherwise noted.

NDS03ZD : 2.5 V/ 3.0A

Parameter		Conditions/Description	Min	Nom	Max	Unit
Output Voltage Setpoint Accuracy	Vo	Vi.Nom, Io = 1.5 A, 25 °C	2.47	2.5	2.53	V
Output Current	Io	Vi.Min to Vi.Max	0		3.0	A
Line Regulation		Vi.Min to Vi.Max, 50% Io.Max			50	mV
Load Regulation		Vi.Nom, Io.Min to Io.Max			50	mV
Dynamic Regulation Peak Deviation		50-100% Io.Max load step change.			250	± mV
Settling Time		to 1% error band			1,150	µs
Output Voltage Ripple	Vr	Vi.Min to Vi.Max, Io.Min to Io Max, 20 MHz Bandwidth		50	75	mV _{pp}
Admissible Load Capacitance	Comax	Io.Max, Vi.Nom			2,200	µF
Output Current Limit Threshold	Icl	Vo ≤0.90 Vo.Nom	120		200	%Io.Max
Switching Frequency	Fs	Vi.Nom, Io.Max		400		kHz
Temperature Coefficient	Tco				0.02	%Vo/°C
Trim Range	Vt	Io.Min to Io.Max, Vi.Min to Vi.Max	2.25		2.75	Vo

* Measured with a 1 µF ceramic across the output pins

Typical Characteristic Curves

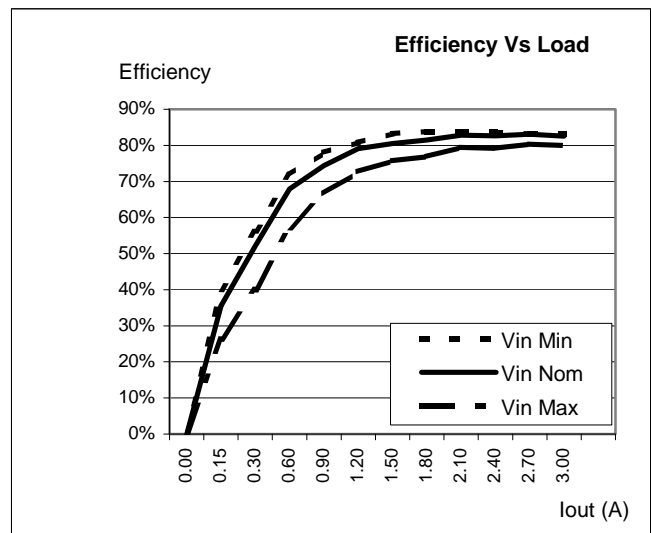
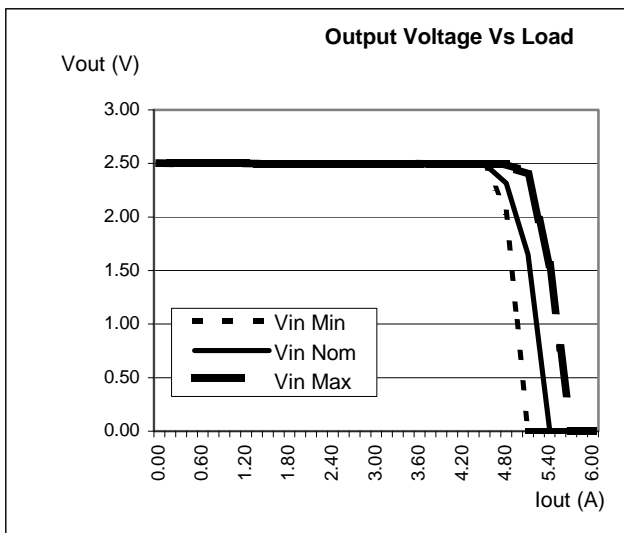

All specifications apply over input voltage, output load and temperature range, unless otherwise noted.

NDS03ZE : 3.3 V/3.0 A

Parameter		Conditions/Description	Min	Nom	Max	Unit
Output Voltage Setpoint Accuracy	Vo	Vi.Nom, Io = 1.5 A, 25 °C	3.26	3.3	3.34	VDC
Output Current	Io	Vi.Min to Vi.Max	0		3.0	ADC
Line Regulation		Vi.Min to Vi.Max, 50% Io.Max			65	mV
Load Regulation		Vi.Nom, Io.Min to Io.Max			65	mV
Dynamic Regulation Peak Deviation		50-100% Io.Max load step change.			250	± mV
Settling Time		to 1% error band			250	µs
Output Voltage Ripple*	Vr	Vi.Min to Vi.Max, Io.Min to Io Max, 20 MHz Bandwidth		50	75	mV _{pp}
Admissible Load Capacitance	Comax	Io.Max, Vi.Nom			2,200	µF
Output Current Limit Threshold	Icl	Vo ≤ 0.90 Vo.Nom	120		200	%Io.Max
Switching Frequency	Fs	Vi.Nom, Io.Max		400		kHz
Temperature Coefficient	Tco				0.02	%Vo/°C
Trim Range	Vt	Io.Min to Io.Max, Vi.Min to Vi.Max	3.0		3.6	Vo

* Measured with an 1 µF ceramic capacitor across the output pins

Typical Characteristic Curves

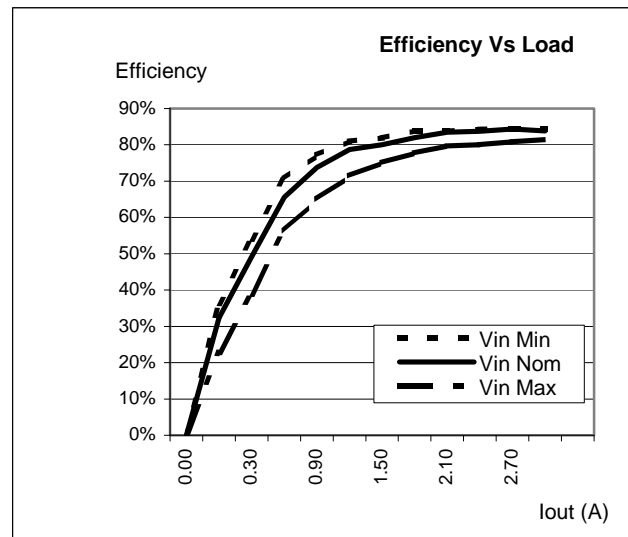
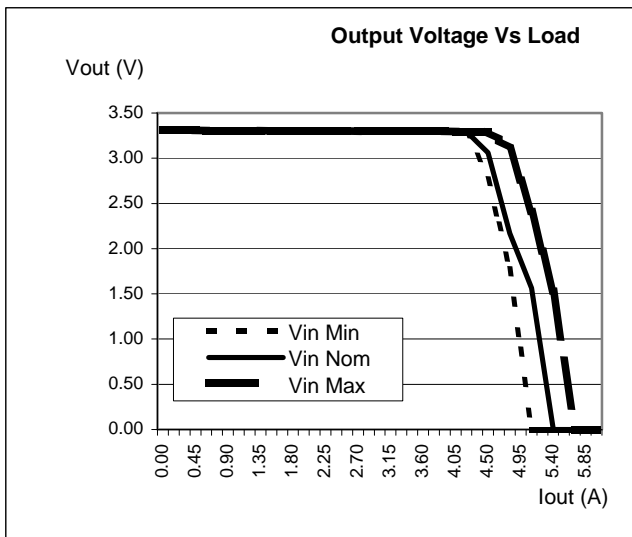

All specifications apply over input voltage, output load and temperature range, unless otherwise noted.

NDS02ZG : 5.0 V/2.0 A

Parameter		Conditions/Description	Min	Nom	Max	Unit
Output Voltage Setpoint Accuracy	Vo	Vi.Nom, Io = 1.0 A, 25 °C	4.94	5.0	5.06	V
Output Current	Io	Vi.Min to Vi.Max	0		2.0	A
Line Regulation		Vi.Min to Vi.Max, 50% Io.Max			65	mV
Load Regulation		Vi.Nom, Io.Min to Io.Max			65	mV
Dynamic Regulation Peak Deviation		50-100% Io.Max load step change.			350	± mV
Settling Time		to 1% error band			250	µs
Output Voltage Ripple*	Vr	Vi.Min to Vi.Max, Io.Min to Io Max, 20 MHz Bandwidth		75	125	mV _{pp}
Admissible Load Capacitance	Comax	Io.Max, Vi.Nom			2,200	µF
Output Current Limit Threshold	Icl	Vo ≤ 0.90 Vo.Nom	120		200	%Io.Max
Switching Frequency	Fs	Vi.Nom, Io.Max		400		kHz
Temperature Coefficient	Tco				0.02	%Vo/°C
Trim Range	Vt	Io.Min to Io.Max, Vi.Min to Vi.Max	4.5		5.5	Vo

* Measured with a 1 µF ceramic across the output pins

Typical Characteristic Curves

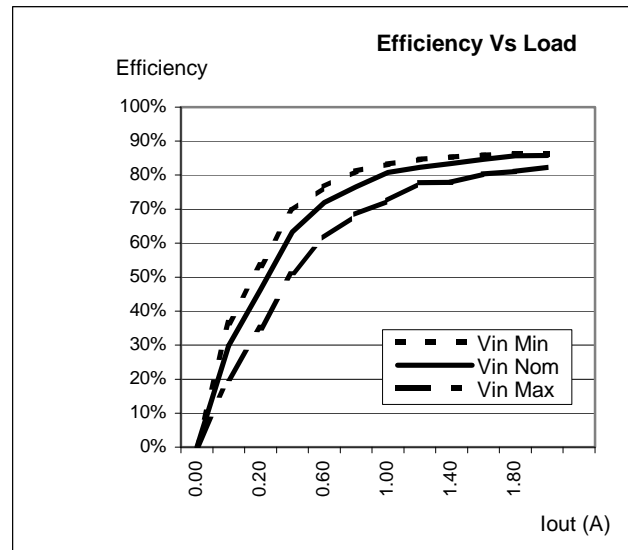
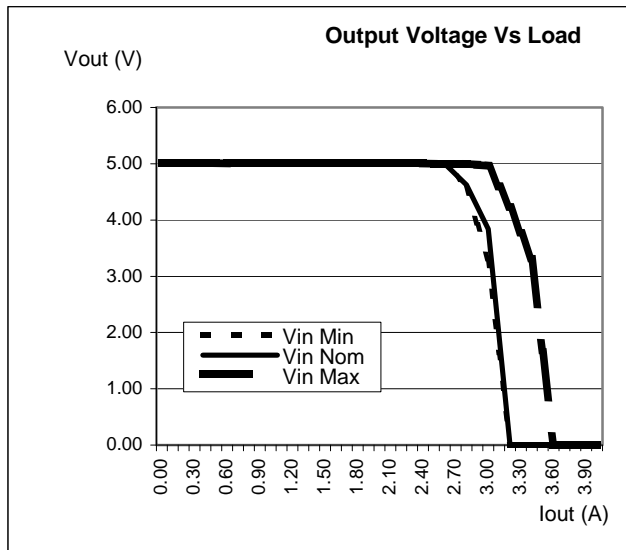

Shutdown

Parameter	Conditions/Description	Min	Nom	Max	Units
Shutdown Control: Converter OFF Converter ON Sink Current	Shutdown pin is pulled low Voltage source or open circuit $V_i = V_i \cdot \text{Nom}$	-1.0 3.5	0.3	1.0 5.5	V V mA

Temperature Derating Curves

The derating curves below give an indication of the output power achievable with and without forced-air cooling. However in the final application, in order to ensure the reliability of the unit, care must be taken to ensure the maximum case temperature is not exceeded under any conditions.

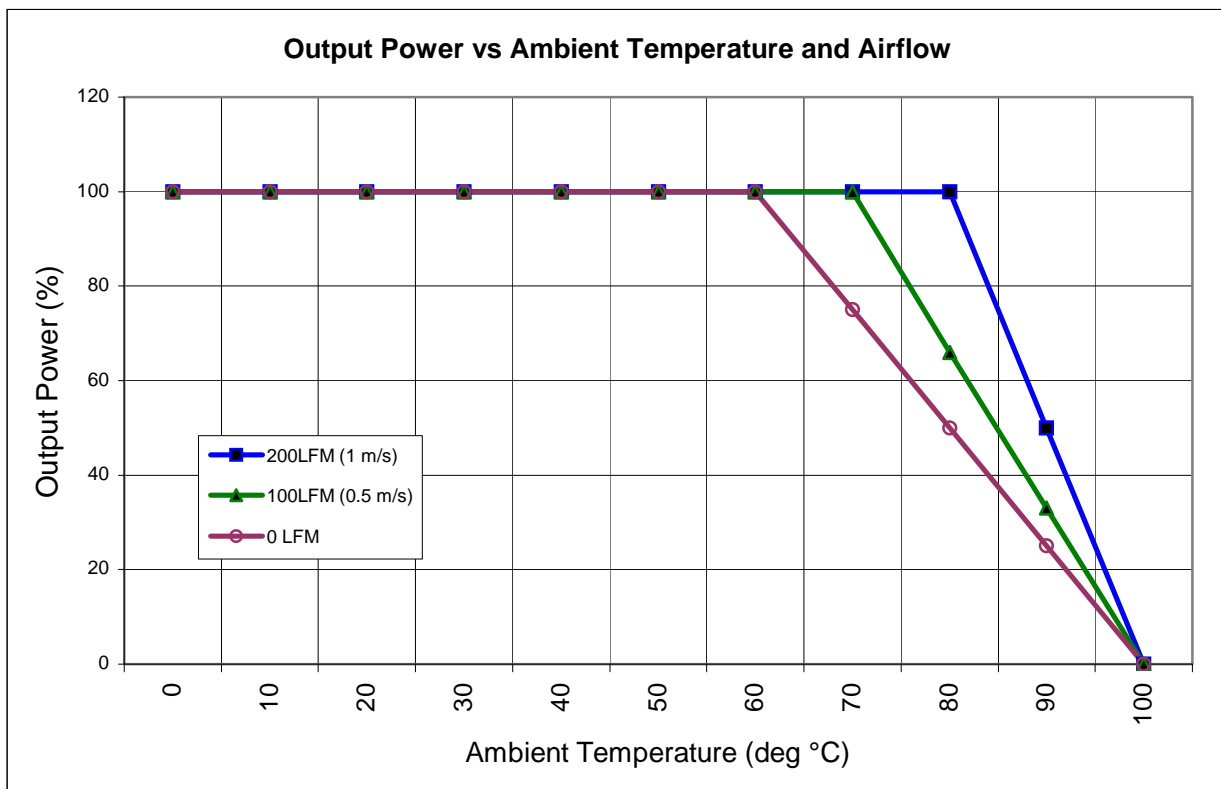

Application and Auxiliary Functions

This series of converters does not require any external components for proper operation. However, if the distribution of the input voltage to the converter contains significant inductance, a capacitor across the input terminals may be required to stabilize the input voltage. A minimum of 1 μ F, quality electrolytic / ceramic capacitor is recommended for this purpose. For output decoupling it is recommend connecting a 1 μ F ceramic capacitor directly across the output pins of the converter.

Shutdown Feature

The remote control pin functions as a normal soft shutdown. It is referenced to the $-V_i$ pin. With positive logic, when the remote control pin is pulled low, the output is turned off and the unit goes into a very low input power mode.

An open collector switch is recommended to control the voltage between the remote control pin and the $-V_i$ pin of the converter. The remote control pin is pulled up internally, so no external voltage source is required. The user should avoid connecting a resistor between the remote control pin and the $+V_i$ pin.

The user must take care to ensure that the pin reference for the control is connected close to the $-V_i$ pin. The control signal must not be referenced ahead of EMI filtering, or remotely from the unit. If the remote control pin is not used, it can be left floating.

Thermal Considerations

The converter is designed for natural or forced convection cooling. The output power of the converter is limited by the maximum case temperature (T_c). To ensure reliable long term operation of the converters, and to comply with safety agency requirements, Power-One limits maximum allowable case temperature (T_c) to 100 °C; see *Mechanical Drawings*.

Parallel Operation

Paralleling of two converters is not possible.

Output Current Limiting

When the output is overloaded above the maximum output current rating, the voltage will start to reduce to maintain the output power to a safe level. In a condition of high overload or short-circuit, where the output voltage is pulled below approximately 30% of $V_{o.Nom}$, the unit will enter a 'Hiccup' mode of operation. Under this condition the unit will attempt to restart, approximately every 25 ms, until the overload has cleared.

Output Voltage Adjustment

The trim feature allows the user for adjusting the output voltage by means of an external resistor. To increase V_o a resistor should be connected between pins 12 and 14. To decrease V_o a resistor should be connected between pins 12 and 13.

To **increase** V_o :

$$R_{ext} = (A - (D \times V_o)) / (V_o - V_{o.Nom}) \quad [\Omega]$$

To **reduce** V_o :

$$R_{ext} = ((B \times V_o) - C) / (V_{o.Nom} - V_o), \quad [\Omega]$$

Where V_o is the desired output voltage

Model	A	B	C	D
NDS03ZA	1945	1470	1944	470
NDS03ZB	2590	1730	2560	750
NDS03ZD	5010	2516	5010	1500
NDS03ZE	7010	3161	7010	1500
NDS02ZG	11260	4532	11240	1500

Note: When the output voltage is trimmed up, the output power from the converter must not exceed its maximum rating. This is determined by measuring the voltage on the output pins, and multiplying it by the output current.

Safety

These converters are tested with 1500 VDC from input to output. The input-to-output resistance is greater than 10 MΩ. These converters are provided with Basic Insulation between input and output. Nevertheless, if the system using the converter needs to receive safety agency approval, certain rules must be followed in the design of the system. In particular, all of the creepage and clearance requirements of the end-use safety requirements must be observed.

In order for the output of the converter to be considered as SELV (Safety Extra Low Voltage) or TNV-1, according to IEC/EN 60950-1 and UL/CSA 60950-1, one of the following requirements must be met in the system design:

- **Fuse:** The converter has no internal fuse. An external fuse must be provided to protect the system from catastrophic failure. A fuse with a rating not greater than 2.0 A is recommended. The user can select a lower rating fuse based upon the inrush transient and the maximum input current of the converter, which occurs at the minimum input voltage. Both input traces and the chassis ground trace (if applicable) must be capable of conducting a current of 1.5 times the value of the fuse without opening. The fuse must not be placed in the grounded input line, if any.
- If the voltage source feeding the module is SELV, the output of the converter is considered SELV and may be grounded or ungrounded.
- The circuitry of the converter may generate transients, which exceed the input voltage. Even if the input voltage is SELV (<60 V) the components on the primary side of the converter may have to be considered as hazardous. A safety interlock may be needed to prevent the user from accessing the converter while operational.

EMC Specifications

Conducted Noise:

The converters meet the requirements class A of EN 55022 (conducted noise on the input terminals) without any external components. The results for this solution are displayed below.

To meet class B for the above standards, it is necessary to fit a 5 μF ceramic capacitor across the input terminals.

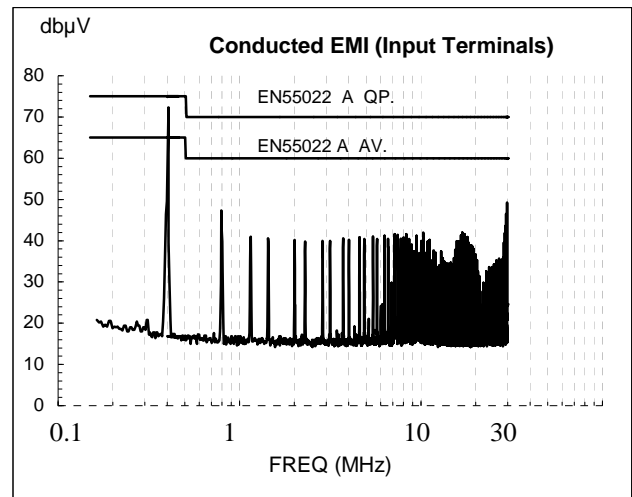

Electromagnetic Susceptibility:

Standard	Applied Stress	Class Level	Performance Criterion *
Electrostatic Discharge EN 61000-4-2	2 kV to pins	1	B
Electromagnetic Field EN 61000-4-3	3 V/m	2	A
Electrical Fast Transient EN 61000-4-4	2000 V _p to input	3	B
Conducted Disturbances EN 61000-4-6	3 V _{rms} to input	2	B

* **A** denotes normal operation, no deviation from specification. **B** denotes temporary deviation from specification is possible.

Mechanical Data

Dimensions in mm [inches]

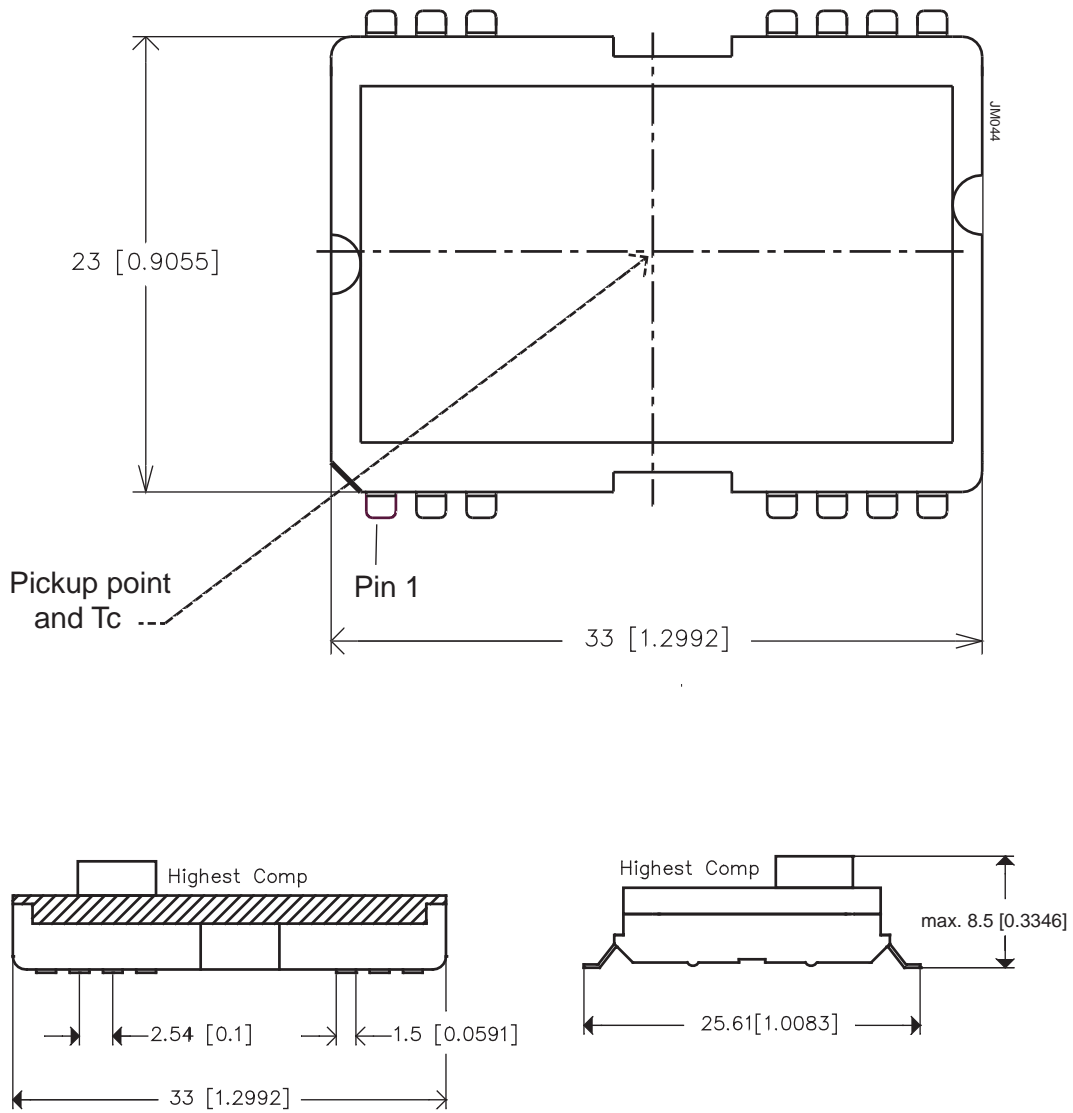

Surface Mount Assembly

Soldering

The following soldering instructions must be observed to prevent failure or significant degradation of the module performance. Power-One will not honor any warranty claims arising from failure to observe these instructions.

The lead-frame is constructed for a high temperature glass filled, UL94 V-0 flame retardant, dually orthophthalate molding compound commonly used for packaging of electronics components. It has passed NASA outgassing tests, and is certified to MIL-M-14. The coefficient of thermal expansion is equivalent to FR4.

The gull wing leads are formed to ensure optimal solder joint strength and structure. Furthermore they facilitate visual inspection (manual or automatic). The leads are formed from a 97% Cu alloy plated with Ni and matte Sn. This material is commonly used

in the manufacture of integrated circuits. It has good corrosion resistance and exhibits the nobility inherent to all high copper alloys. Unlike brasses, this material is essentially immune to stress corrosion cracking. It also exhibits excellent solderability. It is readily wetted by solders and performs well in standard solderability tests. (Dip of Class II or better).

The product is manufactured with a patented process, which is fully automated, and 'in-line'. This ensures that there is no contamination or mechanical stress on the lead-frame so that the co planarity and solderability are maintained.

The product is shipped in JEDEC trays to ensure preservation of the co-planarity and enable fully automated assembly in the final application. Mind the marking for pin 1!

These products are approved for forced convection reflow soldering only. Products RoHS-compliant for all 6 substances (model designation ending with -M6G) allow for a solder profile with higher temperatures; see tables below.

Recommended Reflow Profile (measured at the leads of the converter)

Product	Pre-heat ramp			Pre-heat soaking			Ramp to reflow	Reflow				Cooling
	From °C	To °C	Rate °C/s	From °C	To °C	Time s	Rate °C	Time above liquidus s	Peak temp. °C	Time within ±5 °C of peak temp s	Time to peak s	Rate °C/s
-M6 (Sn-Pb eutectic)	25	150	2	150	183	90 - 120	2	45	220 ±5	10	180	4
-M6G (lead-free)	25	180	2	180	217	90 - 120	2	45	240 ±5	10	210	4

Worst Case Reflow Parameters Following J-STD-020D (measured in the center, on top side of the converter)

Product	Pre-heat ramp			Pre-heat soaking			Ramp to reflow	Reflow				Cooling
	From °C	To °C	Rate °C/s	From °C	To °C	Max. time s	Rate °C	Max. time above liquidus s	Max. peak temp. °C	Max. time within ±5 °C of peak temp. s	Max. time to peak s	Rate °C/s
-M6 (Sn-Pb eutectic)	25	150	3	100	150	120	3	45	230	10	360	6
-M6G (lead-free)	25	180	3	150	200	120	3	45	260	10	480	6

Pick & Place Assembly

The product is designed with a large flat area in the center of the top surface to serve as a pick up point for automated vacuum pick and place equipment. The 'open board' construction of the unit ensures that weight is kept to a minimum. However due to the relatively large size of the component, a large nozzle (>6.0mm, depending on vacuum pressure) is recommended for picking and placing.

The unit may also be automatically handled using 'odd-form' placement equipment, with mechanical grippers. For this type of equipment the end edges of the device, which have no leads and also feature the greatest dimensional accuracy, should be used as pick-up points.

Recommended Solder Lands

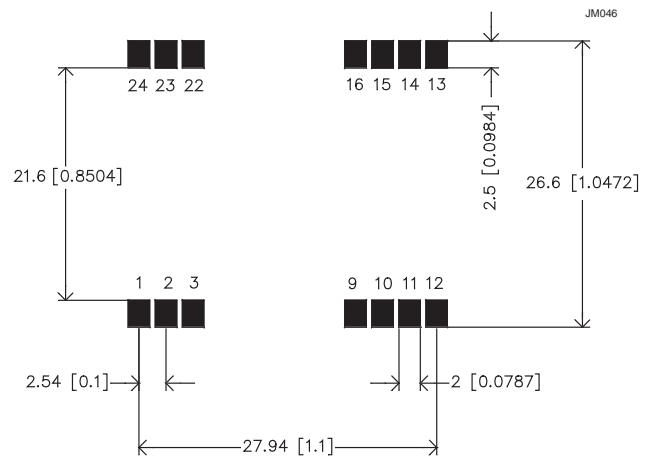

Packaging: JEDEC tray

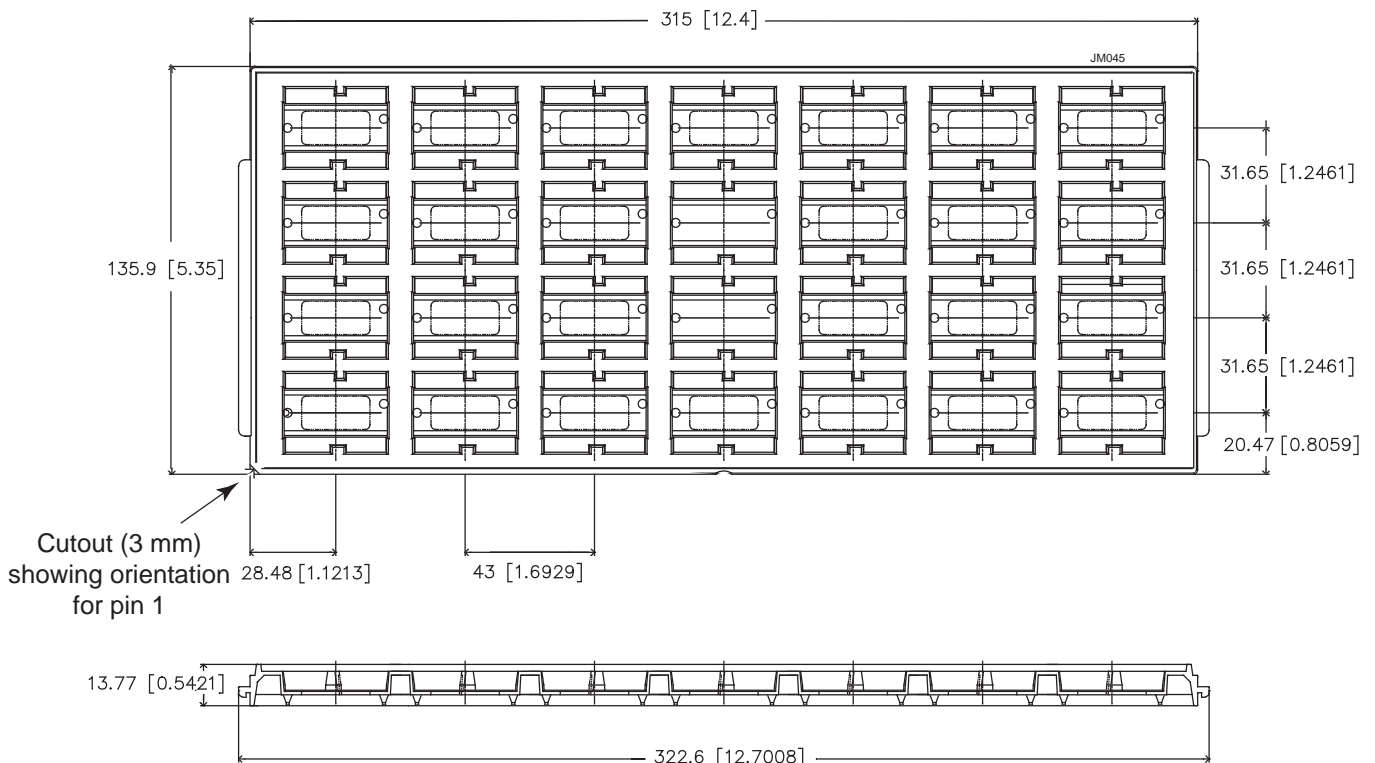

Pin Allocation

Pin	Designation	Function	Reference
1	Shutdown	Shutdown control. Pull low to turn unit off	Primary
2	-Vi	Input voltage return	Primary
3	NC	No connection	Primary
4	No Pin	No pin	
5	No Pin	No pin	
6	No Pin	No pin	
7	No Pin	No pin	
8	No Pin	No Pin	
9	NC	No connection	Secondary
10	NC	No connection	Secondary
11	NC	No connection	Secondary
12	Trim	Output voltage adjust	Secondary
13	+Vo	Positive output voltage	Secondary
14	-Vo	Output voltage return	Secondary
15	NC	No connection	Secondary
16	NC	No connection	Secondary
17	No Pin	No pin	
18	No Pin	No pin	
19	No Pin	No pin	
20	No Pin	No pin	
21	No Pin	No Pin	
22	NC	No connection	Primary
23	+Vi	Positive input voltage	Primary
24	NC	No connection	Primary

NUCLEAR AND MEDICAL APPLICATIONS - Power-One products are not designed, intended for use in, or authorized for use as critical components in life support systems, equipment used in hazardous environments, or nuclear control systems without the express written consent of the respective divisional president of Power-One, Inc.

TECHNICAL REVISIONS - The appearance of products, including safety agency certifications pictured on labels, may change depending on the date manufactured. Specifications are subject to change without notice.