

**PLEASE CHECK WWW.MOLEX.COM FOR LATEST PART INFORMATION**

**Part Number:** [0351890261](#)  
**Status:** **Planned for Obsolescence**  
**Description:** 4.75mm (.187") Tab, MP-Lock™ Housing, 2 Circuits 6.65mm (.261") Pitch, UL94V-0, Natural

**Documents:**

[3D Model](#) [Product Specification PS-35189-001 \(PDF\)](#)  
[Drawing \(PDF\)](#) [RoHS Certificate of Compliance \(PDF\)](#)

**Agency Certification**

CSA LR95446  
 UL E29179

**General**

Product Family Crimp Housings  
 Series [35189](#)  
 Product Name MP-Lock™

**Physical**

Breakaway No  
 Circuits (maximum) 2  
 Flammability 94V-2  
 Gender Female  
 Glow-Wire Compliant No  
 Keying to Mating Part None  
 Lock to Mating Part None  
 Number of Rows 2  
 Packaging Type Bag  
 Panel Mount No  
 Pitch - Mating Interface (in) 0.262 In  
 Pitch - Mating Interface (mm) 6.65 mm  
 Polarized to Mating Part Yes  
 Stackable No  
 Temperature Range - Operating -40°C to +105°C

**Electrical**

Current - Maximum per Contact 12A

**Material Info**

**Reference - Drawing Numbers**

Product Specification PS-35189-001  
 Sales Drawing SD-35189-0260

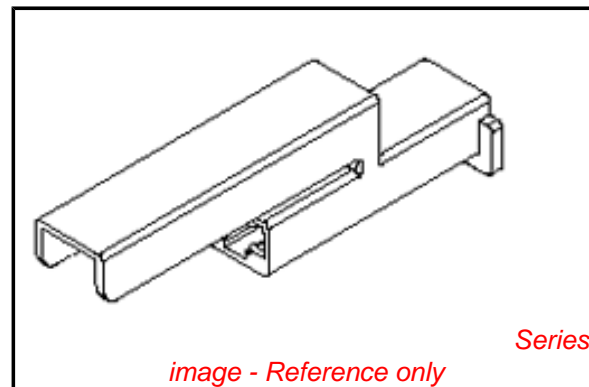

**EU RoHS**

**ELV and RoHS Compliant**  
**REACH SVHC Contains SVHC: No**  
**Halogen-Free Status**  
**Not Reviewed**

**China RoHS**



**Need more information on product environmental compliance?**

Email [productcompliance@molex.com](mailto:productcompliance@molex.com)  
 For a multiple part number RoHS Certificate of Compliance, [click here](#)

Please visit the [Contact Us](#) section for any non-product compliance questions.

**Search Parts in this Series**

[35189Series](#)

**Mates With**

Micro Switch

**Use With**

[35068](#) MP-Lock™ Quick Disconnect

ENG. NO  
SD 35189-026\*

EDP NO.

SIMILAR ITEM

PROJECT NO.  
.187 MP-LOCK CONN'

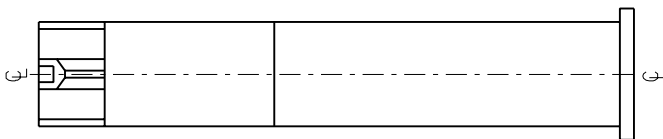
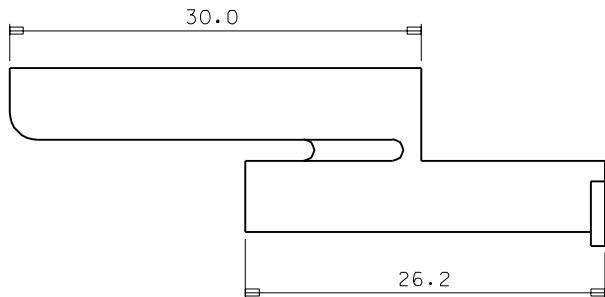
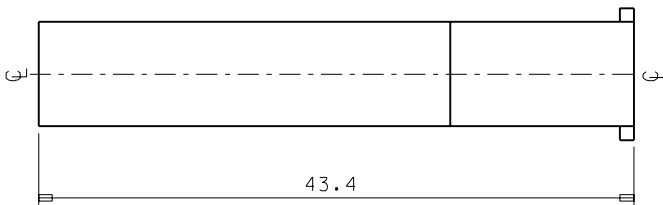
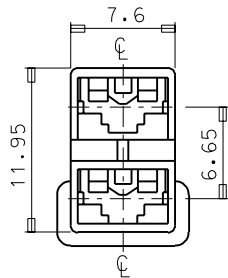
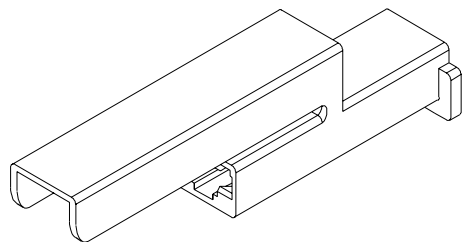

- NOTES
- MATERIAL : NYLON  
35189-0260 (UL94V-2)  
35189-0261 (UL94V-0)
  - COLOR : NATURAL
  - APPLICABLE TERMINAL : 35068-9\*\*2

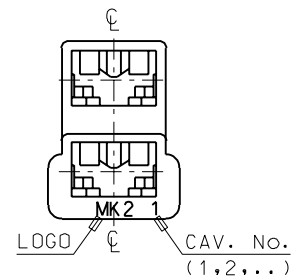

				MATERIAL SEE NOTES		MOLEX-KOREA CO.,LTD.	
				GENERAL TOLERANCE DIMENSION : ±0.3		DRAWN BY J.S.KANG	
				ANGLE : $\pm$		CHK'D BY	
B	REVISED	96-137	96-12.24	DIMENSION CLASSIFICATION		APP'D BY	
A	NEW RELEASED		96-4.17	▽ : CRITICAL ▼ : MAJOR		SCALE 3/1	
				()		TITLE :	
LTR	REVISION RECORD	ECN	DATE	ASS'Y PART DESCRIPTION		.187 MP-LOCK HSG-2P (FOR MICRO SWITCH)	
				ENG. NO.		SHEET 1 of 1	
REVISE ONLY ON CAD SYSTEM				---		ENG. NO. SD 35189-026*	
				---		REV B	