

**PLEASE CHECK WWW.MOLEX.COM FOR LATEST PART INFORMATION**

**Part Number:** **0554820339**  
**Status:** **Active**  
**Overview:** [mini\\_mi\\_ii](#)  
**Description:** 1.25mm (.049") Pitch Mini Mi II™ Wire-to-Wire Adapter, without Panel Mount Clip, 3 Circuits, Lead-free

**Documents:**

[3D Model](#) [Product Specification PS-55482-006 \(PDF\)](#)  
[Drawing \(PDF\)](#) [RoHS Certificate of Compliance \(PDF\)](#)

**General**

Product Family	Accessories
Series	<a href="#">55482</a>
Component Type	Adapter
Overview	<a href="#">mini_mi_ii</a>
Product Name	Mini Mi II™

**Physical**

Circuits (Loaded)	3
Color - Resin	Natural
Gender	Male
Material - Metal	Brass
Material - Plating Mating	Tin
Material - Plating Termination	Tin
Material - Resin	Nylon
Number of Rows	1
Packaging Type	Bag
Plating min: Mating (µin)	40
Plating min: Mating (µm)	1.00
Plating min: Termination (µin)	40
Plating min: Termination (µm)	1.00
Temperature Range - Operating	-20°C to +80°C

**Electrical**

Current - Maximum per Contact	1.5A
-------------------------------	------

**Material Info**

**Reference - Drawing Numbers**

Product Specification	PS-55482-006
Sales Drawing	SD-55482-005

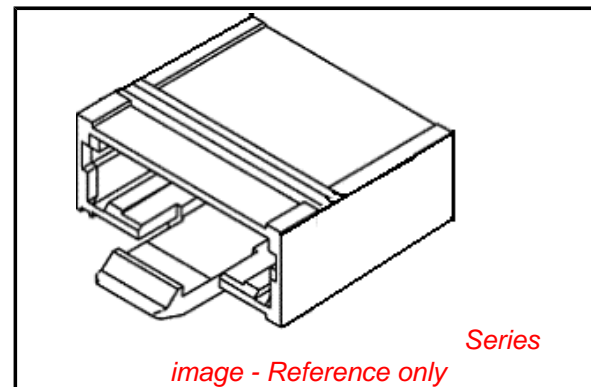

**EU RoHS**

**ELV and RoHS  
Compliant**  
**REACH SVHC  
Not Reviewed**  
**Halogen-Free  
Status**

**China RoHS**



**Need more information on product  
environmental compliance?**

Email [productcompliance@molex.com](mailto:productcompliance@molex.com)  
For a multiple part number RoHS Certificate of Compliance, [click here](#)

Please visit the [Contact Us](#) section for any non-product compliance questions.

**Search Parts in this Series**

[55482Series](#)

**Use With**

[54596 IDT Housing](#)

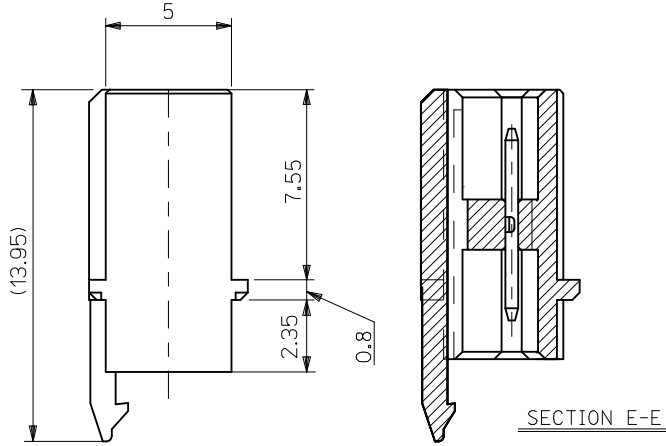
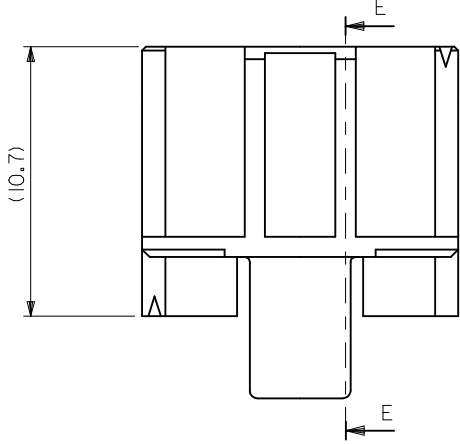
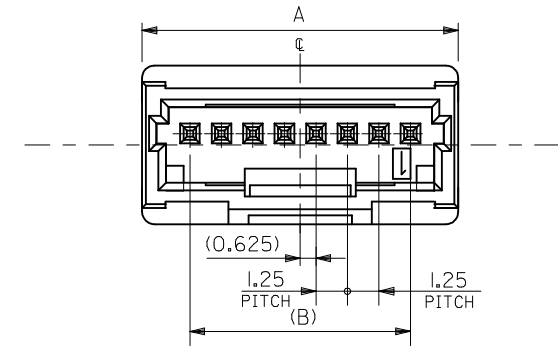

MA中継コネクタ挿入方向  
ED & MOUNTED CONNECTOR

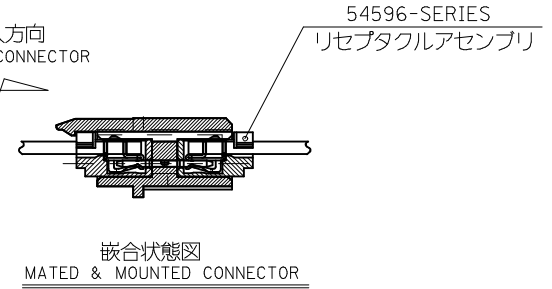

- 注記** 1.材質 MATERIAL  
 NOTES ウエハー: ポリアミド、UL94-V0、ナチュラル色  
 WAFER: PA、UL94-V0、COLOR NATURAL  
 ピン: 黄銅、銅下地 錫メッキ  
 PIN: BRASS, PRE-TINNED
- 2.嵌合相手 MATE WITH  
 リセプタクルアセンブリ: 54596 シリーズ  
 REC. ASS'Y: 54596 SERIES  
 ピン: リン青銅、錫メッキ  
 PIN: PHOSPHOR BRONZE, PRE-TINNED
- 3.本製品は 55482-\*\*\*30 の鉛フリー品である。  
 THIS PRODUCT IS LEAD FREE OF 55482-\*\*\*30.
- 4.ELV AND RoHS COMPLIANT.

23.75	27.55	55482-2039	20
22.5	26.3	55482-1939	19
21.25	25.05	55482-1839	18
20	23.8	55482-1739	17
18.75	22.55	55482-1639	16
17.5	21.3	55482-1539	15
16.25	20.05	55482-1439	14
15	18.8	55482-1339	13
13.75	17.55	55482-1239	12
12.5	16.3	55482-1139	11
11.25	15.05	55482-1039	10
10	13.8	55482-0939	9
8.75	12.55	55482-0839	8
7.5	11.3	55482-0739	7
6.25	10.05	55482-0639	6
5	8.8	55482-0539	5
3.75	7.55	55482-0439	4
2.5	6.3	55482-0339	3
1.25	5.05	55482-0239	2
B	A	TRAY	CIRCUITS

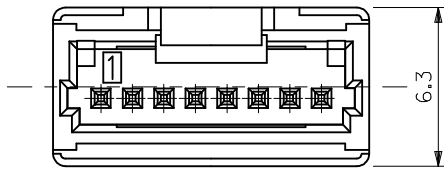

REVISED EC NO: J2010-0170 DRWN:TKON CHKD:KASAKAWA APPR:NUKITA 2009/07/27 2009/07/28 2009/07/29	DESCRIPTION 10 UNDER ±0.2 10 OVER 30 UNDER ±0.25 30 OVER ±0.3 ANGULAR ±3 ° DRAFT WHERE APPLICABLE MUST REMAIN WITHIN DIMENSIONS	GENERAL TOLERANCES (UNLESS SPECIFIED) MM ONLY		DIMENSION STYLE MM ONLY	SCALE 5:1	DESIGN UNITS METRIC	THIRD ANGLE PROJECTION
		DRAWN BY T. UENO	DATE 2004/06/07	TITLE MINI MI2 1-ROW RELAY WAFER ASSY -LEAD FREE-			
		CHECKED BY M. SASAO	DATE 2004/06/07	MOLEX INCORPORATED			
		APPROVED BY M. SASAO	DATE 2004/06/07	MATERIAL NO. SEE TABLE	DOCUMENT NO. SD-55482-005	SHEET NO. 1 OF 1	