

PLEASE CHECK WWW.MOLEX.COM FOR LATEST PART INFORMATION

Part Number: [0428789322](#)
Status: **Active**
Overview: [modular_plugs_jacks](#)
Description: Modular Jack, Vertical, Low Profile, 8/2, Keyed

Documents:

[3D Model](#) [Product Specification PS-42878 \(PDF\)](#)
[Drawing \(PDF\)](#) [RoHS Certificate of Compliance \(PDF\)](#)

Agency Certification

CSA LR19980
 UL E107635

General

Product Family Modular Jacks/Plugs
 Series [42878](#)
 Component Type PCB Jack
 Magnetic No
 Overview [modular_plugs_jacks](#)
 Performance Category 3
 Power over Ethernet (PoE) N/A
 Product Name RJ45

Physical

Boot Color N/A
 Color - Resin Black
 Durability (mating cycles max) 500
 Flammability 94V-0
 Inverted / Top Latch N/A
 Keying to Mating Part Yes
 Lightpipes/LEDs None
 Material - Metal Phosphor Bronze
 Material - Plating Mating Gold
 Material - Plating Termination Tin
 Material - Resin Polyester
 Orientation Vertical (Top Entry)
 PCB Locator Yes
 PCB Retention Yes
 PCB Thickness Recommended (in) 0.062 In
 PCB Thickness Recommended (mm) 1.57 mm
 Packaging Type Tray
 Panel Mount With Flange
 Pitch - Mating Interface (in) 0.040 In
 Pitch - Mating Interface (mm) 1.02 mm
 Pitch - Term. Interface (in) 0.050 In
 Pitch - Term. Interface (mm) 1.27 mm
 Ports 1
 Positions / Loaded Contacts 8/2
 Surface Mount Compatible (SMC) No
 Temperature Range - Operating -40°C to +85°C
 Termination Interface: Style Through Hole
 Waterproof / Dustproof No
 Wire/Cable Type N/A

Electrical

Current - Maximum per Contact 1.5A

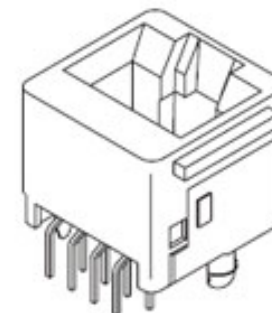

image - Reference only

Series

EU RoHS

**ELV and RoHS
 Compliant**
REACH SVHC
 Not Reviewed
**Halogen-Free
 Status**
Not Reviewed

China RoHS



**Need more information on product
 environmental compliance?**

Email productcompliance@molex.com
 For a multiple part number RoHS Certificate of
 Compliance, [click here](#)

Please visit the [Contact Us](#) section for any
 non-product compliance questions.

Search Parts in this Series

[42878Series](#)

Mates With

FCC 68 Plugs

Grounding to PCB	No
Grounding to Panel	None
Shielded	No
Voltage - Maximum	150V AC (RMS)

Solder Process Data

Duration at Max. Process Temperature (seconds)	5
Lead-free Process Capability	Wave Capable (TH only)
Max. Cycles at Max. Process Temperature	1
Process Temperature max. C	235

Material Info

Reference - Drawing Numbers

Packaging Specification	PK-42878-492
Product Specification	PS-42878
Sales Drawing	SDA-42878-****
Test Summary	TS-42878-001

This document was generated on 06/07/2010

PLEASE CHECK WWW.MOLEX.COM FOR LATEST PART INFORMATION

MODULAR JACK CHARACTERISTICS LEGEND	
EXTERNAL CONNECTOR BODY DIMENSIONS: (SEE NOTES 8 AND 9) JACKS ARE AVAILABLE IN STANDARD 4, 6, AND 8 POSITION BODY SIZES	
NUMBER OF CONTACT POSITIONS: CONNECTOR SIZE 4 CAN ACCOMMODATE 2 OR 4 TERMINALS, CONNECTOR SIZE 6 CAN ACCOMMODATE 2, 4, OR 6 TERMINALS, CONNECTOR SIZE 8 CAN ACCOMMODATE 2, 4, 6, 8, OR 10 TERMINALS	
POLARIZATION OPTION: "NO"= JACKS WITHOUT KEYING SLOT "YES"= JACKS WITH KEYING SLOT (AVAILABLE ON CONNECTOR SIZE 8 ONLY)	
MOUNTING EARS OPTION: "YES"= JACKS WITH MOUNTING EARS "NO"= JACKS WITHOUT MOUNTING EARS	

- NOTES:
- 1) MATERIALS: HOUSING- POLYESTER, GLASS FILLED, UL94V-0, COLOR - BLACK
TERMINALS- PHOSPHOR BRONZE ALLOY, .015/(0.38) THICK.
 - 2) TERMINAL PLATING:
SELECT GOLD IN CONTACT AREA: 50 MICRONS MIN.
*SELECT TIN IN PC TAIL AREA: 100 MICRONS MIN.
WITH OVERALL NICKEL UNDERPLATE: 50 MICRONS MIN.
*THE PRIMARY SHIPPING CARTON WILL BE LABELED "COMPLIANT TO ROHS DIRECTIVE 2002/95/EC AND ELV ANNEX II OF DIRECTIVE 2000/53/EC". CARTONS WITHOUT THIS LABEL MAY CONTAIN PRODUCT WITH TIN-LEAD IN THE PC TAIL.
 - 3) THESE MODULAR JACKS MEET THE PERFORMANCE REQUIREMENTS OF MOLEX PRODUCT SPECIFICATION PS-42878.
 - 4) CONNECTORS ARE SHIPPED IN THERMOFORMED TRAYS, PER PACKAGING SPECIFICATION PK-42878-492.
 - 5) ALL JACKS ARE DESIGNED TO BE USED WITH .062/(1.57) OR .125/(3.18) THICK P.C. BOARDS.
 - 6) ALL JACKS CONFORM TO AND ACCEPT PLUGS WHICH CONFORM TO FCC RULES AND REGULATIONS PART 68, SUBPART F.
 - 7) ALL JACKS MUST BE CAPABLE OF FITTING INTO MOLEX GAGE G-42410 (CONNECTOR SIZE 8).
 - 8) SEE SHEETS 1 & 4 FOR CONNECTOR SIZE 4.
 - 9) SEE SHEETS 2 & 4 FOR CONNECTOR SIZE 6.
 - 10) ENGRAVED NUMBERS ON HOUSING BODY ARE FOR MOLDING IDENTIFICATION ONLY, THEY ARE NOT INTENDED FOR ASSEMBLY IDENTIFICATION PURPOSES.
 - 11) THIS PART CONFORMS TO CLASS B REQUIREMENTS OF COSMETIC SPECIFICATION PS-45499-002 WITH THE EXCEPTION OF THE SINK WHICH CONFORMS TO CLASS C REQUIREMENTS.

P.C. BOARD THICKNESS	DIM. "D" (MTG. PEGS)	DIM. "F" (P.C. TAILS)
.062/(1.57)	.128 (3.25)	.120 +.015/-0.25 (3.05 +.38/-6.3)
.125/(3.18)	.191 (4.85)	.205 +.015/-0.25 (5.21 +.38/-6.3)

CONNECTOR SIZE	CIRCUIT SIZE	DIM. "G"
8	10	.450 (11.43)
8	8	.350 (8.89)
8	6	.250 (6.35)
8	4	.150 (3.81)
8	2	.050 (1.27)

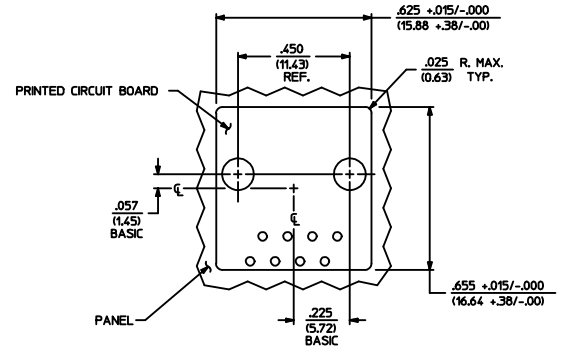
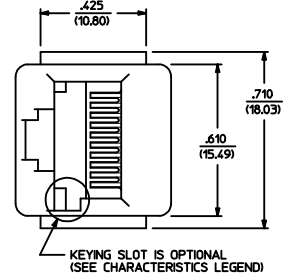

PANEL CUT-OUT FOR CONNECTOR SIZE 8

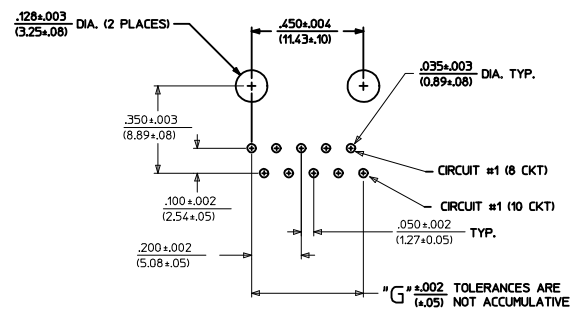
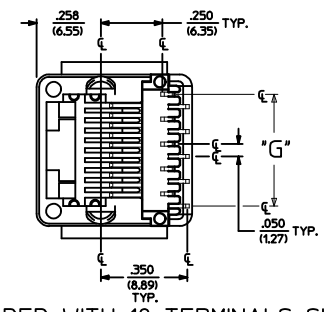
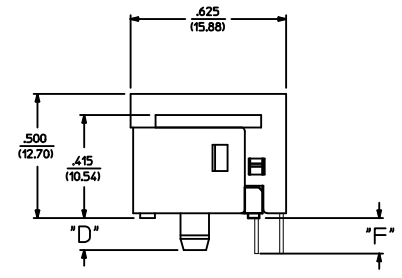
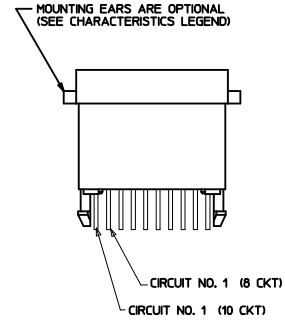

P.C. BOARD LAYOUT FOR CONNECTOR SIZE 8
10 CIRCUIT SHOWN

SIZE 8 MODULAR JACK LOADED WITH 10 TERMINALS SHOWN ABOVE

ADD COSMETIC SPEC EC NO. UCP2009-1267 H2	DRAWN: JKL/STENLER 2008/12/01 CHKD: BEL 2008/12/02 APPR: FSW/TH 2008/12/02	QUALITY SYMBOLS =0 =0	GENERAL TOLERANCES (UNLESS SPECIFIED)		DIMENSION STYLE		SCALE	DESIGN UNITS	THIRD ANGLE PROJECTION	TITLE ASSEMBLY, VERTICAL LOW PROFILE MODULAR JACKS (CONNECTOR SIZE 8)	MOLEX INCORPORATED	SHEET NO. 3 OF 5
			mm	INCH	IN/MM	1:1	INCH					
DRAWN BY			DATE		DRAWN BY		DATE		DRAWN BY			
CHECKED BY			DATE		CHECKED BY		DATE		CHECKED BY			
APPROVED BY			DATE		APPROVED BY		DATE		APPROVED BY			
MATERIAL NO.			DATE		MATERIAL NO.		DATE		MATERIAL NO.			
DRAWING NO.			DATE		DRAWING NO.		DATE		DRAWING NO.			
DRAFT WHERE APPLICABLE MUST REMAIN WITHIN DIMENSIONS			SEE SHEET 5		DRAFT WHERE APPLICABLE MUST REMAIN WITHIN DIMENSIONS		SEE SHEET 5		DRAFT WHERE APPLICABLE MUST REMAIN WITHIN DIMENSIONS			
SIZE D			THIS DRAWING CONTAINS INFORMATION THAT IS PROPRIETARY TO MOLEX INCORPORATED AND SHOULD NOT BE USED WITHOUT WRITTEN PERMISSION		SIZE D		THIS DRAWING CONTAINS INFORMATION THAT IS PROPRIETARY TO MOLEX INCORPORATED AND SHOULD NOT BE USED WITHOUT WRITTEN PERMISSION		SIZE D			

*X=NOT TOOLED	PART CHARACTERISTICS						*X=NOT TOOLED	PART CHARACTERISTICS						*X=NOT TOOLED			
	ASSEMBLY ITEM NUMBER	EXTERNAL CONNECTOR SIZE	NUMBER OF POSITIONS	P. C. BOARD THICKNESS	POLARIZATION OPTION	MOUNTING EARS OPTION		ASSEMBLY ITEM NUMBER	EXTERNAL CONNECTOR SIZE	NUMBER OF POSITIONS	BOARD THICKNESS/P.C. TAIL OPTION	POLARIZATION OPTION	MOUNTING EARS OPTION		ASSEMBLY ITEM NUMBER	EXTERNAL CONNECTOR SIZE	NUMBER OF POSITIONS
42878-8408	8 POS. BODY	8	.062	NO	YES	42878-8984	8 POS. BODY	4	.062	NO	YES	42878-1001	8 POS. BODY	10	.062	NO	YES
42878-8410	↑	↑	↑	NO	NO	42878-8986	↑	↑	↑	NO	NO	42878-1003	↑	↑	.062	NO	NO
42878-8456	↓	↓	↓	YES	YES	42878-9032	↓	↓	↓	YES	YES	42878-1025	↓	↓	.125	NO	YES
42878-8458			.062	YES	NO	42878-9034			.062	YES	NO	42878-1027				NO	NO
42878-8504			.125	NO	YES	42878-9080			.125	NO	YES	42878-1037	↓	↓	↓	YES	YES
42878-8506			↑	NO	NO	42878-9082			↑	NO	NO	42878-1039	8 POS. BODY	10	.125	YES	NO
42878-8552		↓	↑	YES	YES	42878-9128	↓	↓	↓	YES	YES						
42878-8554		8	.125	YES	NO	42878-9130		4	.125	YES	NO						
42878-8696		6	.062	NO	YES	42878-9272		2	.062	NO	YES						
42878-8698		↑	↑	NO	NO	42878-9274		↑	↑	NO	NO						
42878-8744		↓	↓	YES	YES	42878-9320		↓	↓	YES	YES						
42878-8746			.062	YES	NO	42878-9322			.062	YES	NO						
42878-8792			.125	NO	YES	42878-9368			.125	NO	YES						
42878-8794		↑	↑	NO	NO	42878-9370		↑	↑	NO	NO						
42878-8840	↓	↓	↓	YES	YES	42878-9416	↓	↓	↓	YES	YES						
42878-8842	8 POS. BODY	6	.125	YES	NO	42878-9418	8 POS. BODY	2	.125	YES	NO						

CHARACTERISTICS LEGEND	
EXTERNAL CONNECTOR BODY DIMENSIONS: AVAILABLE IN 4, 6, AND 8 POSITION BODY	
NUMBER OF CONTACT POSITIONS: CONNECTOR SIZE 4 ACCOMMODATES 2, OR 4 TERMINALS, CONNECTOR SIZE 6 ACCOMMODATES 2, 4, OR 6 TERMINALS, CONNECTOR SIZE 8 ACCOMMODATES 2, 4, 6, 8, OR 10 TERMINALS	
POLARIZATION OPTION: (AVAILABLE ON CONNECTOR SIZE 8 ONLY) "NO" - WITHOUT KEYING SLOT "YES" - WITH KEYING SLOT	
MOUNTING EARS OPTION: "YES" - PART WITH MOUNTING EARS "NO" - PART WITHOUT MOUNTING EARS	
(SEE SHEET 3 FOR PART DESCRIPTIONS AND DIMENSIONS)	

SEE SHEET ONE EC NO: UCP2004-667 DRW:LSCHMIDT 2004/03/03 CHK:LSCHMIDT 2004/03/03 APPR:ESMITH 2004/03/03	QUALITY SYMBOLS	GENERAL TOLERANCES (UNLESS SPECIFIED)	SCALE	DESIGN UNITS	THIRD ANGLE PROJECTION	REVISE ON CAD ONLY
	▽ 0	mm INCH	---	INCH	ASSEMBLY, VERTICAL LOW PROFILE MODULAR JACKS (CONNECTOR SIZE 8)	
	▽ 0	4 PLACES ± --- ± --- 3 PLACES ± --- ± --- 2 PLACES ± --- ± --- 1 PLACE ± --- ± ---	IN/MM	DRAWN BY DATE BAP 1992/04/09	MATERIAL NO. DOCUMENT NO. SHEET NO. MOLEX INCORPORATED SEE CHART SDA-42878-**** 5 OF 5	
		ANGULAR ±1/2° DRAFT WHERE APPLICABLE MUST REMAIN WITHIN DIMENSIONS		CHECKED BY DATE BAP 1992/04/09	THIS DRAWING CONTAINS INFORMATION THAT IS PROPRIETARY TO MOLEX INCORPORATED AND SHOULD NOT BE USED WITHOUT WRITTEN PERMISSION	