

Features

- Epitaxial Planar Die Construction
- Ideally Suited for Automated Assembly Processes
- Ideal for Medium Power Switching or Amplification Applications
- **Lead Free By Design/RoHS Compliant (Note 1)**
- **"Green" Device (Note 2)**

Mechanical Data

- Case: SOT-223
- Case Material: Molded Plastic, "Green" Molding Compound. UL Flammability Classification Rating 94V-0
- Moisture Sensitivity: Level 1 per J-STD-020C
- Terminals: Finish — Matte Tin annealed over Copper Leadframe (Lead Free Plating). Solderable per MIL-STD-202, Method 208
- Marking Information: See Page 3
- Ordering Information: See Page 3
- Weight: 0.115 grams (approximate)

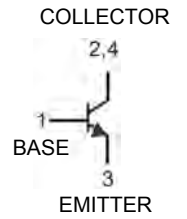
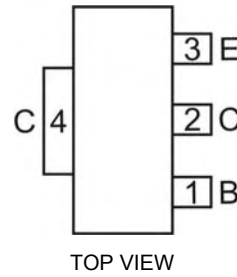

Schematic and Pin Configuration

Maximum Ratings @T_A = 25°C unless otherwise specified

Characteristic	Symbol	Value	Unit
Collector-Base Voltage	V _{CBO}	50	V
Collector-Emitter Voltage	V _{CEO}	25	V
Emitter-Base Voltage	V _{EBO}	7.0	V
Collector Current	I _C	5.0	A
Base Current	I _B	1.0	A
Power Dissipation	P _D	1 (Note 3) 2 (Note 4)	W
Thermal Resistance, Junction-to-Ambient	R _{θJA}	125 (Note 3) 62.5 (Note 4)	°C/W
Operating and Storage Temperature Range	T _j , T _{STG}	-65 to +150	°C

- Notes:
1. No purposefully added lead.
 2. Diodes Inc.'s "Green" policy can be found on our website at http://www.diodes.com/products/lead_free/index.php.
 3. Device mounted on FR-4 PCB, pad layout as shown on page 4.
 4. Device mounted on Polyimide PCB with a copper area of 1.8cm².

Electrical Characteristics @T_A = 25°C unless otherwise specified

Characteristic	Symbol	Min	Typ	Max	Unit	Test Condition
OFF CHARACTERISTICS						
Collector-Emitter Breakdown Voltage	V _{(BR)CEO}	25	—	—	V	I _C = 10mA, I _B = 0
Collector Cutoff Current	I _{CBO}	—	—	1.0	μA	V _{CB} = 50V, I _E = 0
Emitter Cutoff Current	I _{EBO}	—	—	1.0	μA	V _{EB} = 7.0V, I _C = 0
ON CHARACTERISTICS						
Collector-Emitter Saturation Voltage	V _{CE(SAT)}	—	—	0.35 0.50	V	I _C = 3.0A, I _B = 150mA* I _C = 4.0A, I _B = 200mA*
Base-Emitter Saturation Voltage	V _{BE(SAT)}	—	—	1.10 1.40	V	I _C = 3.0A, I _B = 150mA* I _C = 4.0A, I _B = 200mA*
DC Current Gain	h _{FE}	250 150 50	—	500 — —	—	I _C = 500mA, V _{CE} = 2.0V* I _C = 2.0A, V _{CE} = 2.0V* I _C = 5.0A, V _{CE} = 2.0V*
SMALL SIGNAL CHARACTERISTICS						
Current Gain-Bandwidth Product	f _T	—	150	—	MHz	I _C = 50mA, V _{CE} = 6.0V, f = 200MHz
Output Capacitance	C _{obo}	—	—	50	pF	V _{CB} = 10V, I _E = 0, f = 1MHz

* Measured under pulsed conditions. Pulse width = 300μs. Duty cycle ≤2%

Typical Characteristics @T_{amb} = 25°C unless otherwise specified

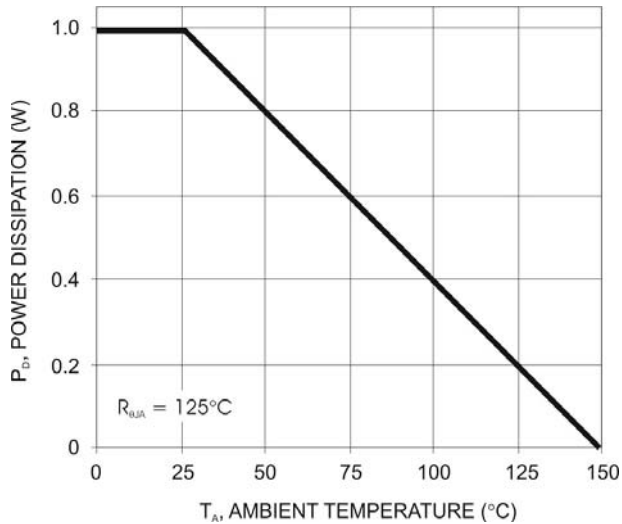

Fig. 1 Power Dissipation vs. Ambient Temperature (Note 3)

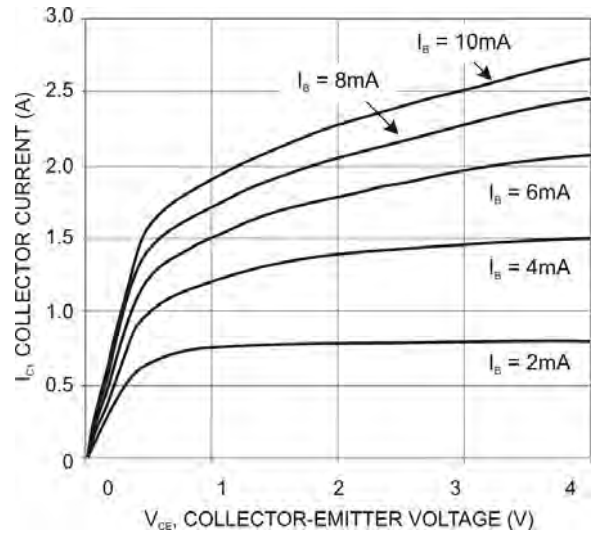

Fig. 2 Collector Current vs. Collector Emitter-Voltage

Notes: 3. Device mounted on FR-4 PCB, pad layout as shown on page 4.

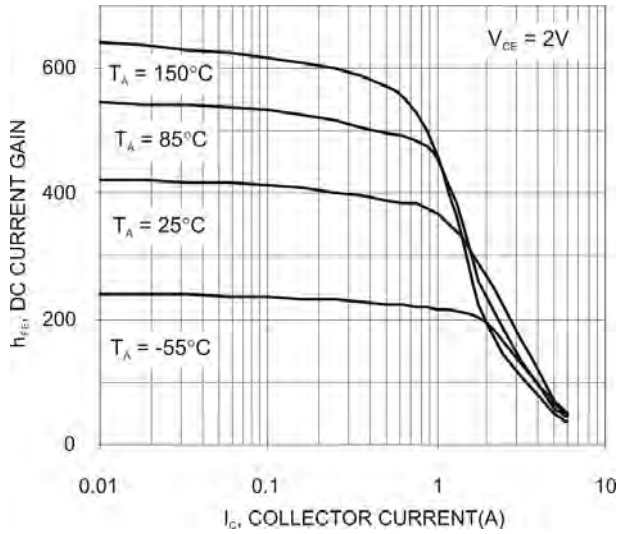

Fig. 3 Typical DC Current Gain vs. Collector Current

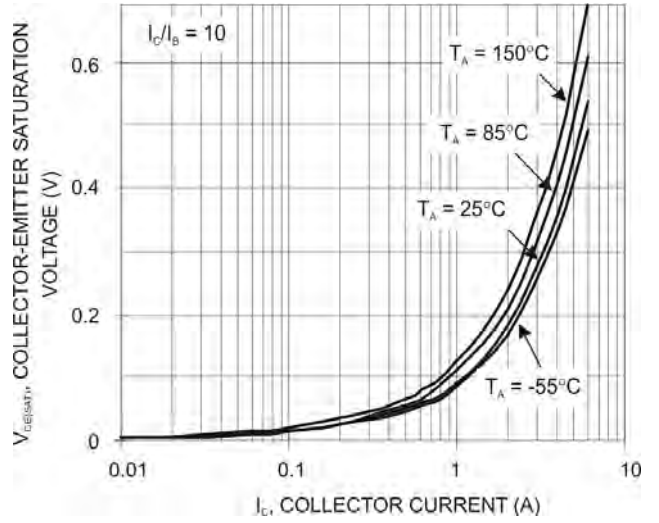

Fig. 4 Collector-Emitter Saturation Voltage vs. Collector Current

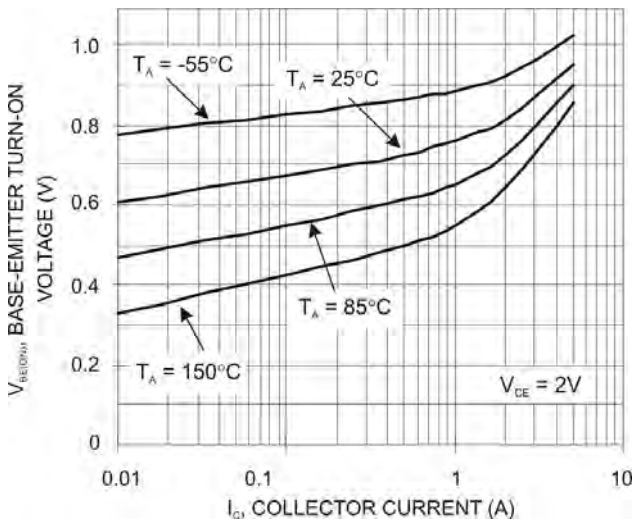

Fig. 5 Base-Emitter Turn-On Voltage vs. Collector Current

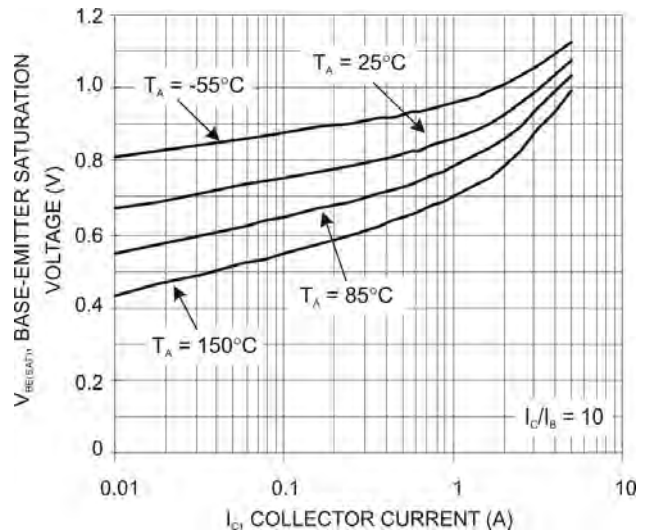

Fig. 6 Base-Emitter Saturation Voltage vs. Collector Current

Ordering Information (Note 5)

Device	Packaging	Shipping
DZT3150-13	SOT-223	2500/Tape & Reel

Notes: 5. Packaging Details as shown on page 4, or go to our website at <http://www.diodes.com/ap2007.pdf>.

Marking Information

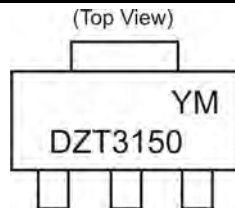

DZT3150 = Product Type Marking Code
 YM = Date Code Marking
 Y = Year ex: T = 2006
 M = Month ex: 9 = September

Date Code Key

Year	2006	2007	2008	2009	2010	2011	2012					
Code	T	U	V	W	X	Y	Z					
Month	Jan	Feb	Mar	Apr	May	Jun	Jul	Aug	Sep	Oct	Nov	Dec
Code	1	2	3	4	5	6	7	8	9	O	N	D

Package Outline Dimensions

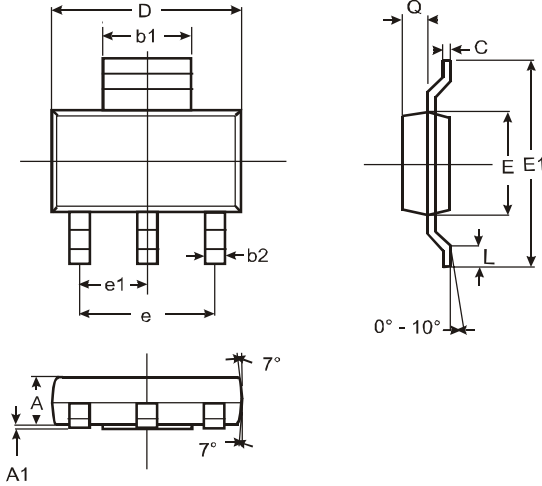

SOT-223			
Dim	Min	Max	Typ
A	1.55	1.65	1.60
A1	0.010	0.15	0.05
b1	2.90	3.10	3.00
b2	0.60	0.80	0.70
C	0.20	0.30	0.25
D	6.45	6.55	6.50
E	3.45	3.55	3.50
E1	6.90	7.10	7.00
e	—	—	4.60
e1	—	—	2.30
L	0.85	1.05	0.95
Q	0.84	0.94	0.89
All Dimensions in mm			

Suggested Pad Layout: (Based on IPC-SM-782)

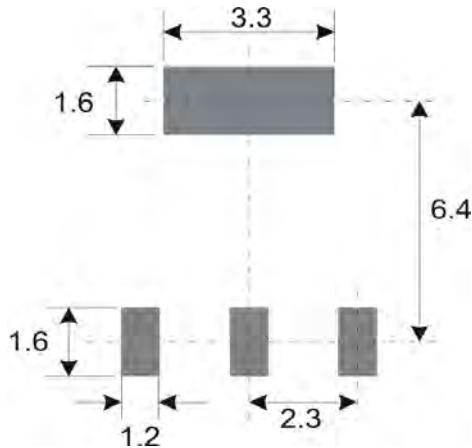

(Unit:mm)

IMPORTANT NOTICE

Diodes Incorporated and its subsidiaries reserve the right to make modifications, enhancements, improvements, corrections or other changes without further notice to any product herein. Diodes Incorporated does not assume any liability arising out of the application or use of any product described herein; neither does it convey any license under its patent rights, nor the rights of others. The user of products in such applications shall assume all risks of such use and will agree to hold Diodes Incorporated and all the companies whose products are represented on our website, harmless against all damages.

LIFE SUPPORT

Diodes Incorporated products are not authorized for use as critical components in life support devices or systems without the expressed written approval of the President of Diodes Incorporated.