

Silicon NPN Power Transistors

2SC3423

DESCRIPTION

- With TO-126 package
- Complement to type 2SA1360
- High transition frequency

APPLICATIONS

- Audio frequency amplifier applications

PINNING

PIN	DESCRIPTION
1	Emitter
2	Collector;connected to mounting base
3	Base

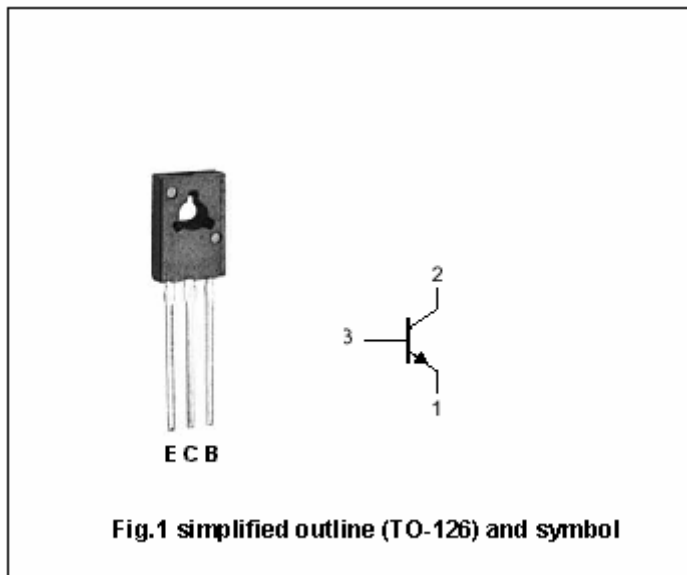

Absolute maximum ratings(Ta=25°C)

SYMBOL	PARAMETER	CONDITIONS	VALUE	UNIT
V <sub>CB0</sub>	Collector-base voltage	Open emitter	150	V
V <sub>CEO</sub>	Collector-emitter voltage	Open base	150	V
V <sub>EBO</sub>	Emitter-base voltage	Open collector	5	V
I <sub>C</sub>	Collector current		50	mA
I <sub>B</sub>	Base current		5	mA
P <sub>D</sub>	Total power dissipation	T <sub>a</sub> =25°C	1.2	W
		T <sub>C</sub> =25°C	5	
T <sub>j</sub>	Junction temperature		150	°C
T <sub>stg</sub>	Storage temperature		-55°C+150	°C

## Silicon NPN Power Transistors

## 2SC3423

## CHARACTERISTICS

T<sub>j</sub>=25 °C unless otherwise specified

SYMBOL	PARAMETER	CONDITIONS	MIN	TYP.	MAX	UNIT
V <sub>(BR)CEO</sub>	Collector-emitter breakdown voltage	I <sub>C</sub> =1mA ; I <sub>B</sub> =0	150			V
V <sub>CEsat</sub>	Collector-emitter saturation voltage	I <sub>C</sub> =10mA; I <sub>B</sub> =1mA			1.0	V
V <sub>BE</sub>	Base-emitter on voltage	I <sub>C</sub> =10mA ; V <sub>CE</sub> =5V			0.8	V
I <sub>CBO</sub>	Collector cut-off current	V <sub>CB</sub> =150V; I <sub>E</sub> =0			0.1	μA
I <sub>EBO</sub>	Emitter cut-off current	V <sub>EB</sub> =5V; I <sub>C</sub> =0			0.1	μA
h <sub>FE</sub>	DC current gain	I <sub>C</sub> =10mA ; V <sub>CE</sub> =5V	80		240	
C <sub>ob</sub>	Output capacitance	I <sub>E</sub> =0 ; V <sub>CB</sub> =10V f=1MHz		1.8		pF
f <sub>T</sub>	Transition frequency	I <sub>C</sub> =10mA ; V <sub>CE</sub> =5V		200		MHz

◆ h<sub>FE</sub> Classifications

O	Y
80-160	120-240

Silicon NPN Power Transistors

2SC3423

PACKAGE OUTLINE

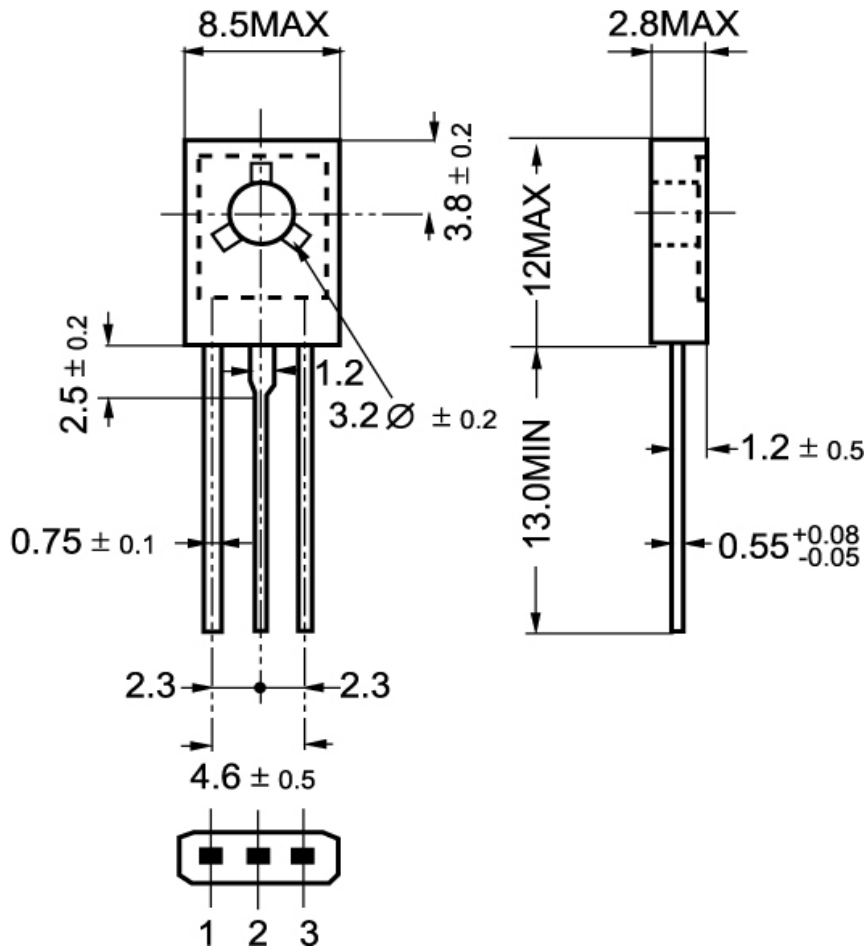

Fig.2 Outline dimensions

Silicon NPN Power Transistors

2SC3423

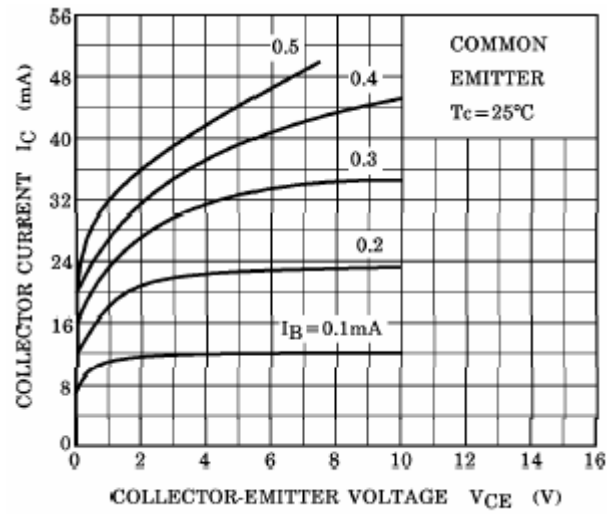

Fig.3 Static Characteristic

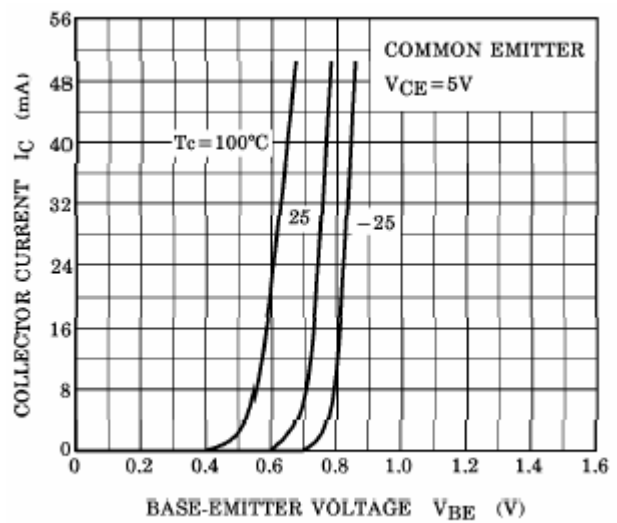

Fig.4  $I_C - V_{BE}$

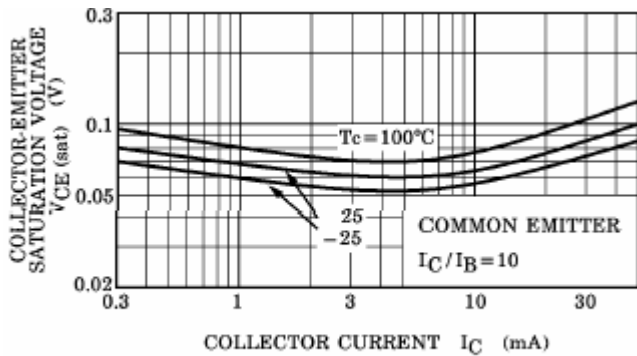

Fig.5 Collector-Emitter Saturation Voltage

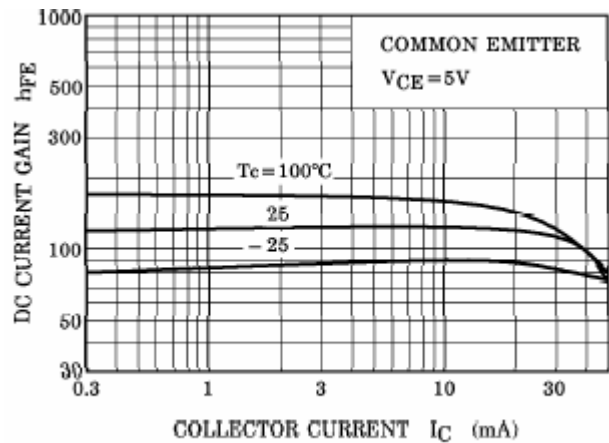

Fig.6 DC current Gain

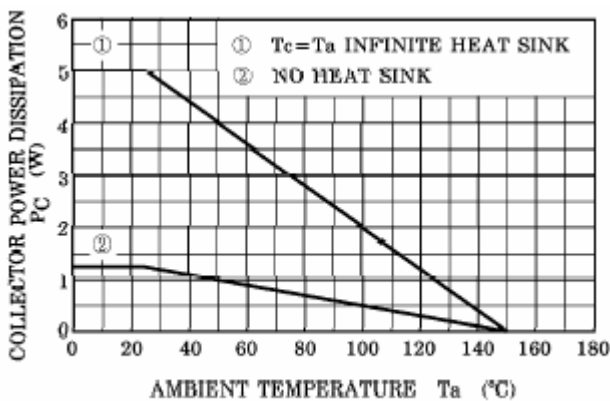

Fig.7 Power Derating