



UM23C1024

131,072 × 8-BIT CMOS MASK-PROGRAMMABLE ROM

Mask ROM

Features

- 131,072 x 8-bit organization
- Single +5V power supply
- Access times: 150/200 ns (max.)
- Current:
 - Operating: 40 mA (max.)
 - Standby: 30 μ A (max.)
- 3-state outputs for wired-OR expansion
- Mask programmed for Chip Enable (Powerdown) CE/ $\overline{\text{CE}}$ or Chip Select CS/ $\overline{\text{CS}}$
- Fully static operation
- TTL-compatible inputs and outputs
- Available in 28 pin DIP package (UM23C1024) or in 28 pin SOP package (UM23C1024M)

General Description

The UM23C1024 high-performance Read Only Memory is organized 131,072 words by 8 bits. It is designed to be compatible with all microprocessors and similar applications where high-performance large-bit storage and simple interfacing are important design considerations.

The UM23C1024 offers automatic powerdown controlled by the Chip Enable CE/ $\overline{\text{CE}}$ input. When CE/ $\overline{\text{CE}}$ goes LOW/HIGH, the device will automatically power down and remain in a low power standby mode as long as CE/ $\overline{\text{CE}}$ remains LOW/HIGH. Pin 20 may also be mask programmed as CS/ $\overline{\text{CS}}$ (active HIGH or LOW) in order to eliminate bus contention in multiple bus microprocessor systems.

Pin Configuration

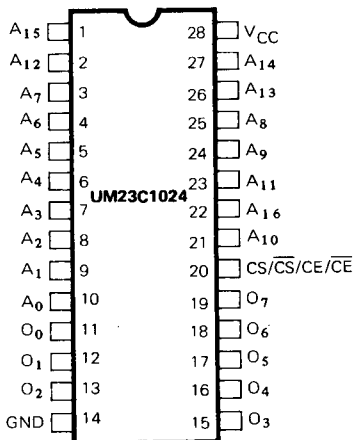

Block Diagram

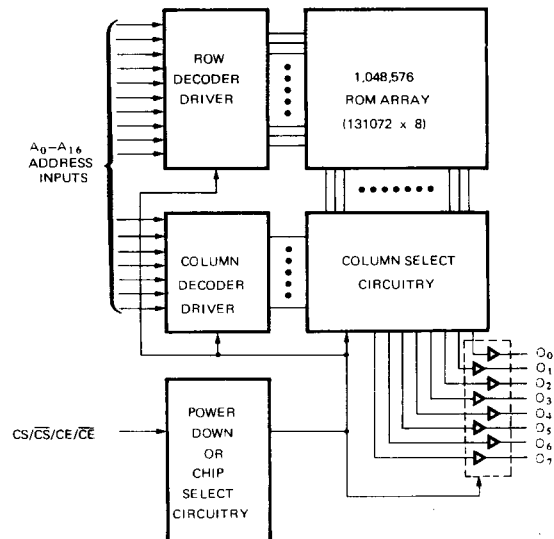



Pin Description

Pin No.	Symbol	Description
1-10, 21-27	A ₀ – A ₁₆	Address Input
11-13, 15-19	O ₀ ~ O ₇	Data Output
14	GND	Ground
28	V _{CC}	Power supply
20	CS/ $\overline{\text{CS}}$ /CE/ $\overline{\text{CE}}$	Chip Select/Chip Enable Input

Recommended DC Operating Conditions

(T_A = 0°C to +70°C)

Symbol	Parameter	Min.	Typ.	Max.	Unit
V _{CC}	Supply Voltage	4.5	5.0	5.5	V
GND	Supply Voltage	0	0	0	V
V _{IH}	Input High Voltage	2.2		V _{CC} +0.3	V
V _{IL}	Input Low Voltage	-0.5	0	0.8	V

Absolute Maximum Ratings *

Ambient Operating Temperature -10 to +80°C
 Storage Temperature -65 to +150°C
 Supply Voltage to Ground Potential -0.5 to +7.0V
 Output Voltage -0.5 to V_{CC} + 0.5V
 Input Voltage -0.5 to V_{CC} + 0.5V
 Power Dissipation 300 mW
 Soldering Temp. & Time 260°C, 10 sec

*Comments

Stresses above those listed under "Absolute Maximum Ratings" may cause permanent damage to the device. These are stress ratings only. Functional operation of this device at these or any other conditions above those indicated in the operational sections of this specification is not implied and exposure to absolute maximum rating conditions for extended periods may affect device reliability.

DC Electrical Characteristics (T_A = 0°C to +70°C, V_{CC} = 5.0V ± 10%, GND = 0V)

Symbol	Parameter	Min.	Typ.	Max.	Unit	Test Conditions	Note
V _{OH}	Output HIGH Voltage	2.4		V _{CC}	V	I _{OH} = -1.0 mA	
V _{OL}	Output LOW Voltage			0.4	V	I _{OL} = 3.2 mA	
V _{IH}	Input HIGH Voltage	2.2		V _{CC} +0.3	V		
V _{IL}	Input LOW Voltage	-0.5		0.8	V		
I _{LI}	Input Leakage Current			10	μA	V _{IN} = 0V to V _{CC}	
I _{LO}	Output Leakage Current			10	μA	V _{OUT} = 0V to V _{CC}	1
I _{CC}	Operating Supply Current			40	mA		2
I _{SB}	Standby Supply Current			1.0	mA	$\overline{\text{CE}} = V_{IH}, \text{CE} = V_{IL}$	
I _{SB1}	Standby Supply Current			30	μA	$\overline{\text{CE}} = V_{CC} - 0.2V, \text{CE} = 0.2V$	

Capacitance:

Symbol	Parameter	Min.	Max.	Unit	Test Conditions	Note
C _I	Input Capacitance		10	pF	T _A = 25°C f = 1.0 MHz	3
C _O	Output Capacitance		10	pF		

AC Characteristics ($T_A = 0^\circ\text{C}$ to $+70^\circ\text{C}$, $V_{CC} = 5.0\text{V} \pm 10\%$, $\text{GND} = 0\text{V}$)

Symbol	Parameter	UM23C1024-15		UM23C1024-20		Unit	Note
		Min.	Max.	Min.	Max.		
t_{CYC}	Cycle Time	150		200		ns	
t_{AA}	Address Access Time		150		200	ns	
t_{ACE}	Chip Enable Access Time		150		200	ns	
t_{ACS}	Chip Select Access Time		85		100	ns	
t_{OH}	Output Hold After Address Change	10		10		ns	
t_{LZ}	Output LOW Z Delay	10		10		ns	4
t_{HZ}	Output HIGH Z Delay		85		100	ns	5
t_{PU}	Power-Up Time	0		0		ns	
t_{PD}	Powerdown Time		85		100	ns	

Notes:

1. $\text{CS}/\overline{\text{CE}} = V_{IL}$, $\overline{\text{CS}}/\overline{\text{CE}} = V_{IH}$ (Output is unloaded)
2. $V_{IN} = V_{IH}/V_{IL}$, But $\text{CS}/\overline{\text{CE}} = V_{IH}$, $\overline{\text{CS}}/\overline{\text{CE}} = V_{IL}$ (Output is unloaded)
3. This parameter is periodically sampled and is not 100% tested. All pins except pin under test tied to AC ground.
4. Output LOW impedance delay (t_{LZ}) is measured from $\text{CE}/\overline{\text{CE}}$ or $\text{CS}/\overline{\text{CS}}$ going active.
5. Output HIGH impedance delay (t_{HZ}) is measured from $\text{CE}/\overline{\text{CE}}$ or $\text{CS}/\overline{\text{CS}}$ going inactive.

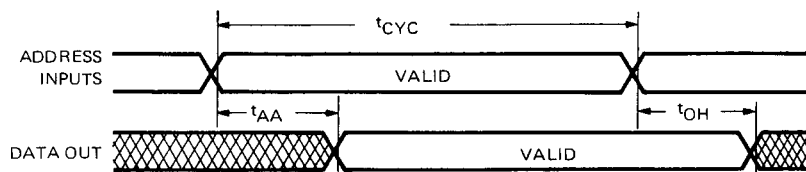
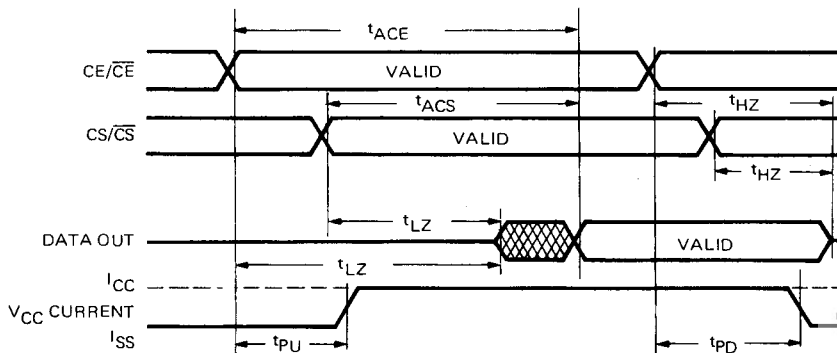
Timing Waveforms**PROPAGATION DELAY FROM ADDRESS ($\text{CE}/\overline{\text{CE}} = \text{ACTIVE}$, $\text{CS}/\overline{\text{CS}} = \text{ACTIVE}$)****PROPAGATION DELAY FROM CHIP ENABLE, OR CHIP SELECT (ADDRESS VALID)**



AC Test Conditions

Input Pulse Levels	0.4 – 2.4V
Input Rise and Fall Times	10ns
Timing Measurement Reference Level	$V_{IL} = 0.8V$ $V_{IH} = 2.2V$ $V_{OL} = 0.8V$ $V_{OH} = 2.0V$
Output Load	See Figure 1

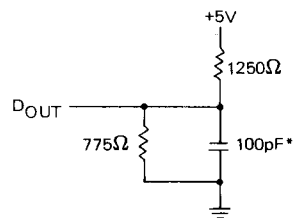

* Including scope and jig

Figure 1 Output Load Circuit

Characteristic Curves

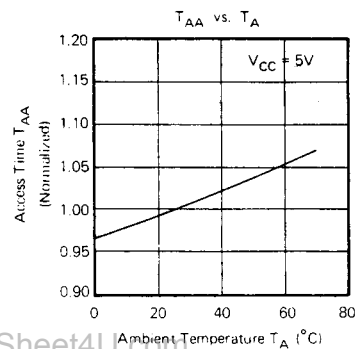
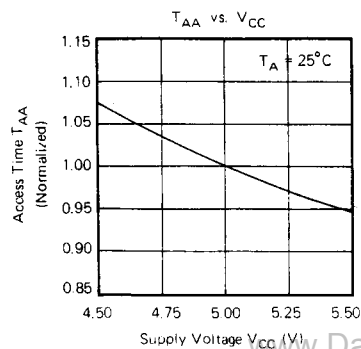
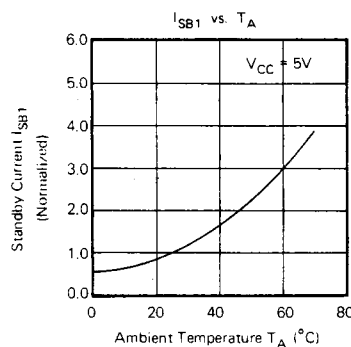
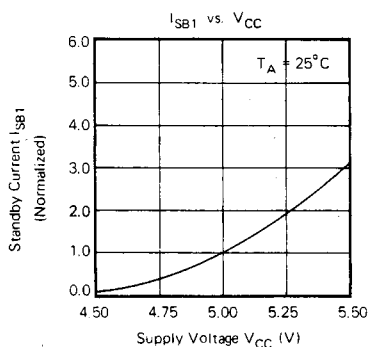
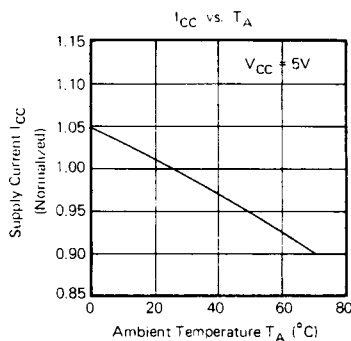
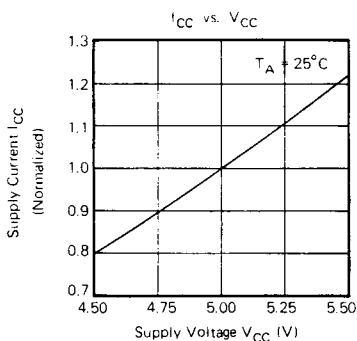

www.DataSheet4U.com

**Ordering Information**

Part No.	Access Time (ns)	Operating Current Max. (mA)	Standby Current Max. (mA)	Package
UM23C1024-15	150	40	0.03	28L DIP
UM23C1024M-15				28L SOP
UM23C1024-20	200	40	0.03	28L DIP
UM23C1024M-20				28L SOP

Mask ROM