

**Features**

- Complementary Pair
- Epitaxial Planar Die Construction
- One 2222A Type (NPN),  
One 2907A Type (PNP)
- Ideal for Low Power Amplification and Switching
- **Lead Free By Design/RoHS Compliant (Note 2)**
- **"Green Device" (Note 3)**

**Mechanical Data**

- Case: SOT-26
- Case Material: Molded Plastic, "Green" Molding Compound. UL Flammability Classification Rating 94V-0
- Moisture Sensitivity: Level 1 per J-STD-020C
- Terminals: Finish - Matte Tin annealed over Copper leadframe. Solderable per MIL-STD-202, Method 208
- Terminal Connections: See Diagram
- Ordering & Date Code Information: See Page 6
- Marking Information: See Page 6
- Weight: 0.006 grams (approximate)

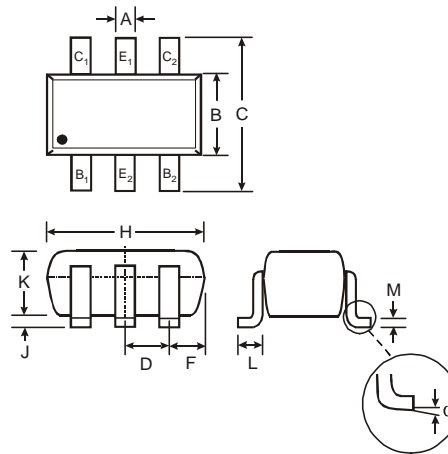

Note: E1, B1, and C1 = 2222A Type (NPN)  
E2, B2, and C2 = 2907A Type (PNP)  
Type marking indicates orientation

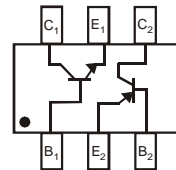

SOT-26			
Dim	Min	Max	Typ
A	0.35	0.50	0.38
B	1.50	1.70	1.60
C	2.70	3.00	2.80
D	-	-	0.95
F	-	-	0.55
H	2.90	3.10	3.00
J	0.013	0.10	0.05
K	1.00	1.30	1.10
L	0.35	0.55	0.40
M	0.10	0.20	0.15
$\alpha$	0°	8°	-
<b>All Dimensions in mm</b>			

**Maximum Ratings: 2222A Type (NPN)** @T<sub>A</sub> = 25°C unless otherwise specified

Characteristic	Symbol	2222A (NPN)	Unit
Collector-Base Voltage	V <sub>CB0</sub>	75	V
Collector-Emitter Voltage	V <sub>CEO</sub>	40	V
Emitter-Base Voltage	V <sub>EBO</sub>	6.0	V
Collector Current - Continuous	I <sub>C</sub>	600	mA

**Maximum Ratings: 2907A Type (PNP)** @T<sub>A</sub> = 25°C unless otherwise specified

Characteristic	Symbol	2907A (PNP)	Unit
Collector-Base Voltage	V <sub>CB0</sub>	-60	V
Collector-Emitter Voltage	V <sub>CEO</sub>	-60	V
Emitter-Base Voltage	V <sub>EBO</sub>	-5.0	V
Collector Current - Continuous	I <sub>C</sub>	-600	mA

**Maximum Ratings: Total** @T<sub>A</sub> = 25°C unless otherwise specified

Characteristic	Symbol	Value	Unit
Power Dissipation (Note 1)	P <sub>D</sub>	300	mW
Thermal Resistance, Junction to Ambient (Note 1)	R <sub>θJA</sub>	417	°C/W
Operating and Storage Temperature Range	T <sub>j</sub> , T <sub>STG</sub>	-55 to +150	°C

- Notes:
1. Device mounted on FR-4 PCB, 1 inch x 0.85 inch x 0.062 inch; pad layout as shown on Diodes Inc. suggested pad layout document AP02001, which can be found on our website at <http://www.diodes.com/datasheets/ap02001.pdf>.
  2. No purposefully added lead.
  3. Diodes Inc.'s "Green" policy can be found on our website at [http://www.diodes.com/products/lead\\_free/index.php](http://www.diodes.com/products/lead_free/index.php).

NEW PRODUCT

**Electrical Characteristics: 2222A Type (NPN)** @ $T_A = 25^\circ\text{C}$  unless otherwise specified

Characteristic	Symbol	Min	Max	Unit	Test Condition	
<b>OFF CHARACTERISTICS (Note 4)</b>						
Collector-Base Breakdown Voltage	$V_{(BR)CBO}$	75	—	V	$I_C = 10\mu\text{A}, I_E = 0$	
Collector-Emitter Breakdown Voltage	$V_{(BR)CEO}$	40	—	V	$I_C = 10\text{mA}, I_B = 0$	
Emitter-Base Breakdown Voltage	$V_{(BR)EBO}$	6.0	—	V	$I_E = 10\mu\text{A}, I_C = 0$	
Collector Cutoff Current	$I_{CBO}$	—	10	nA	$V_{CB} = 60\text{V}, I_E = 0$	
Collector Cutoff Current	$I_{CEX}$	—	10	nA	$V_{CE} = 60\text{V}, V_{EB(OFF)} = 3.0\text{V}$	
Emitter Cutoff Current	$I_{EBO}$	—	10	nA	$V_{EB} = 3.0\text{V}, I_C = 0$	
Base Cutoff Current	$I_{BL}$	—	20	nA	$V_{CE} = 60\text{V}, V_{EB(OFF)} = 3.0\text{V}$	
<b>ON CHARACTERISTICS (Note 4)</b>						
DC Current Gain	$h_{FE}$	35	—	—	$I_C = 100\mu\text{A}, V_{CE} = 10\text{V}$	
		50	—			$I_C = 1.0\text{mA}, V_{CE} = 10\text{V}$
		75	—			$I_C = 10\text{mA}, V_{CE} = 10\text{V}$
		100	300			$I_C = 150\text{mA}, V_{CE} = 10\text{V}$
		40	—			$I_C = 500\text{mA}, V_{CE} = 10\text{V}$
		50	—			$I_C = 10\text{mA}, V_{CE} = 10\text{V}, T_A = -55^\circ\text{C}$
35	—	$I_C = 150\text{mA}, V_{CE} = 1.0\text{V}$				
Collector-Emitter Saturation Voltage	$V_{CE(SAT)}$	—	0.3 1.0	V	$I_C = 150\text{mA}, I_B = 15\text{mA}$ $I_C = 500\text{mA}, I_B = 50\text{mA}$	
Base-Emitter Saturation Voltage	$V_{BE(SAT)}$	0.6	1.2 2.0	V	$I_C = 150\text{mA}, I_B = 15\text{mA}$ $I_C = 500\text{mA}, I_B = 50\text{mA}$	
<b>SMALL SIGNAL CHARACTERISTICS</b>						
Output Capacitance	$C_{obo}$	—	8	pF	$V_{CB} = 10\text{V}, f = 1.0\text{MHz}, I_E = 0$	
Input Capacitance	$C_{ibo}$	—	25	pF	$V_{EB} = 0.5\text{V}, f = 1.0\text{MHz}, I_C = 0$	
Current Gain-Bandwidth Product	$f_T$	300	—	MHz	$V_{CE} = 20\text{V}, I_C = 20\text{mA}, f = 100\text{MHz}$	
<b>SWITCHING CHARACTERISTICS</b>						
Delay Time	$t_d$	—	10	ns	$V_{CC} = 30\text{V}, I_C = 150\text{mA}, V_{BE(off)} = -0.5\text{V}, I_{B1} = 15\text{mA}$	
Rise Time	$t_r$	—	25	ns		
Storage Time	$t_s$	—	225	ns	$V_{CC} = 30\text{V}, I_C = 150\text{mA}, I_{B1} = I_{B2} = 15\text{mA}$	
Fall Time	$t_f$	—	60	ns		

Notes: 4. Pulse test: pulse width  $\leq 300\mu\text{s}$ , duty cycle  $\leq 2\%$ .

## Electrical Characteristics: 2907A Type (PNP) @T<sub>A</sub> = 25°C unless otherwise specified

Characteristic	Symbol	Min	Max	Unit	Test Condition
<b>OFF CHARACTERISTICS (Note 4)</b>					
Collector-Base Breakdown Voltage	V <sub>(BR)CBO</sub>	-60	—	V	I <sub>C</sub> = -10μA, I <sub>E</sub> = 0
Collector-Emitter Breakdown Voltage	V <sub>(BR)CEO</sub>	-60	—	V	I <sub>C</sub> = -10mA, I <sub>B</sub> = 0
Emitter-Base Breakdown Voltage	V <sub>(BR)EBO</sub>	-5.0	—	V	I <sub>E</sub> = -10μA, I <sub>C</sub> = 0
Collector Cutoff Current	I <sub>CBO</sub>	—	-10	nA μA	V <sub>CB</sub> = -50V, I <sub>E</sub> = 0 V <sub>CB</sub> = -50V, I <sub>E</sub> = 0, T <sub>A</sub> = 125°C
Collector Cutoff Current	I <sub>CEX</sub>	—	-50	nA	V <sub>CE</sub> = -30V, V <sub>EB(OFF)</sub> = -0.5V
Base Cutoff Current	I <sub>BL</sub>	—	-50	nA	V <sub>CE</sub> = -30V, V <sub>EB(OFF)</sub> = -0.5V
<b>ON CHARACTERISTICS (Note 4)</b>					
DC Current Gain	h <sub>FE</sub>	75 100 100 100 50	— — — 300 —	—	I <sub>C</sub> = -100μA, V <sub>CE</sub> = -10V I <sub>C</sub> = -1.0mA, V <sub>CE</sub> = -10V I <sub>C</sub> = -10mA, V <sub>CE</sub> = -10V I <sub>C</sub> = -150mA, V <sub>CE</sub> = -10V I <sub>C</sub> = -500mA, V <sub>CE</sub> = -10V
Collector-Emitter Saturation Voltage	V <sub>CE(SAT)</sub>	—	-0.4 -1.6	V	I <sub>C</sub> = -150mA, I <sub>B</sub> = -15mA I <sub>C</sub> = -500mA, I <sub>B</sub> = -50mA
Base-Emitter Saturation Voltage	V <sub>BE(SAT)</sub>	—	-1.3 -2.6	V	I <sub>C</sub> = 150mA, I <sub>B</sub> = 15mA I <sub>C</sub> = 500mA, I <sub>B</sub> = 50mA
<b>SMALL SIGNAL CHARACTERISTICS</b>					
Output Capacitance	C <sub>obo</sub>	—	8.0	pF	V <sub>CB</sub> = -10V, f = 1.0MHz, I <sub>E</sub> = 0
Input Capacitance	C <sub>ibo</sub>	—	30	pF	V <sub>EB</sub> = -2.0V, f = 1.0MHz, I <sub>C</sub> = 0
Current Gain-Bandwidth Product	f <sub>T</sub>	200	—	MHz	V <sub>CE</sub> = -20V, I <sub>C</sub> = -50mA, f = 100MHz
<b>SWITCHING CHARACTERISTICS</b>					
Turn-On Time	t <sub>on</sub>	—	45	ns	V <sub>CC</sub> = -30V, I <sub>C</sub> = -150mA, I <sub>B1</sub> = -15mA
Delay Time	t <sub>d</sub>	—	10	ns	
Rise Time	t <sub>r</sub>	—	40	ns	
Turn-Off Time	t <sub>off</sub>	—	100	ns	V <sub>CC</sub> = -6.0V, I <sub>C</sub> = -150mA, I <sub>B1</sub> = I <sub>B2</sub> = -15mA
Storage Time	t <sub>s</sub>	—	80	ns	
Fall Time	t <sub>f</sub>	—	30	ns	

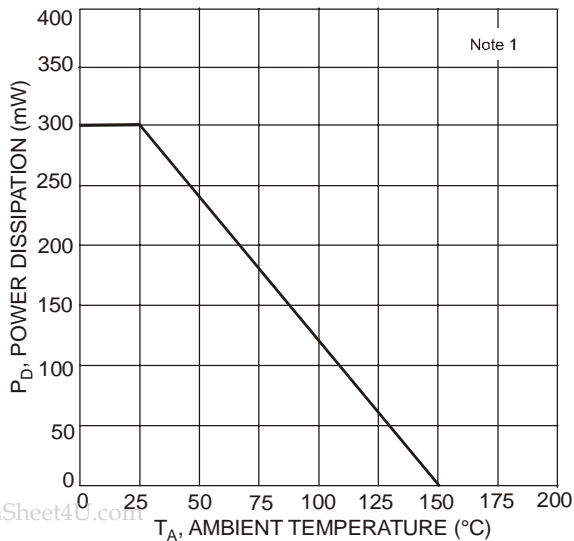

Fig. 1, Max Power Dissipation vs. Ambient Temperature

www.DataSheet4U.com

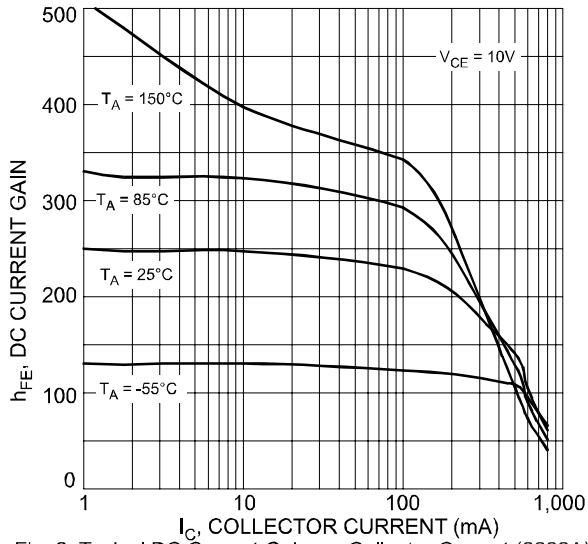

Fig. 2 Typical DC Current Gain vs. Collector Current (2222A)

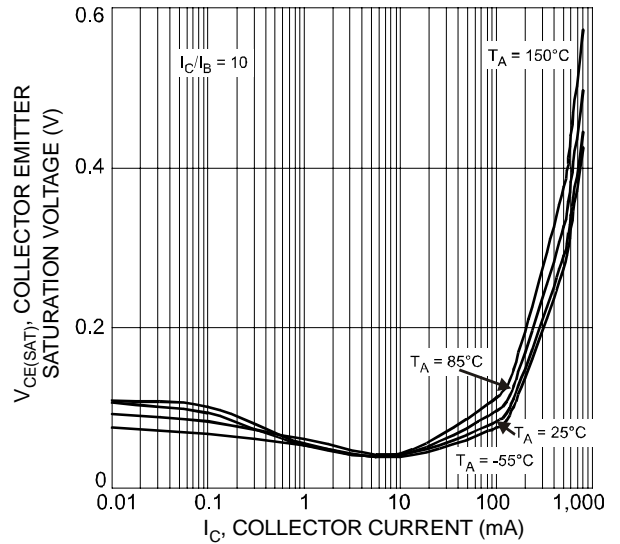

Fig. 3 Typical Collector Emitter Saturation Voltage vs. Collector Current (2222A)

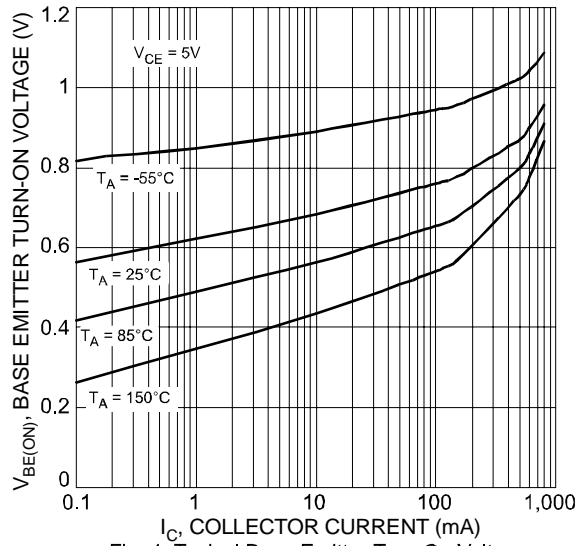

Fig. 4 Typical Base Emitter Turn-On Voltage vs. Collector Current (2222A)

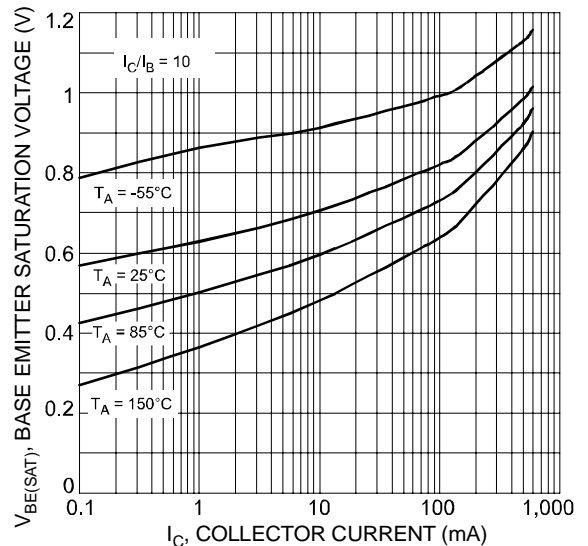

Fig. 5 Typical Base Emitter Saturation Voltage vs. Collector Current (2222A)

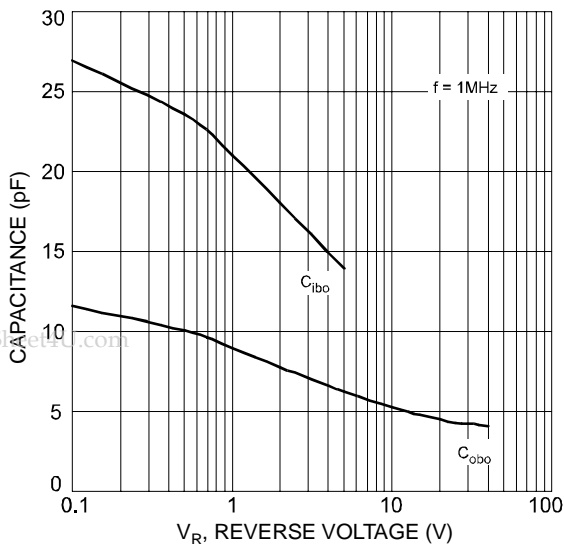

Fig. 6 Typical Capacitance Characteristics (2222A)

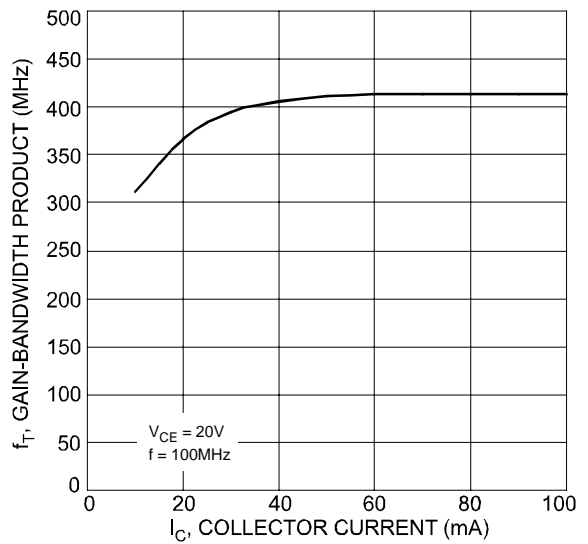

Fig. 7 Typical Gain-Bandwidth Product vs. Collector Current (2222A)

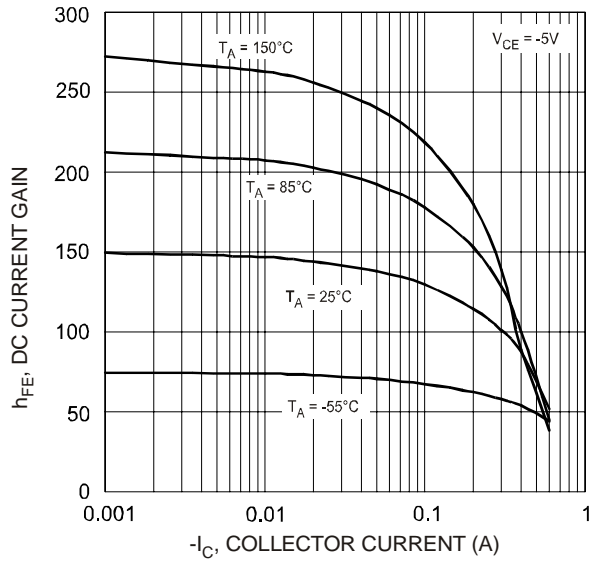

Fig. 8 Typical DC Current Gain vs. Collector Current (2907A)

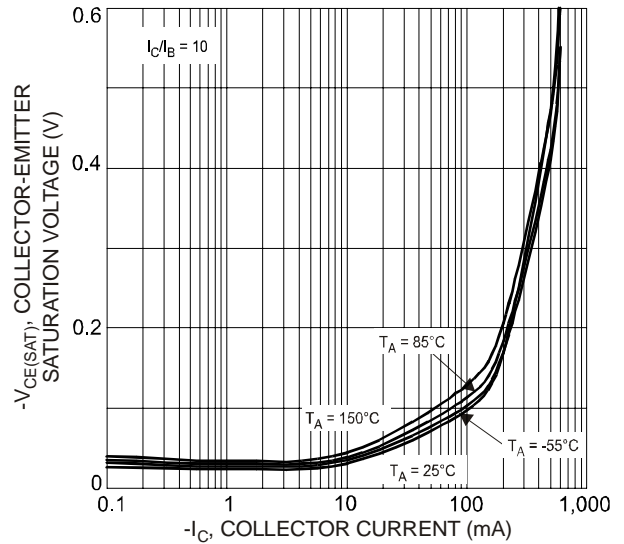

Fig. 9 Typical Collector-Emitter Saturation Voltage vs. Collector Current (2907A)

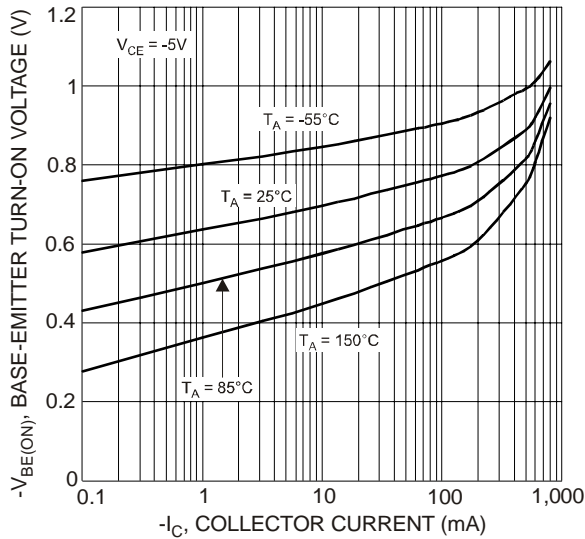

Fig. 10 Typical Base-Emitter Turn-On Voltage vs. Collector Current (2907A)

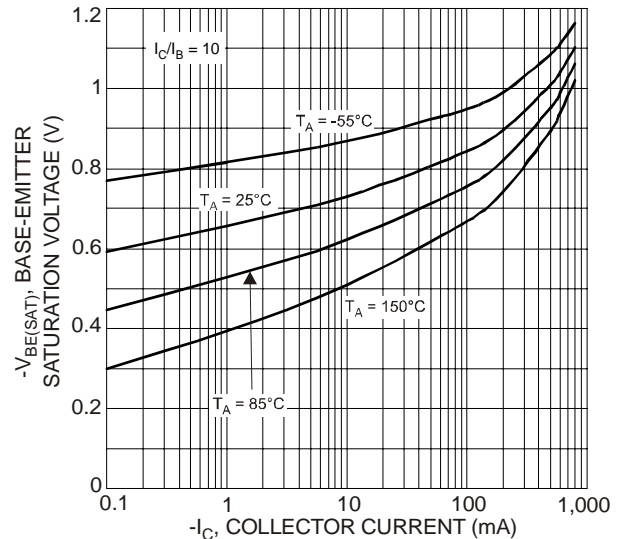

Fig. 11 Typical Base-Emitter Saturation Voltage vs. Collector Current (2907A)

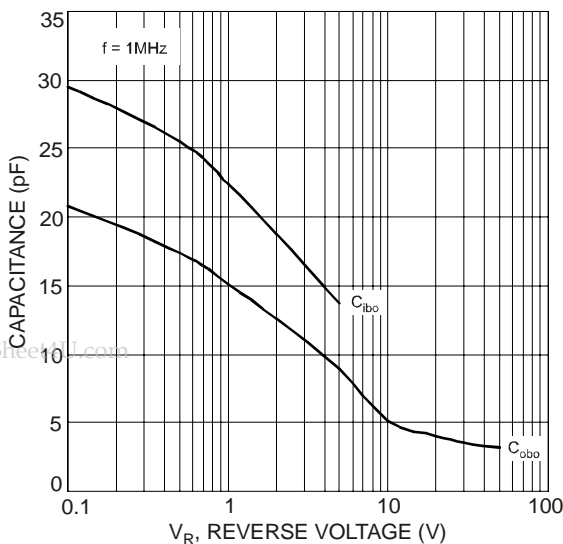

Fig. 12 Typical Capacitance Characteristics (2907A)

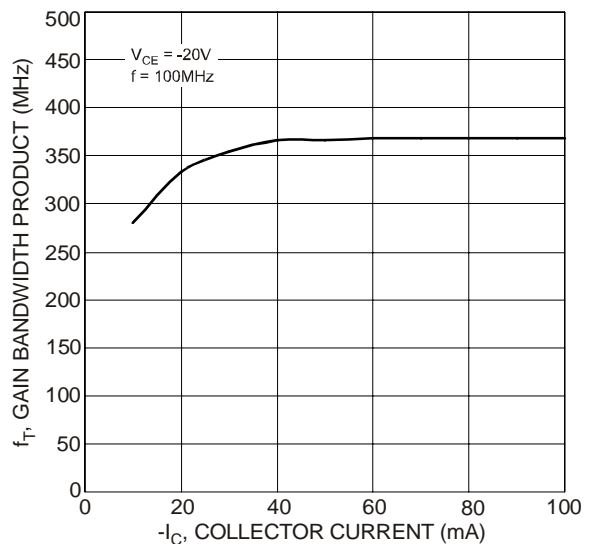

Fig. 13 Typical Gain-Bandwidth Product vs. Collector Current (2907A)

## Ordering Information (Note 5)

Device	Packaging	Shipping
DMB2227A-7	SOT-26	3000/Tape & Reel

Notes: 5. For packaging details, go to our website at <http://www.diodes.com/datasheets/ap02007.pdf>.

## Marking Information

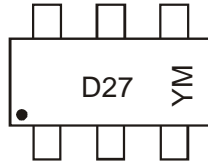

D27 = Product Type Marking Code  
 YM = Date Code Marking  
 Y = Year ex: U = 2007  
 M = Month ex: 9 = September

### Date Code Key

Year	2007	2008	2009	2010	2011	2012
Code	U	V	W	X	Y	Z

Month	Jan	Feb	Mar	Apr	May	Jun	Jul	Aug	Sep	Oct	Nov	Dec
Code	1	2	3	4	5	6	7	8	9	O	N	D

### IMPORTANT NOTICE

Diodes Incorporated and its subsidiaries reserve the right to make modifications, enhancements, improvements, corrections or other changes without further notice to any product herein. Diodes Incorporated does not assume any liability arising out of the application or use of any product described herein; neither does it convey any license under its patent rights, nor the rights of others. The user of products in such applications shall assume all risks of such use and will agree to hold Diodes Incorporated and all the companies whose products are represented on our website, harmless against all damages.

### LIFE SUPPORT

Diodes Incorporated products are not authorized for use as critical components in life support devices or systems without the expressed written approval of the President of Diodes Incorporated.

NEW PRODUCT