

www.DataSheet4U.com

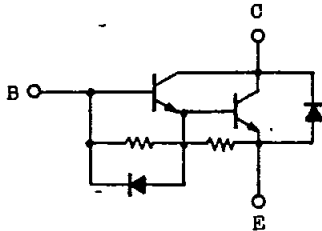

MG200H1AL2

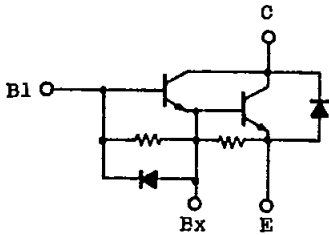

MG200H1FL1

Unit in mm

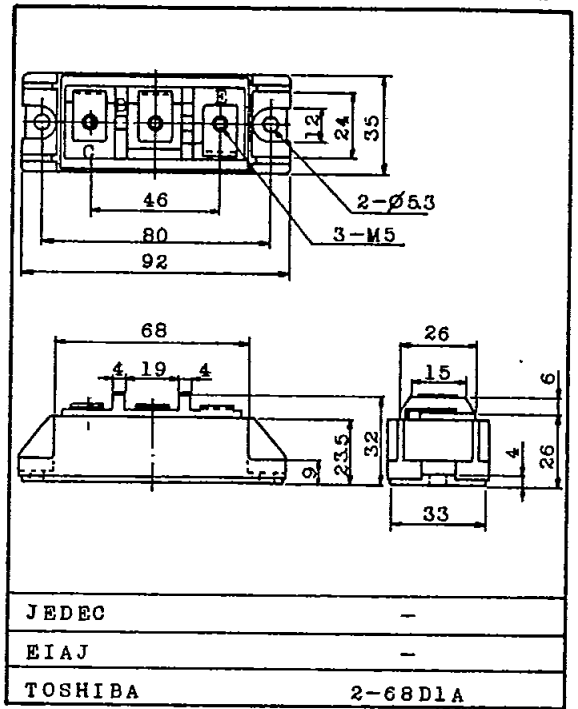

Weight : 210g

Unit in mm

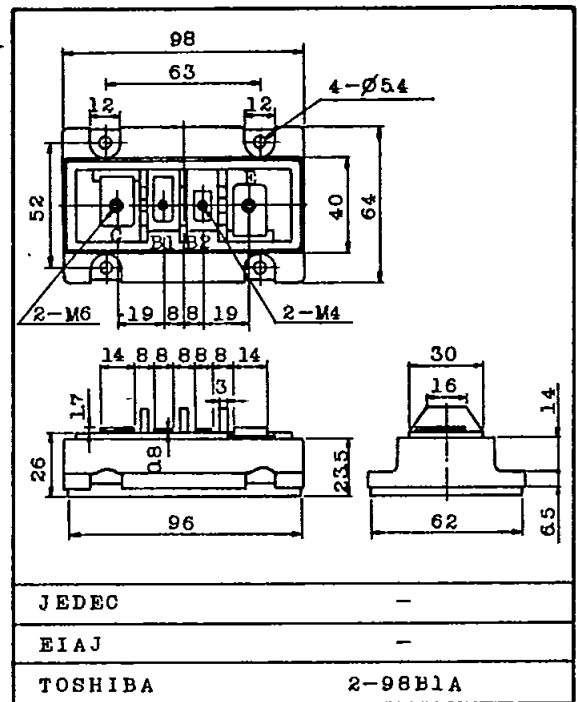

Weight : 420g

TOSHIBA CORPORATION



SEMICONDUCTOR

TECHNICAL DATA

MG200H1AL2
MG200H1FL1A

MAXIMUM RATINGS (Ta=25°C)

CHARACTERISTIC		SYMBOL	RATING	UNIT
Collector-Base Voltage		V _{CB10}	600	V
Collector-Emitter Voltage		V _{CEO}	600	V
Collector-Emitter Sustaining Voltage		V _{CEO(SUS)}	550	V
Emitter-Base Voltage		V _{EB10}	6	V
Collector Current	DC	I _C	200	A
	1ms	I _C	400	
	DC	-I _C	200	
Base Current		I _{B1}	8	A
Collector Power Dissipation (Tc=25°C)		P _C	800	W
Junction Temperature		T _j	150	°C
Storage Temperature Range		T _{stg}	-40 ~ 125	°C
Isolation Voltage		V _{Isol}	2500 (AC 1 Minute)	V
Screw Torque (Terminal M4/M6/Mounting)		-	20/30/30	kg·cm

ELECTRICAL CHARACTERISTICS (Ta=25°C)

CHARACTERISTIC		SYMBOL	TEST CONDITION	MIN.	TYP.	MAX.	UNIT
Collector Cut-off Current		I _{CB10}	V _{CB1} =600V, I _E =0	-	-	2.0	mA
Emitter Cut-off Current		I _{EB10}	V _{EB1} =6V, I _C =0	-	-	400	mA
Collector-Emitter Sustaining Voltage		V _{CEO(SUS)}	I _C =0.5A, L=40mH	550	-	-	V
DC Current Gain		h _{FE}	V _{CE} =5V, I _C =200A	80	-	-	
Collector-Emitter Saturation Voltage		V _{CE(sat)}	I _C =200A, I _{B1} =6A	-	-	2.0	V
Base-Emitter Saturation Voltage		V _{BE1(sat)}		-	-	2.7	V
Emitter-Collector Voltage		V _{ECO}	I _E =200A, I _{B1} =0	-	-	1.5	V
Reverse Recovery Time		t _{rr}	-I _C =200A, V _{EB1} =3V V _{CE} =300V	-	-	2.0	μs
Collector Output Capacitance		C _{ob1}	V _{CB1} =50V, I _E =0 f=1MHz	-	1670	-	pF
Switching Time	Turn-on Time	t _{on}		-	-	2.0	μs
	Storage Time	t _{stg}		-	-	12	
	Fall Time	t _f		I _{B1} =-I _{B2} =6A DUTY CYCLE=0.5%	-	-	
Thermal Resistance (Junction to Case)		R _{th(j-c)}	Transistor	-	-	0.156	°C/W
			Diode	-	-	0.65	

TOSHIBA CORPORATION

GT1A2A

- 286 -

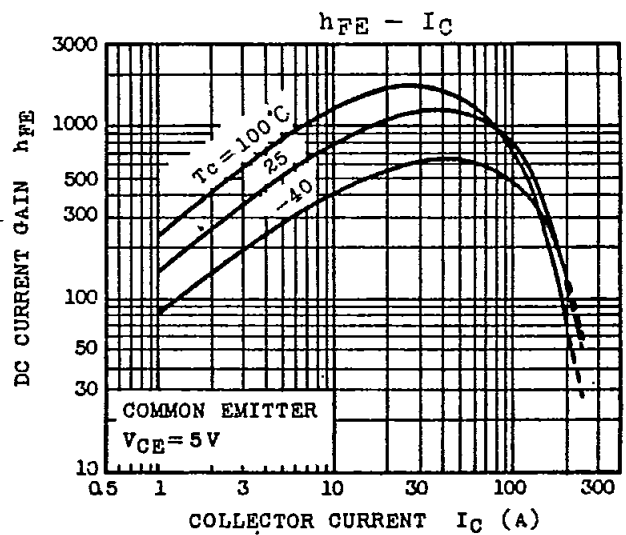
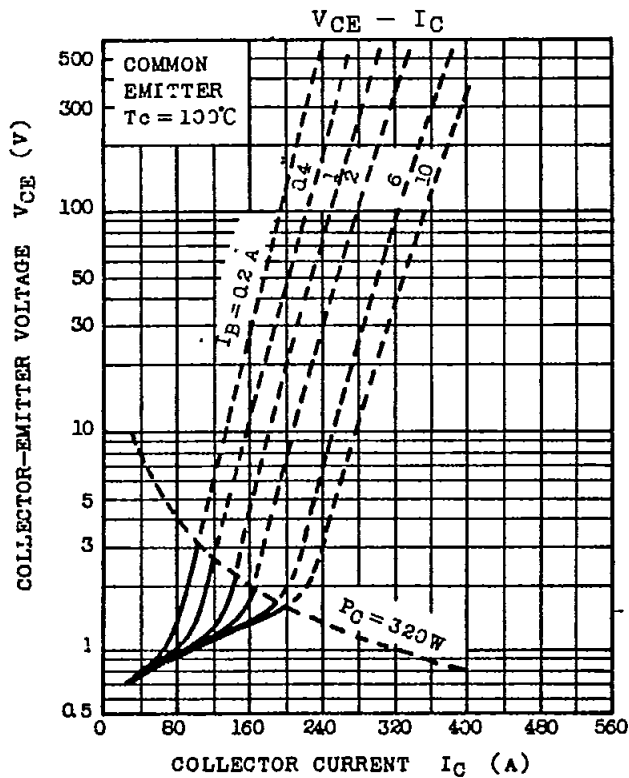
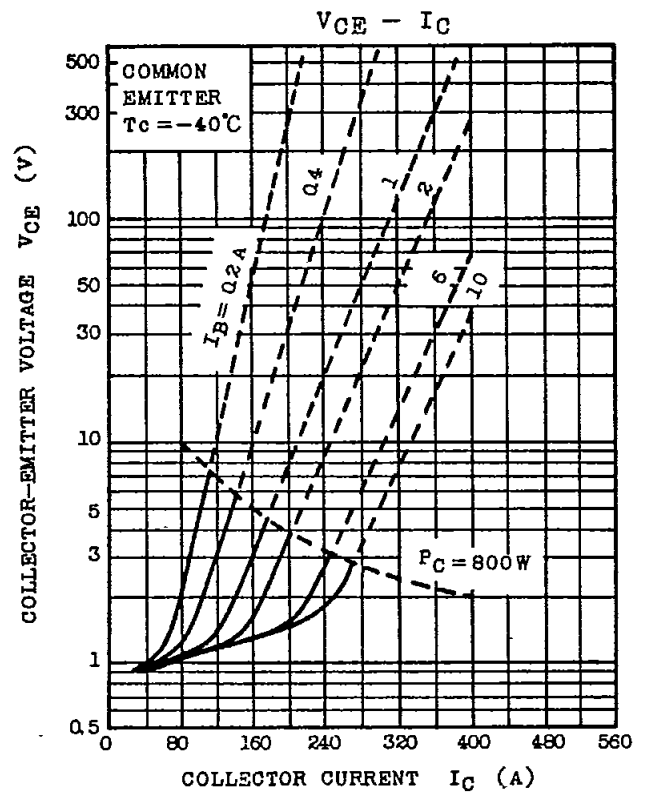
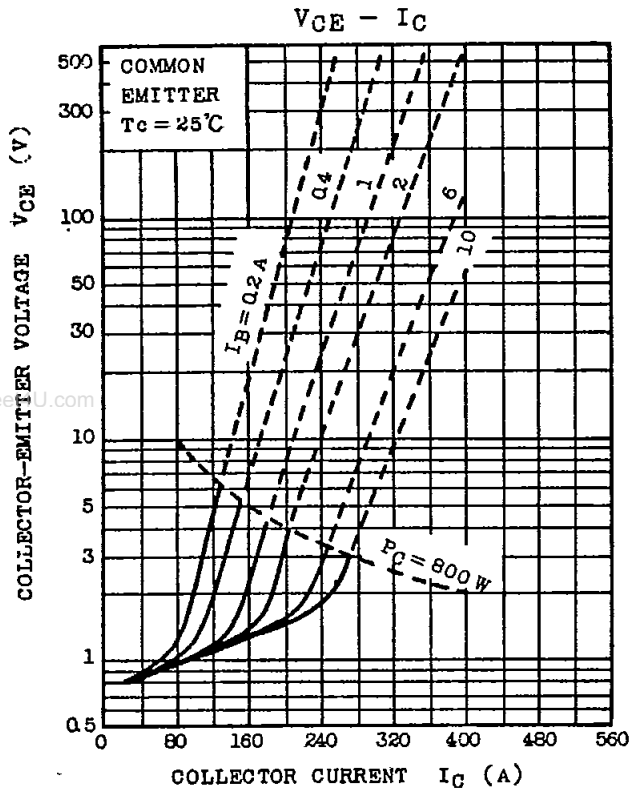

TOSHIBA CORPORATION

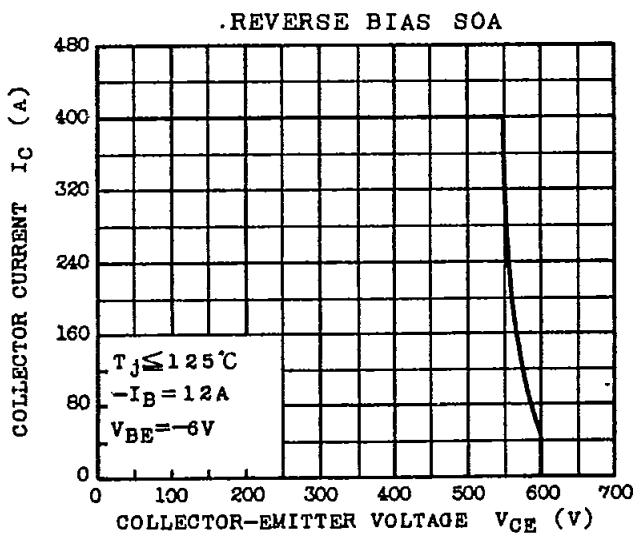
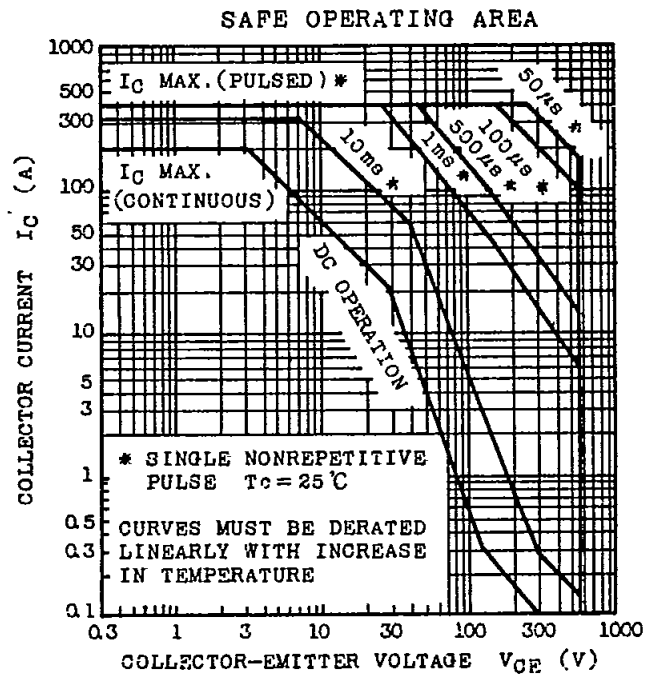
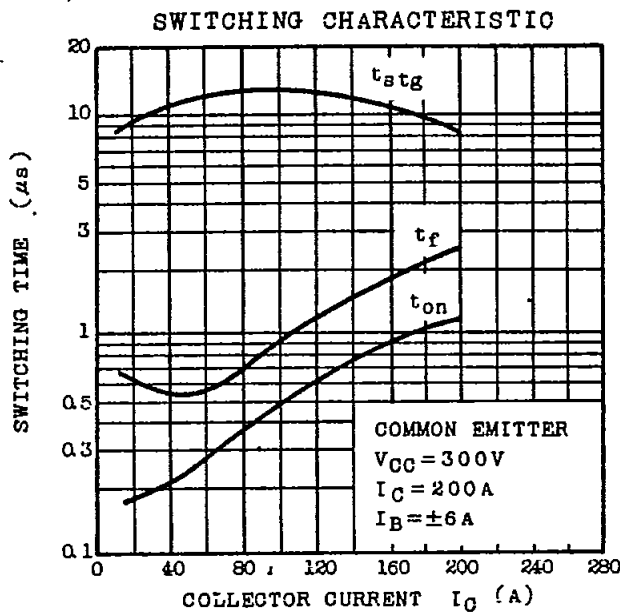
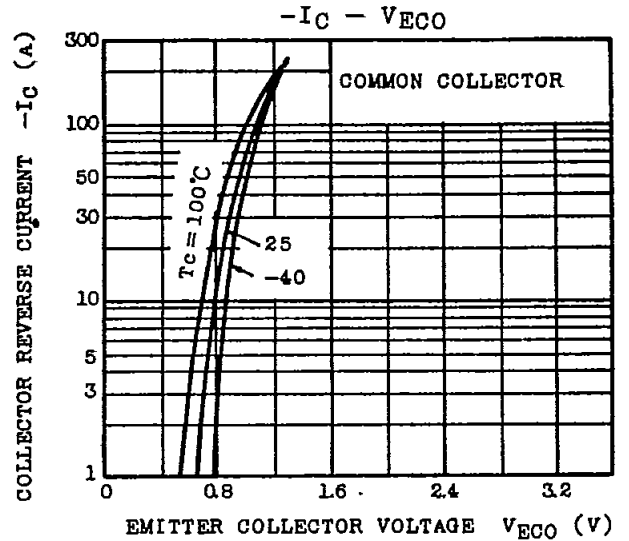
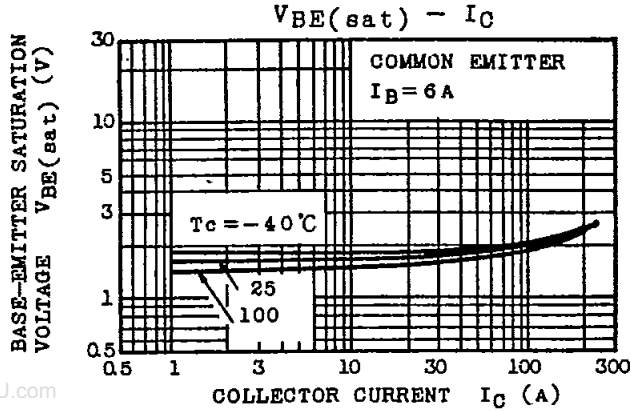

TOSHIBA CORPORATION



SEMICONDUCTOR

TECHNICAL DATA

MG200H1AL2
MG200H1FL1A

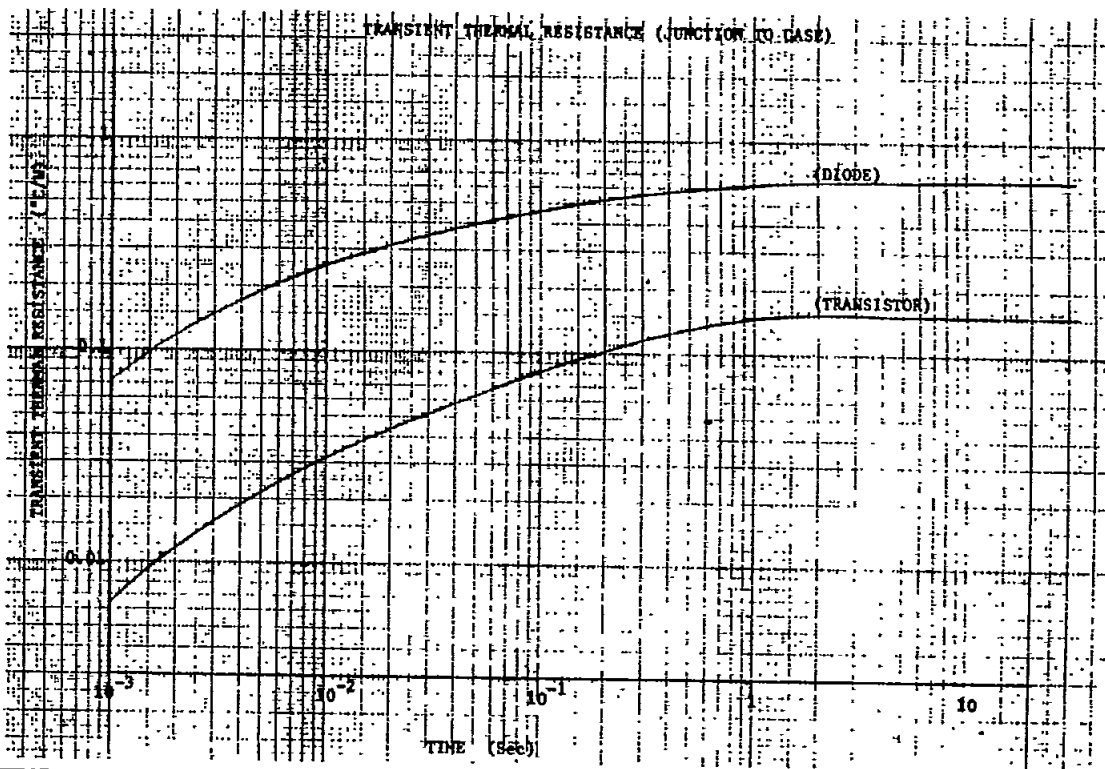
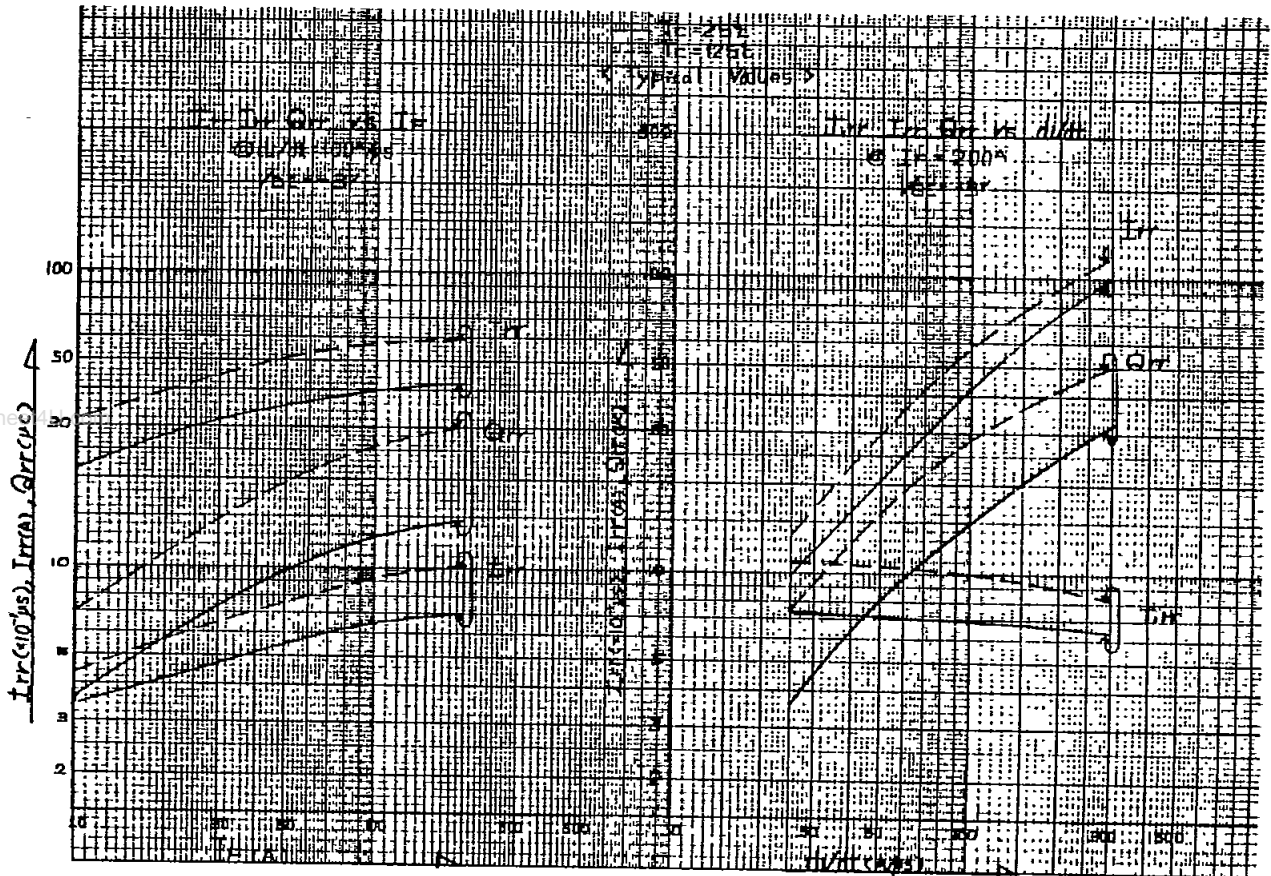

TOSHIBA CORPORATION

GT1A2A