

# NTMS4N01R2

## Power MOSFET

### 4.2 Amps, 20 Volts

#### N-Channel Enhancement-Mode Single SO-8 Package

##### Features

- High Density Power MOSFET with Ultra Low  $R_{DS(on)}$  Providing Higher Efficiency
- Miniature SO-8 Surface Mount Package Saving Board Space; Mounting Information for the SO-8 Package is Provided
- $I_{DSS}$  Specified at Elevated Temperature
- Drain-to-Source Avalanche Energy Specified
- Diode Exhibits High Speed, Soft Recovery
- Pb-Free Package is Available

##### Applications

- Power Management in Portable and Battery-Powered Products, i.e.: Computers, Printers, PCMCIA Cards, Cellular & Cordless Telephones

##### MAXIMUM RATINGS ( $T_J = 25^\circ\text{C}$ unless otherwise noted)

| Rating   | Symbol          | Value       | Unit               |
|--|-----------------|-------------|--------------------|
| Drain-to-Source Voltage  | $V_{DSS}$       | 20          | V                  |
| Drain-to-Gate Voltage ( $R_{GS} = 1.0 \text{ m}\Omega$ )   | $V_{DGR}$       | 20          | V                  |
| Gate-to-Source Voltage – Continuous  | $V_{GS}$        | $\pm 10$    | V                  |
| Thermal Resistance, Junction-to-Ambient (Note 1)   | $R_{\theta JA}$ | 50          | $^\circ\text{C/W}$ |
| Total Power Dissipation @ $T_A = 25^\circ\text{C}$   | $P_D$           | 2.5         | W                  |
| Continuous Drain Current @ $25^\circ\text{C}$  | $I_D$           | 5.9         | A                  |
| Continuous Drain Current @ $70^\circ\text{C}$  | $I_D$           | 4.7         | A                  |
| Pulsed Drain Current (Note 4)  | $I_{DM}$        | 25          | A                  |
| Thermal Resistance, Junction-to-Ambient (Note 2)   | $R_{\theta JA}$ | 100         | $^\circ\text{C/W}$ |
| Total Power Dissipation @ $T_A = 25^\circ\text{C}$   | $P_D$           | 1.25        | W                  |
| Continuous Drain Current @ $25^\circ\text{C}$  | $I_D$           | 4.2         | A                  |
| Continuous Drain Current @ $70^\circ\text{C}$  | $I_D$           | 3.3         | A                  |
| Pulsed Drain Current (Note 4)  | $I_{DM}$        | 20          | A                  |
| Thermal Resistance, Junction-to-Ambient (Note 3)   | $R_{\theta JA}$ | 162         | $^\circ\text{C/W}$ |
| Total Power Dissipation @ $T_A = 25^\circ\text{C}$   | $P_D$           | 0.77        | W                  |
| Continuous Drain Current @ $25^\circ\text{C}$  | $I_D$           | 3.3         | A                  |
| Continuous Drain Current @ $70^\circ\text{C}$  | $I_D$           | 2.6         | A                  |
| Pulsed Drain Current (Note 4)  | $I_{DM}$        | 15          | A                  |
| Operating and Storage Temperature Range  | $T_J, T_{stg}$  | -55 to +150 | $^\circ\text{C}$   |
| Single Pulse Drain-to-Source Avalanche Energy – Starting $T_J = 25^\circ\text{C}$ ( $V_{DD} = 20 \text{ Vdc}$ , $V_{GS} = 5.0 \text{ Vdc}$ , Peak $I_L = 7.5 \text{ Apk}$ , $L = 6 \text{ mH}$ , $R_G = 25 \Omega$ ) | $E_{AS}$        | 169         | mJ                 |
| Maximum Lead Temperature for Soldering Purposes, 1/8" from case for 10 seconds   | $T_L$           | 260         | $^\circ\text{C}$   |

Maximum ratings are those values beyond which device damage can occur. Maximum ratings applied to the device are individual stress limit values (not normal operating conditions) and are not valid simultaneously. If these limits are exceeded, device functional operation is not implied, damage may occur and reliability may be affected.

1. Mounted onto a 2" square FR-4 Board (1" sq. 2 oz Cu 0.06" thick single sided),  $t \leq 10$  seconds.
2. Mounted onto a 2" square FR-4 Board (1" sq. 2 oz Cu 0.06" thick single sided),  $t = \text{steady state}$ .
3. Minimum FR-4 or G-10 PCB,  $t = \text{Steady State}$ .
4. Pulse Test: Pulse Width = 300  $\mu\text{s}$ , Duty Cycle = 2%.

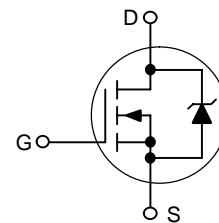


ON Semiconductor®

<http://onsemi.com>

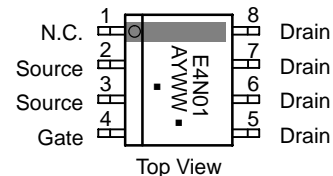
**4.2 AMPERES, 20 VOLTS**  
**0.045  $\Omega$  @  $V_{GS} = 4.5 \text{ V}$**

##### Single N-Channel



**SO-8**  
**CASE 751**  
**STYLE 13**

##### MARKING DIAGRAM AND PIN ASSIGNMENT



E4N01 = Device Code  
A = Assembly Location  
Y = Year  
WW = Work Week  
▪ = Pb-Free Package

(Note: Microdot may be in either location)

##### ORDERING INFORMATION

| Device      | Package        | Shipping†          |
|-------------|----------------|--------------------|
| NTMS4N01R2  | SO-8           | 2500 / Tape & Reel |
| NTMS4N01R2G | SO-8 (Pb-Free) | 2500 / Tape & Reel |

†For information on tape and reel specifications, including part orientation and tape sizes, please refer to our Tape and Reel Packaging Specification Brochure, BRD8011/D.

# NTMS4N01R2

## ELECTRICAL CHARACTERISTICS (T<sub>C</sub> = 25°C unless otherwise noted) (Note 5)

| Characteristic | Symbol | Min | Typ | Max | Unit |
|----------------|--------|-----|-----|-----|------|
|----------------|--------|-----|-----|-----|------|

### OFF CHARACTERISTICS

|  |                      |    |     |      |       |
|--|----------------------|----|-----|------|-------|
| Drain-to-Source Breakdown Voltage<br>(V <sub>GS</sub> = 0 Vdc, I <sub>D</sub> = 250 μAdc)<br>Temperature Coefficient (Positive)  | V <sub>(BR)DSS</sub> | 20 | –   | –    | Vdc   |
|  |                      | –  | 20  | –    | mV/°C |
| Zero Gate Voltage Drain Current<br>(V <sub>DS</sub> = 12 Vdc, V <sub>GS</sub> = 0 Vdc, T <sub>J</sub> = 25°C)<br>(V <sub>DS</sub> = 12 Vdc, V <sub>GS</sub> = 0 Vdc, T <sub>J</sub> = 125°C)<br>(V <sub>DS</sub> = 20 Vdc, V <sub>GS</sub> = 0 Vdc, T <sub>J</sub> = 25°C) | I <sub>DSS</sub>     | –  | –   | 1.0  | μAdc  |
|  |                      | –  | –   | 10   |       |
|  |                      | –  | 0.2 | –    |       |
| Gate-Body Leakage Current<br>(V <sub>GS</sub> = +10 Vdc, V <sub>DS</sub> = 0 Vdc)  | I <sub>GSS</sub>     | –  | –   | 100  | nAdc  |
| Gate-Body Leakage Current<br>(V <sub>GS</sub> = -10 Vdc, V <sub>DS</sub> = 0 Vdc)  | I <sub>GSS</sub>     | –  | –   | -100 | nAdc  |

### ON CHARACTERISTICS

|   |                     |     |       |      |       |
|---|---------------------|-----|-------|------|-------|
| Gate Threshold Voltage<br>(V <sub>DS</sub> = V <sub>GS</sub> , I <sub>D</sub> = 250 μAdc)<br>Temperature Coefficient (Negative)   | V <sub>GS(th)</sub> | 0.6 | 0.95  | 1.2  | Vdc   |
|   |                     | –   | -3.0  | –    | mV/°C |
| Static Drain-to-Source On-State Resistance<br>(V <sub>GS</sub> = 4.5 Vdc, I <sub>D</sub> = 4.2 Adc)<br>(V <sub>GS</sub> = 2.7 Vdc, I <sub>D</sub> = 2.1 Adc)<br>(V <sub>GS</sub> = 2.5 Vdc, I <sub>D</sub> = 2.0 Adc) | R <sub>DS(on)</sub> | –   | 0.030 | 0.04 | Ω     |
|   |                     | –   | 0.035 | 0.05 |       |
|   |                     | –   | 0.037 | –    |       |
| Forward Transconductance<br>(V <sub>DS</sub> = 2.5 Vdc, I <sub>D</sub> = 2.0 Adc)   | g <sub>FS</sub>     | –   | 10    | –    | Mhos  |

### DYNAMIC CHARACTERISTICS

|                              |   |                  |   |     |      |    |
|------------------------------|---|------------------|---|-----|------|----|
| Input Capacitance            | (V <sub>DS</sub> = 10 Vdc, V <sub>GS</sub> = 0 Vdc,<br>f = 1.0 MHz) | C <sub>ISS</sub> | – | 870 | 1200 | pF |
| Output Capacitance           |   | C <sub>OSS</sub> | – | 260 | 400  |    |
| Reverse Transfer Capacitance |   | C <sub>RSS</sub> | – | 60  | 100  |    |

### SWITCHING CHARACTERISTICS (Notes 6 & 7)

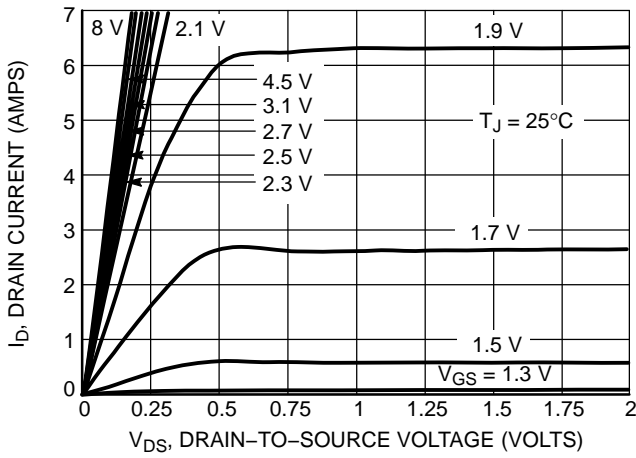
|                     |   |                     |   |     |    |    |
|---------------------|---|---------------------|---|-----|----|----|
| Turn-On Delay Time  | (V <sub>DD</sub> = 12 Vdc, I <sub>D</sub> = 4.2 Adc,<br>V <sub>GS</sub> = 4.5 Vdc,<br>R <sub>G</sub> = 2.3 Ω) | t <sub>d(on)</sub>  | – | 13  | 25 | ns |
| Rise Time           |   | t <sub>r</sub>      | – | 35  | 65 |    |
| Turn-Off Delay Time |   | t <sub>d(off)</sub> | – | 45  | 75 |    |
| Fall Time           |   | t <sub>f</sub>      | – | 50  | 90 |    |
| Total Gate Charge   | (V <sub>DS</sub> = 12 Vdc,<br>V <sub>GS</sub> = 4.5 Vdc,<br>I <sub>D</sub> = 4.2 Adc)                         | Q <sub>tot</sub>    | – | 11  | 16 | nC |
| Gate-Source Charge  |   | Q <sub>gs</sub>     | – | 2.0 | –  |    |
| Gate-Drain Charge   |   | Q <sub>gd</sub>     | – | 3.0 | –  |    |

### BODY-DRAIN DIODE RATINGS (Note 6)

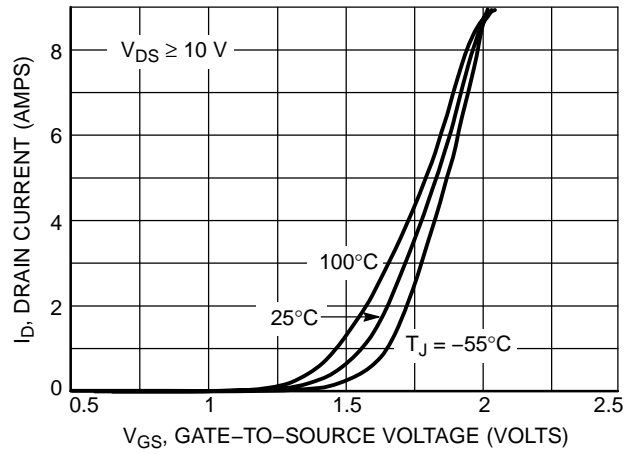
|                                |  |                 |   |      |     |     |
|--------------------------------|--|-----------------|---|------|-----|-----|
| Diode Forward On-Voltage       | (I <sub>S</sub> = 4.2 Adc, V <sub>GS</sub> = 0 Vdc)<br>(I <sub>S</sub> = 4.2 Adc, V <sub>GS</sub> = 0 Vdc, T <sub>J</sub> = 125°C) | V <sub>SD</sub> | – | 0.85 | 1.1 | Vdc |
|                                |  |                 | – | 0.70 | –   |     |
| Reverse Recovery Time          | (I <sub>S</sub> = 4.2 Adc, V <sub>GS</sub> = 0 Vdc,<br>di <sub>S</sub> /dt = 100 A/μs)   | t <sub>rr</sub> | – | 20   | –   | ns  |
|                                |  | t <sub>a</sub>  | – | 12   | –   |     |
|                                |  | t <sub>b</sub>  | – | 8.0  | –   |     |
| Reverse Recovery Stored Charge |  | Q <sub>RR</sub> | – | 0.01 | –   | μC  |

5. Handling precautions to protect against electrostatic discharge is mandatory.
6. Indicates Pulse Test: Pulse Width = 300 μs max, Duty Cycle = 2%.
7. Switching characteristics are independent of operating junction temperature.

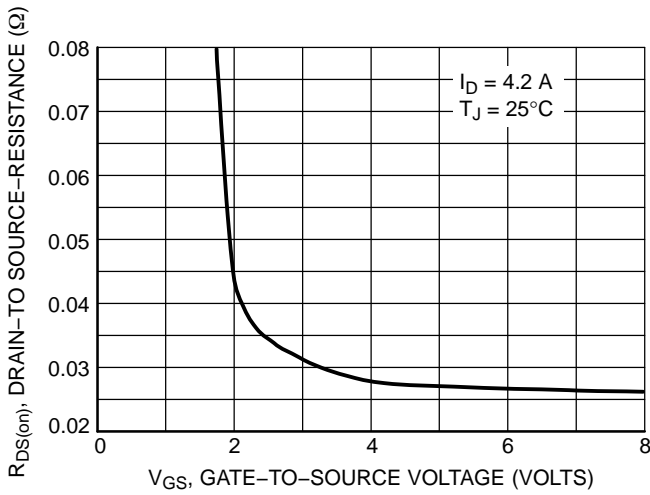
# NTMS4N01R2



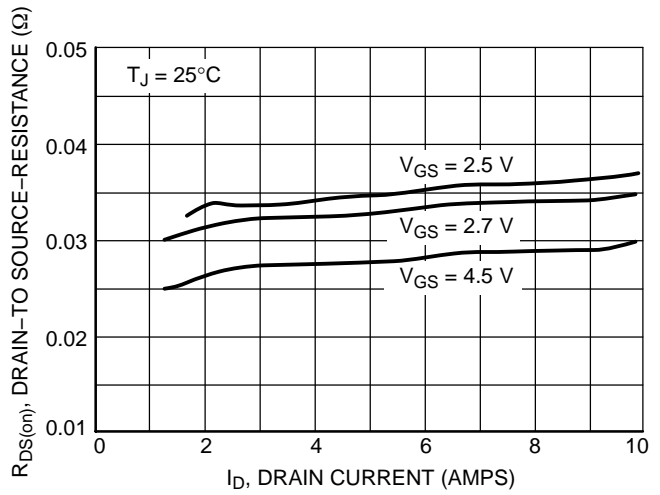
**Figure 1. On-Region Characteristics**



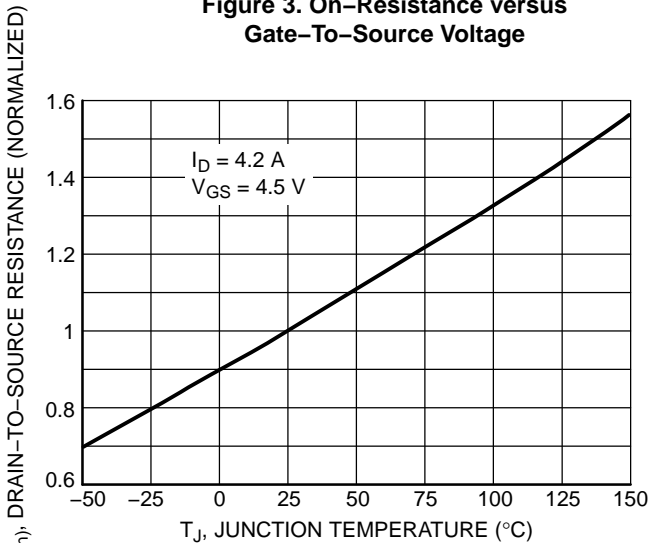
**Figure 2. Transfer Characteristics**



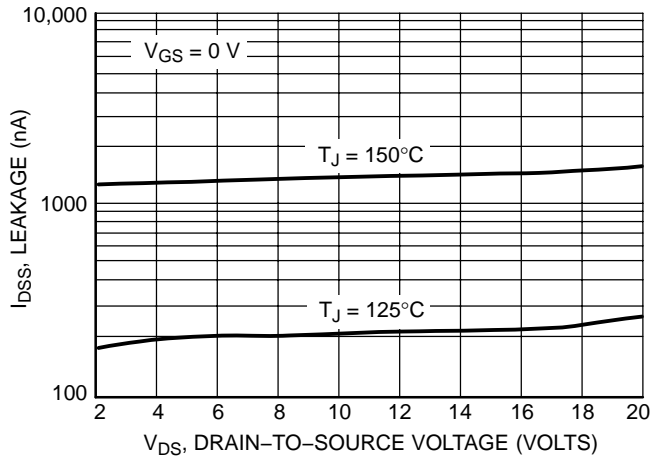
**Figure 3. On-Resistance versus Gate-to-Source Voltage**



**Figure 4. On-Resistance versus Drain Current and Gate Voltage**

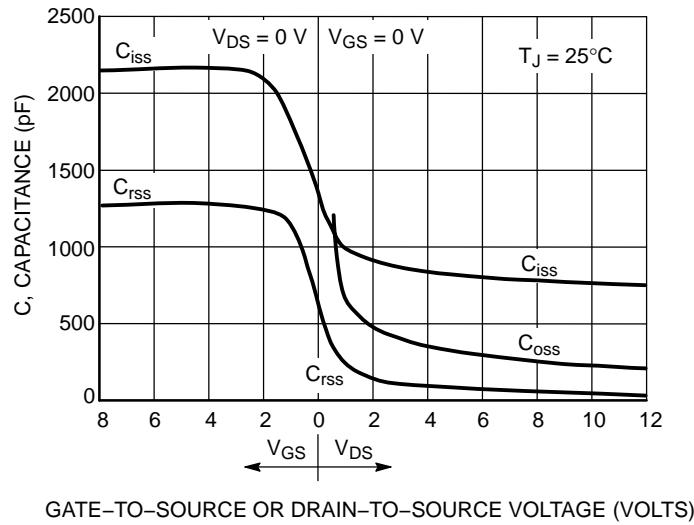


**Figure 5. On-Resistance Variation with Temperature**

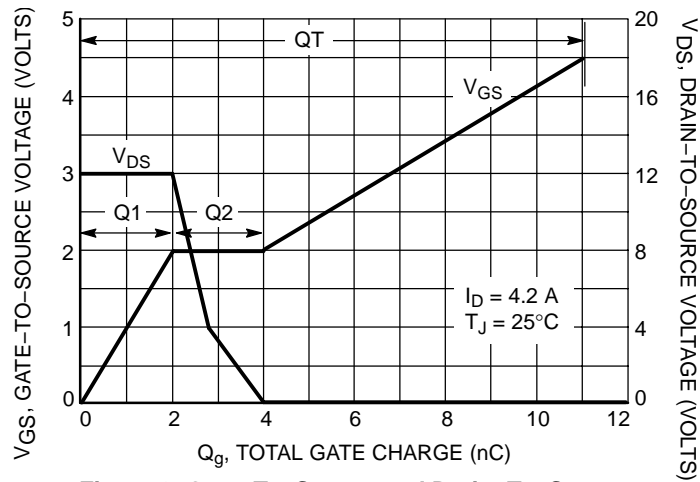


**Figure 6. Drain-to-Source Leakage Current versus Voltage**

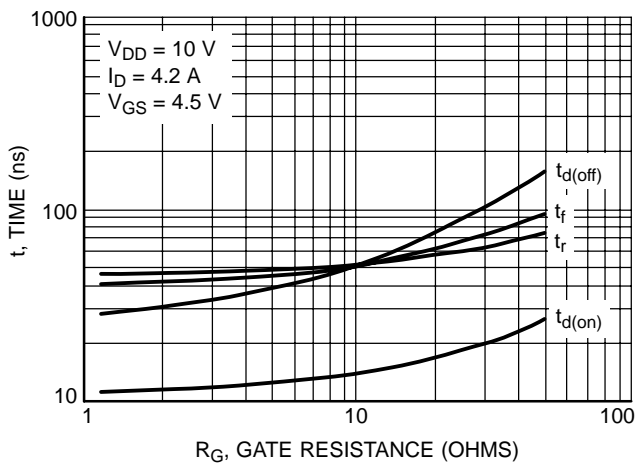
# NTMS4N01R2



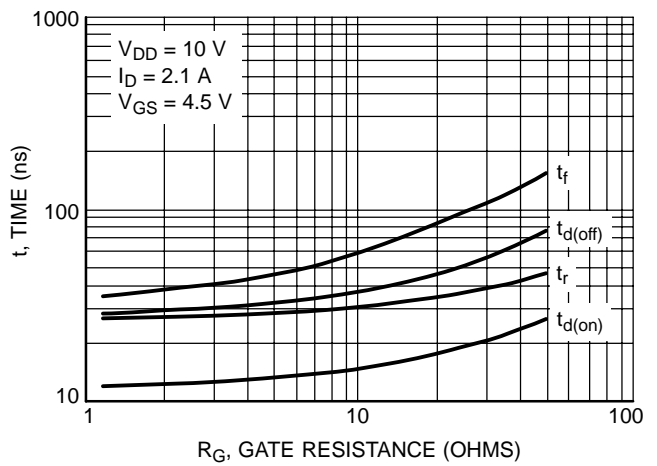
**Figure 7. Capacitance Variation**



**Figure 8. Gate-To-Source and Drain-To-Source Voltage versus Total Charge**



**Figure 9. Resistive Switching Time Variation versus Gate Resistance**



**Figure 10. Resistive Switching Time Variation versus Gate Resistance**

# NTMS4N01R2

## DRAIN-TO-SOURCE DIODE CHARACTERISTICS

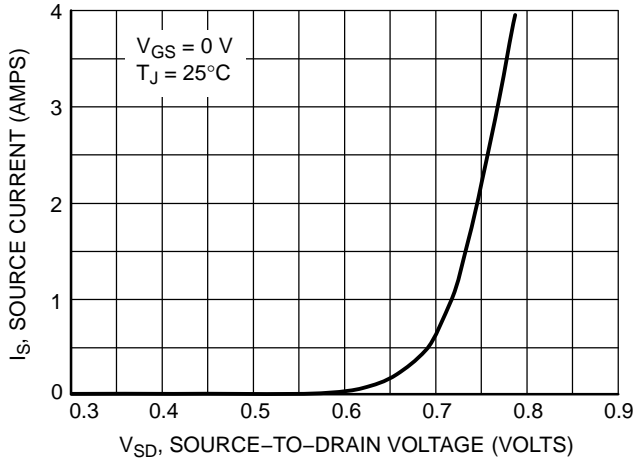


Figure 11. Diode Forward Voltage versus Current

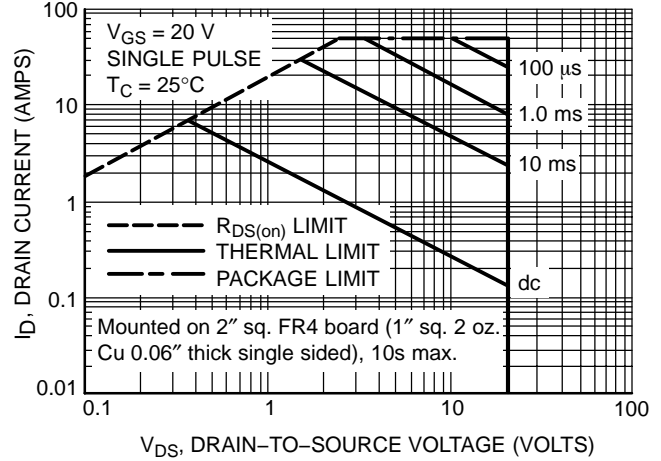


Figure 12. Maximum Rated Forward Biased Safe Operating Area

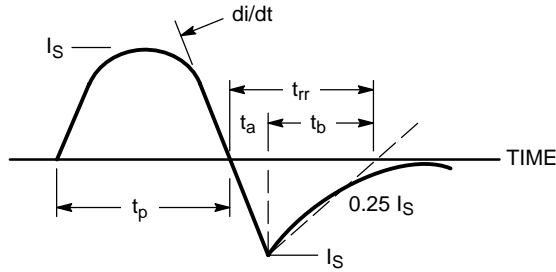


Figure 13. Diode Reverse Recovery Waveform

## TYPICAL ELECTRICAL CHARACTERISTICS

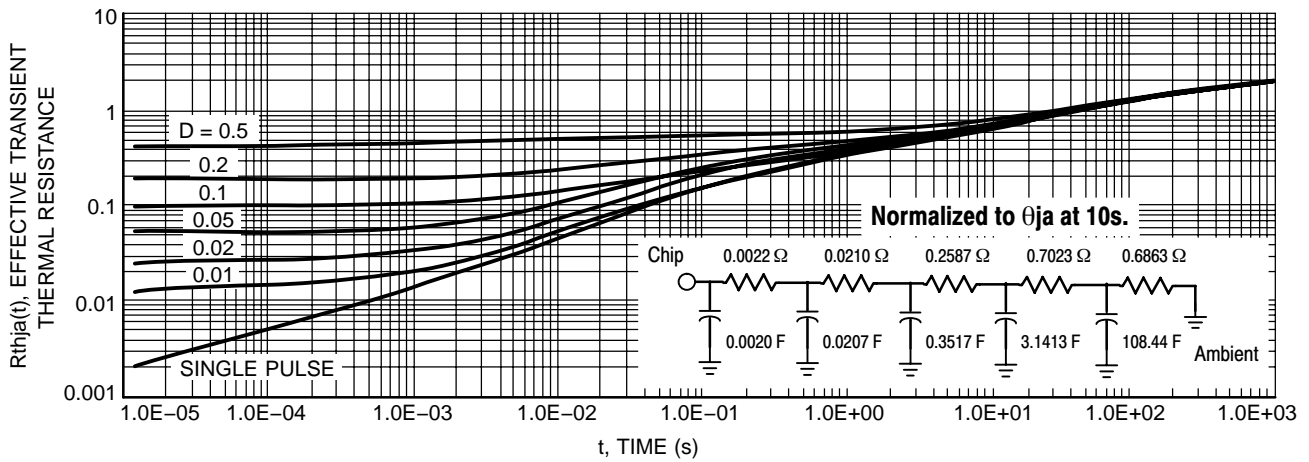
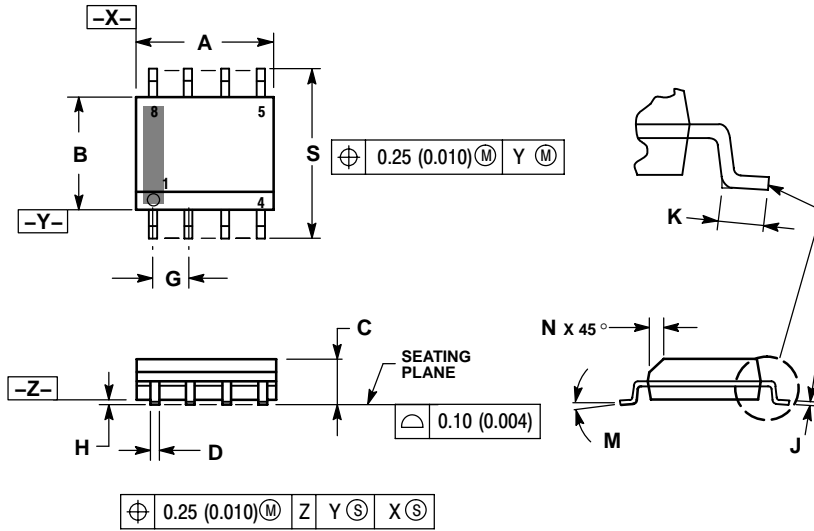


Figure 14. Thermal Response

# NTMS4N01R2

## PACKAGE DIMENSIONS

SOIC-8 NB  
CASE 751-07  
ISSUE AG



**NOTES:**

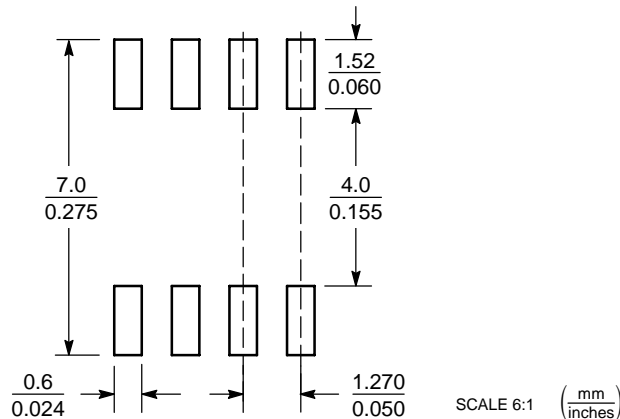
1. DIMENSIONING AND TOLERANCING PER ANSI Y14.5M, 1982.
2. CONTROLLING DIMENSION: MILLIMETER.
3. DIMENSION A AND B DO NOT INCLUDE MOLD PROTRUSION.
4. MAXIMUM MOLD PROTRUSION 0.15 (0.006) PER SIDE.
5. DIMENSION D DOES NOT INCLUDE DAMBAR PROTRUSION. ALLOWABLE DAMBAR PROTRUSION SHALL BE 0.127 (0.005) TOTAL IN EXCESS OF THE D DIMENSION AT MAXIMUM MATERIAL CONDITION.
6. 751-01 THRU 751-06 ARE OBSOLETE. NEW STANDARD IS 751-07.

| DIM | MILLIMETERS |      | INCHES    |       |
|-----|-------------|------|-----------|-------|
|     | MIN         | MAX  | MIN       | MAX   |
| A   | 4.80        | 5.00 | 0.189     | 0.197 |
| B   | 3.80        | 4.00 | 0.150     | 0.157 |
| C   | 1.35        | 1.75 | 0.053     | 0.069 |
| D   | 0.33        | 0.51 | 0.013     | 0.020 |
| G   | 1.27 BSC    |      | 0.050 BSC |       |
| H   | 0.10        | 0.25 | 0.004     | 0.010 |
| J   | 0.19        | 0.25 | 0.007     | 0.010 |
| K   | 0.40        | 1.27 | 0.016     | 0.050 |
| M   | 0°          | 8°   | 0°        | 8°    |
| N   | 0.25        | 0.50 | 0.010     | 0.020 |
| S   | 5.80        | 6.20 | 0.228     | 0.244 |

**STYLE 13:**

- PIN 1: N.C.  
 2. SOURCE  
 3. SOURCE  
 4. GATE  
 5. DRAIN  
 6. DRAIN  
 7. DRAIN  
 8. DRAIN

**SOLDERING FOOTPRINT\***



\*For additional information on our Pb-Free strategy and soldering details, please download the ON Semiconductor Soldering and Mounting Techniques Reference Manual, SOLDERRM/D.

ON Semiconductor and are registered trademarks of Semiconductor Components Industries, LLC (SCILLC). SCILLC reserves the right to make changes without further notice to any products herein. SCILLC makes no warranty, representation or guarantee regarding the suitability of its products for any particular purpose, nor does SCILLC assume any liability arising out of the application or use of any product or circuit, and specifically disclaims any and all liability, including without limitation special, consequential or incidental damages. "Typical" parameters which may be provided in SCILLC data sheets and/or specifications can and do vary in different applications and actual performance may vary over time. All operating parameters, including "Typicals" must be validated for each customer application by customer's technical experts. SCILLC does not convey any license under its patent rights nor the rights of others. SCILLC products are not designed, intended, or authorized for use as components in systems intended for surgical implant into the body, or other applications intended to support or sustain life, or for any other application in which the failure of the SCILLC product could create a situation where personal injury or death may occur. Should Buyer purchase or use SCILLC products for any such unintended or unauthorized application, Buyer shall indemnify and hold SCILLC and its officers, employees, subsidiaries, affiliates, and distributors harmless against all claims, costs, damages, and expenses, and reasonable attorney fees arising out of, directly or indirectly, any claim of personal injury or death associated with such unintended or unauthorized use, even if such claim alleges that SCILLC was negligent regarding the design or manufacture of the part. SCILLC is an Equal Opportunity/Affirmative Action Employer. This literature is subject to all applicable copyright laws and is not for resale in any manner.

**PUBLICATION ORDERING INFORMATION**

**LITERATURE FULFILLMENT:**  
 Literature Distribution Center for ON Semiconductor  
 P.O. Box 61312, Phoenix, Arizona 85082-1312 USA  
**Phone:** 480-829-7710 or 800-344-3860 Toll Free USA/Canada  
**Fax:** 480-829-7709 or 800-344-3867 Toll Free USA/Canada  
**Email:** orderlit@onsemi.com

**N. American Technical Support:** 800-282-9855 Toll Free USA/Canada  
**Japan:** ON Semiconductor, Japan Customer Focus Center  
 2-9-1 Kamimeguro, Meguro-ku, Tokyo, Japan 153-0051  
**Phone:** 81-3-5773-3850

**ON Semiconductor Website:** <http://onsemi.com>  
**Order Literature:** <http://www.onsemi.com/litorder>

For additional information, please contact your local Sales Representative.