

**NPN SWITCHING DARLINGTONS**

**DESCRIPTION**

Monolithic Darlingtons with integrated speed-up and damper diode, suited for TV applications.

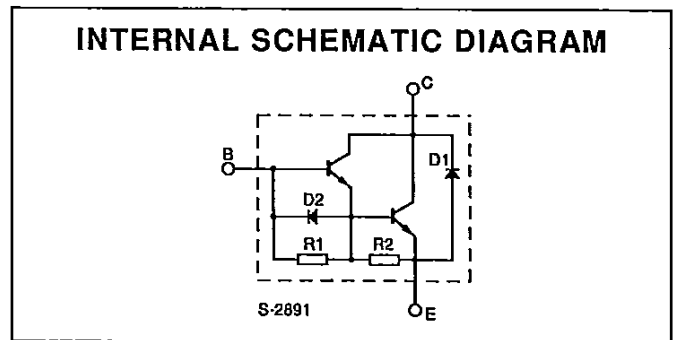
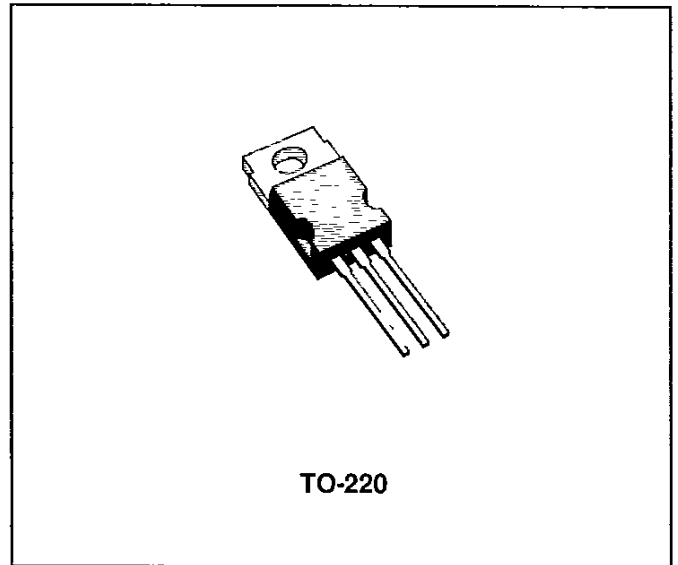

**ABSOLUTE MAXIMUM RATINGS**

Symbol	Parameter	Value		Unit
		BU184	BU189	
V <sub>CBO</sub>	Collector-base Voltage (I <sub>E</sub> = 0)	400	330	V
V <sub>CEX</sub>	Collector-emitter Voltage	400	330	V
V <sub>CEO</sub>	Collector-emitter Voltage (I <sub>B</sub> = 0)	200	150	V
V <sub>EBO</sub>	Emitter-base Voltage (I <sub>C</sub> = 0)	8		V
I <sub>C</sub>	Collector Current	8		A
I <sub>CM</sub>	Collector Peak Current (t <sub>p</sub> < 10ms)	15		A
I <sub>B</sub>	Base Current	2		A
I <sub>BM</sub>	Base Peak Current (t <sub>p</sub> < 10ms)	4		A
P <sub>tot</sub>	Total Dissipation at T <sub>c</sub> < 25°C	60		W
T <sub>stg</sub>	Storage Temperature	- 65 to + 150		°C
T <sub>j</sub>	Max. Operating Junction Temperature	150		°C

## THERMAL DATA

$R_{th\ j-case}$	Thermal Resistance Junction-case	Max	2.08	<small>www.DataSheet4U.com</small>	$^{\circ}C/W$
------------------	----------------------------------	-----	------	------------------------------------	---------------

## ELECTRICAL CHARACTERISTICS ( $T_{case} = 25^{\circ}C$ unless otherwise specified)

Symbol	Parameter	Test Conditions	Min.	Typ.	Max.	Unit
$I_{CEX}$	Collector Cutoff Current	$V_{CE} = V_{CEX}$ $V_{BE} = -6V$			100	$\mu A$
$I_{EBO}$	Emitter Cutoff Current ( $I_C = 0$ )	$V_{EB} = -8V$			10	mA
$V_{CE(sus)^*}$	Collector Emitter Sustaining Voltage	$I_C = 3A$ $L = 15mH$ for <b>BU184</b> for <b>BU189</b>	200			V V
$V_{CE(sat)^*}$	Collector-emitter Saturation Voltage	$I_C = 5A$ $I_B = 50mA$			1.5	V
$V_{BE(sat)^*}$	Base-emitter Saturation Voltage	$I_C = 5A$ $I_B = 50mA$			2.2	V
$V_F^*$	Diode Forward Voltage	$I_F = 4A$		1.8	2.3	V
$t_s$ $t_f$	RESISTIVE LOAD Storage Time Fall Time	See Test Circuit		0.44 0.3	0.5	$\mu s$ $\mu s$

\* Pulse test  $t_p < 300 \mu s$   $\delta < 2\%$ .

## TEST CIRCUIT

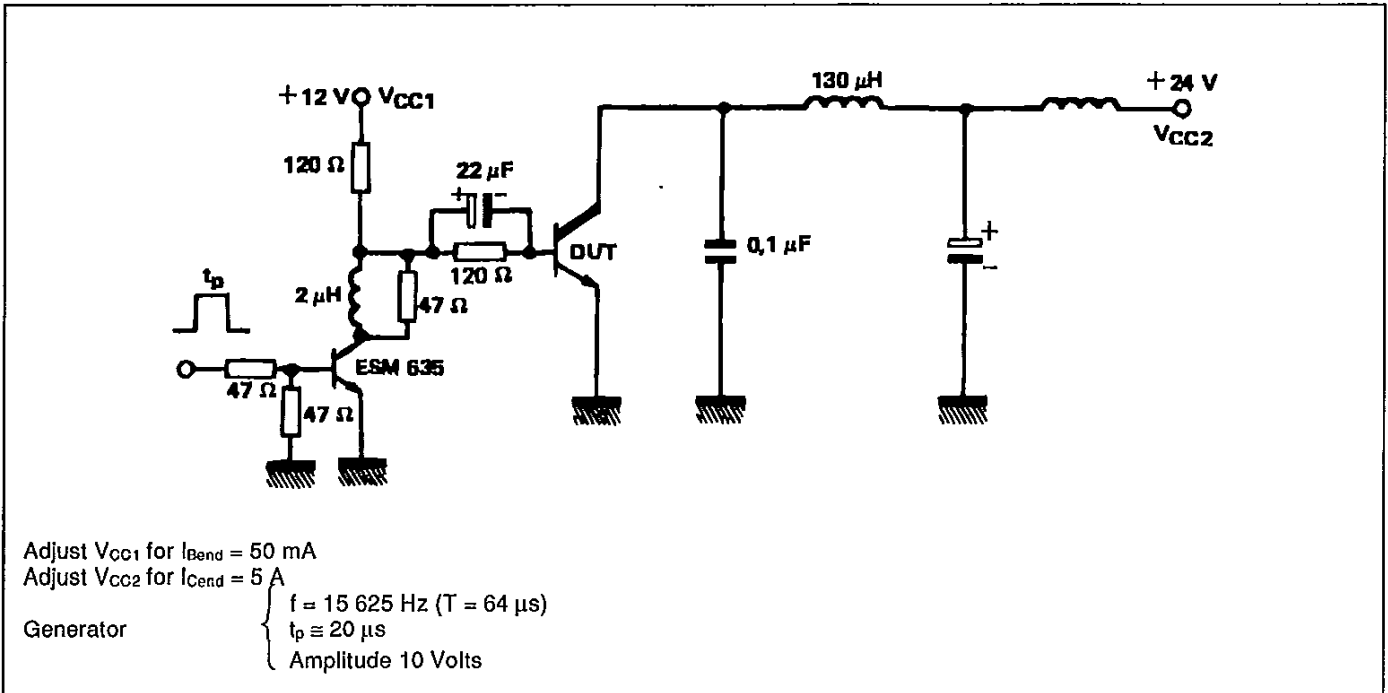

### DC and Pulse Area.

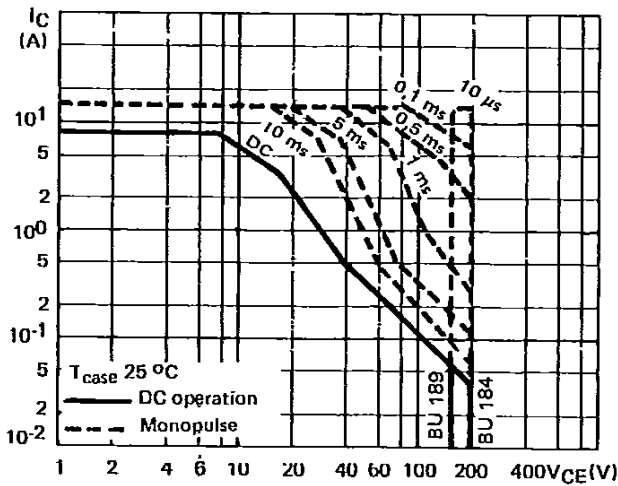

### Collector-emitter Voltage vs Base-emitter Resistance.

www.DataSheet4U.com

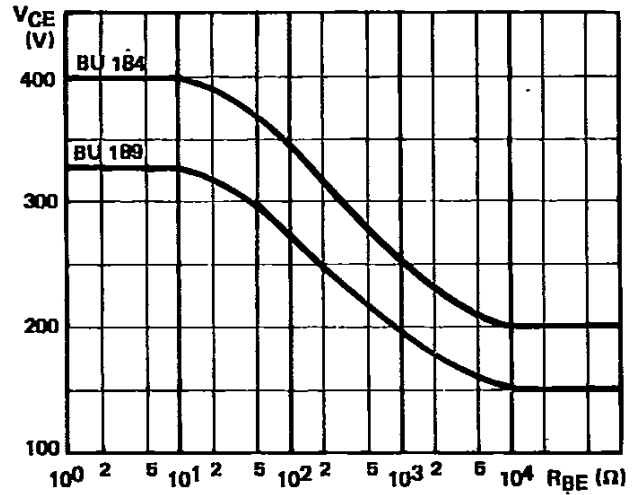

### Power and IS/B Derating vs Case Temperature.

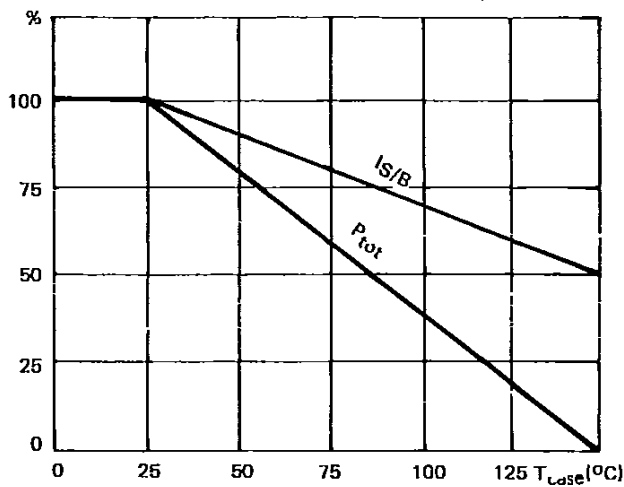

### Transient Thermal Response.

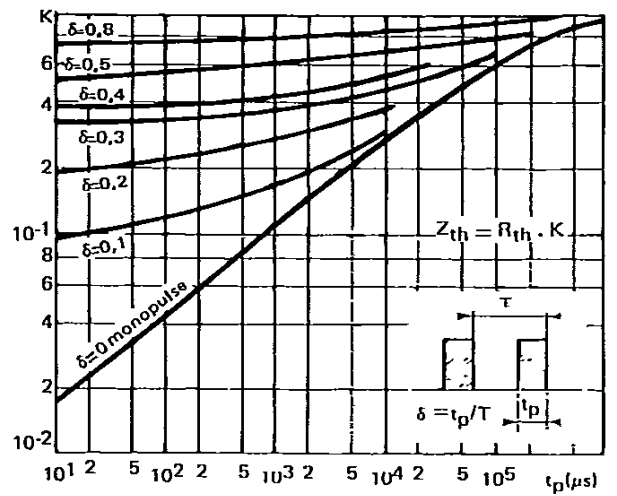

### DC Current Gain.

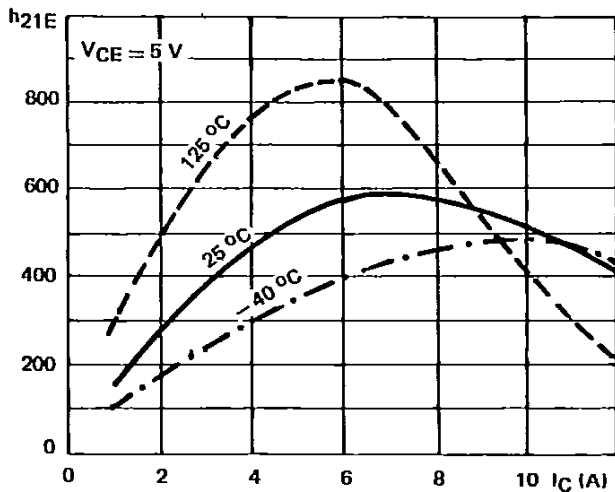

### Saturation Voltage.

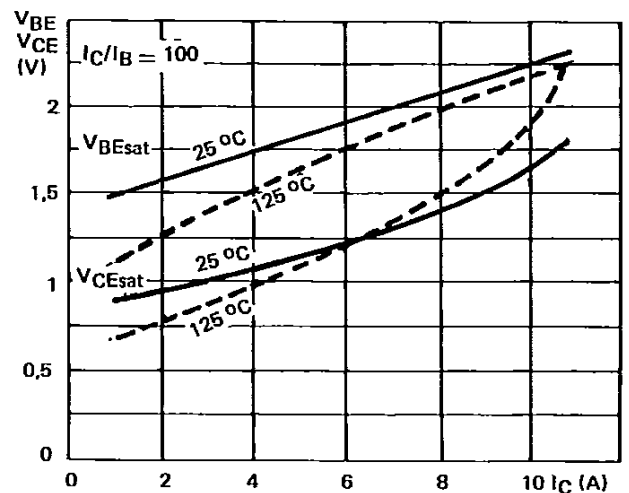

Base Characteristics.

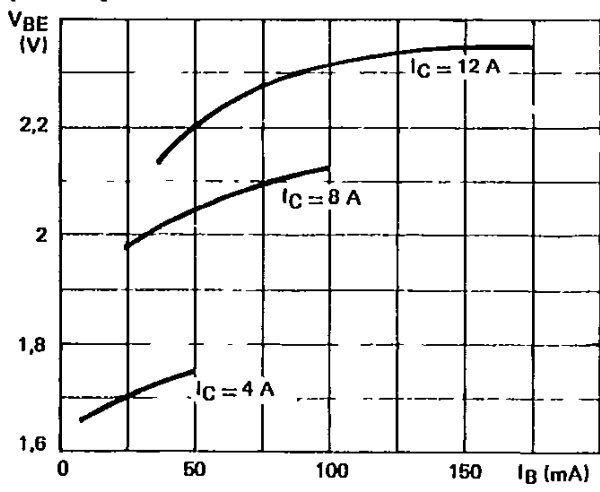

Collector Saturation Region.

