

Enhanced robustness and EMI resistance achieved by the laser-welded double-sided metal shell (SDHC card compatible, with card jump-out and wrong insertion prevention functions)

**SOCKETS FOR
SD MEMORY CARD (R TYPE)**

FEATURES

1. Superior EMI resistance and terminal coplanarity achieved by the double-sided metal shell

The laser-welded double-sided shell has high robustness and shielding performance. Providing a ground pattern when mounting the socket is effective for EMI protection.

The high resistance to reflow heat prevents the reflow process from degrading the terminal coplanarity.

2. The structures of the card detection and write protection switches prevent the card thickness from affecting the detection accuracy.

The side detection system and the highly dust-resistant V notch contact structure ensure high contact reliability.

3. Equipped with the card jump-out prevention function existence

4. Card locking structure for forced ejection protection

The lock pin in the metal shell prevents unwanted ejection of the card.

5. Compatible with the SDIO standard (with ground tab)

Compatible with the SDIO standard, allowing use for expansion modules with an interface function

APPLICATIONS

• DSCs, DVCs, PDAs, handheld terminals, notebook PCs, gaming consoles, car navigation systems, portable audio devices, etc. that use an SD card



Standard type



Reverse type

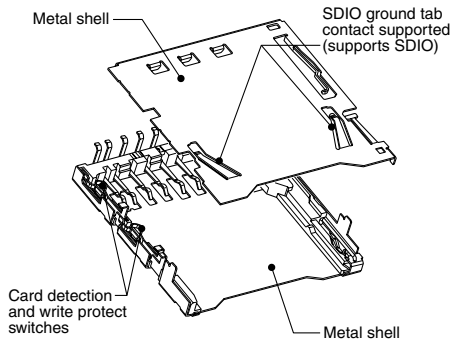

• What is V notch construction?

By making contact with the edges and thus increasing the contact pressure, this product can eliminate foreign matters more effectively than conventional products.

[Cross Section of Contacts]

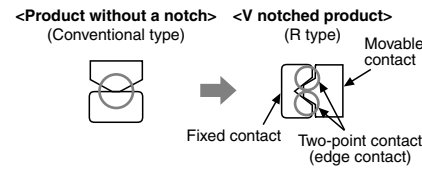

Compliance with RoHS Directive

ORDERING INFORMATION

AXA **2** **R** **3** **1**

2R: Sockets for SD memory card (R type)

<Board mounting direction>

6: On board mounting reverse type (outside terminal)

7: On board mounting standard type (outside terminal)

<Eject type>

3: Push-push type

<Standoff height>

0: Without standoff

3: Stand off 1.5 mm

<Function>

2: Without card jump-out prevention function, with card detection switch and with write protect switch

6: With card jump-out prevention function, with card detection switch and with write protect switch

<Terminal/Positioning boss>

1: SMD terminal/With positioning boss

<Packing>

T: 35 pcs. tray package × 20 trays

P: 350 pcs. embossed tape and paper reel package × 2 reels

PRODUCT TYPES

| Product name | Eject type | Card detection switch | Card jump-out prevention function | Mounting type | Standoff height (mm) | Part No. | Packing quantity | |
|-------------------------------------|----------------|-----------------------|-----------------------------------|------------------------|----------------------|-------------|---|---|
| | | | | | | | Inner carton | Outer carton |
| Sockets for SD memory card (R type) | Push-push type | Available | Available | Standard mounting type | 0 | AXA2R73061* | Asterisk "*" mark on end of Part No.; P: 350 pieces (1 reel) (Embossed tape package) T: 35 pieces (1 tray) (Tray package) | Asterisk "*" mark on end of Part No.; P: 700 pieces (2 reels) (Embossed tape package) T: 700 pieces (20 trays) (Tray package) |
| | | | | | 1.5 | AXA2R73361* | | |
| | | | | Reverse mounting type | 0 | AXA2R63061* | | |
| | | | Not available | Standard mounting type | 0 | AXA2R73021* | | |
| | | | | | 1.5 | AXA2R73321* | | |
| | | | | Reverse mounting type | 0 | AXA2R63021* | | |
| | | 1.5 | AXA2R63321* | | | | | |

SPECIFICATIONS

1. Characteristics

| Item | Specifications | Condition | |
|-------------------------------|---|---|---|
| Electrical characteristics | Rated Current | 0.5 A/1 terminal | |
| | Contact resistance | Signal contact portion: Max. 100mΩ (Initial) Detection contact portion: Max. 150mΩ (Initial) (Card detection and write protection detection) | Measured based on the HP4338B measurement method of JIS C5402 |
| | Insulation resistance | Min. 1,000MΩ (Initial) | Using 500V DC megger (applied for 1 min.) |
| | Breakdown voltage | 500V AC for 1 min. | Rated voltage is applied for one minute and check for short circuit or damage with a detection current of 1 mA. |
| Mechanical characteristics | Vibration resistance | Frequency: 10 to 55 Hz Acceleration: 20.0 m/s ² {2.0G} No current interruption for more than 0.1 μs | |
| | Card insertion force | Max. 40N | |
| | Card removal force | Min. 1N, Max. 40N | |
| Lifetime characteristics | Insertion and removal life: 10,000 times Contact resistance after testing: Signal contact portion: Max. 100mΩ Detection contact portion: Max. 150mΩ (Card detection and write protection detection) | Insertion and removal speed are at a rate of 600 times/hour or less. | |
| Environmental characteristics | Ambient temperature | -25°C to +90°C | No freezing or condensation in low temperatures |
| | Storage temperature | -40°C to +90°C (The allowable storage temperature is -40°C to +50°C if unopened from original packaging) | No freezing or condensation in low temperatures |
| | Resistance to soldering heat | Reflow soldering: peak temperature 250°C or less Hand soldering: Soldering iron temperature 300°C, 5 sec. or less | Sockets (shell) surface temperature for using infrared reflow soldering machine |
| | Humidity tolerance (mated condition) | Contact resistance: Signal contact portion: Max. 100mΩ Detection contact portion: Max. 150mΩ (Card detection and write protection detection) Insulation resistance: Min. 100 MΩ | MIL-STD-1344A, METHOD 1002 Temperature: 40±2°C, Humidity: 90 to 95%RH, Test time: 500 hours |
| Applicable memory card | SD memory card*1 | | |
| Unit weight | 2.9g | | |

Note: *1. The above characteristics cannot be guaranteed when a card other than the specified ones is used.

2. Material and surface treatment

| Portion | Material | Surface |
|----------------------|-----------------|--|
| Signal contact | Copper alloy | Contact portion: Ni plating on base, PdNi plating + Au flash plating Soldering portion: Ni plating on base, Au plating on surface |
| Detection contact | | Contact/Soldering portion: Ni plating on base, Au plating on surface |
| Retention solder tab | Stainless steel | Soldering portion: Ni strike, Partial Au plating |

DIMENSIONS (Unit: mm) The CAD data of the products with a **CAD Data** mark can be downloaded from: <http://panasonic-electric-works.net/ac>

1. On board mounting standard type (Without standoff)

Part No. DataSheet4U.com

AXA2R73061*
 (With card jump-out prevention function)
 AXA2R73021*
 (Without card jump-out prevention function)

CAD Data

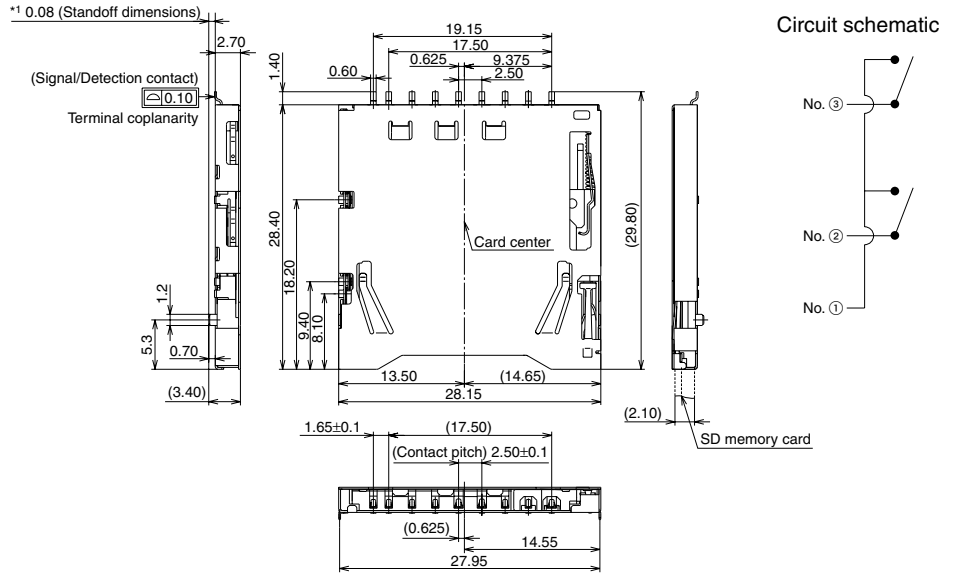
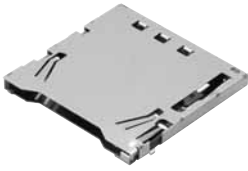

Detailed internal view

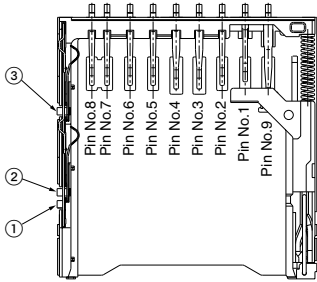

View of set card

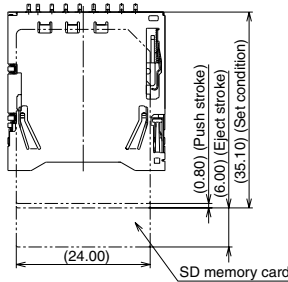

Recommended PC board pattern (TOP VIEW)

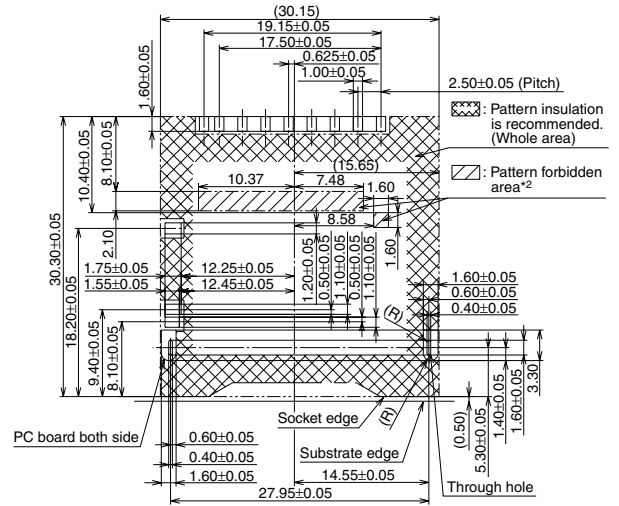

Contact status of the card detection and write protect switches

| Card attachment condition | Write protect switch | | Card detection switch |
|---------------------------|----------------------|--------------|-----------------------|
| | Write unable | Write enable | |
| Card not attached | Open | Open | Open |
| Card attached | Open | Closed | Closed |
| Terminal number | ①-② | | ①-③ |

*1 Standoff dimension is the dimension that takes into account the solder resist or silk screen printing thickness on the PC board in order to preserve the dimension from the surface of the PC board to the bottom of the socket.

*2 This is the pattern forbidden area. It is provided to prevent the signal contact tips from contacting the substrate surface.

Recommended metal mask pattern

Metal mask thickness: 120 μ m

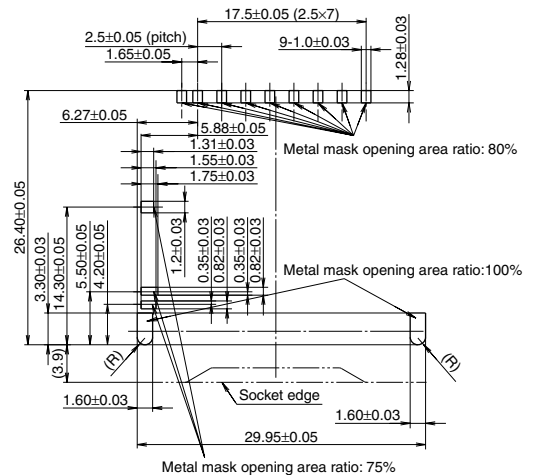

AXA2R

2. On board mounting standard type (Standoff 1.5mm)

Part No.
 AXA2R73361*
 (With card jump-out prevention function)
 AXA2R73321*
 (Without card jump-out prevention function)

CAD Data

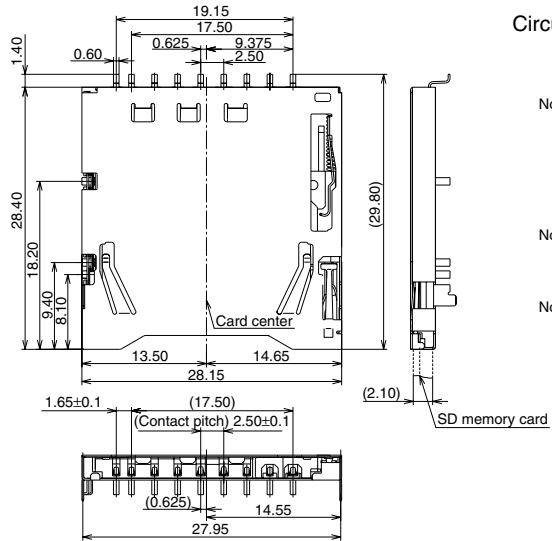
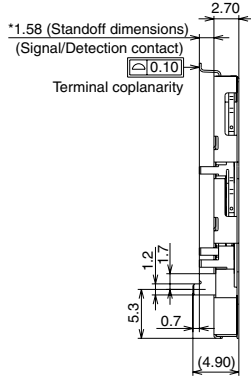
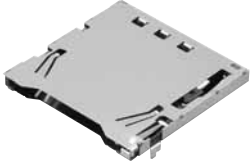

Circuit schematic

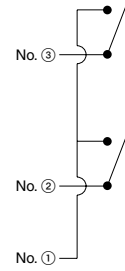

Detailed internal view

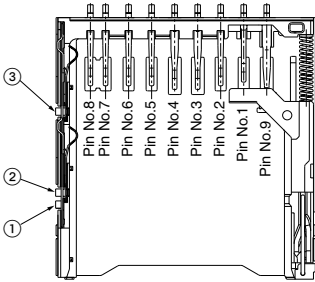

View of set card

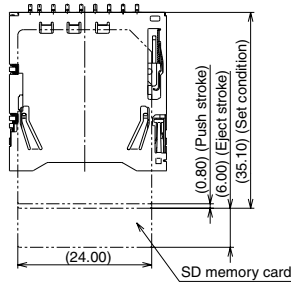

Recommended PC board pattern (TOP VIEW)

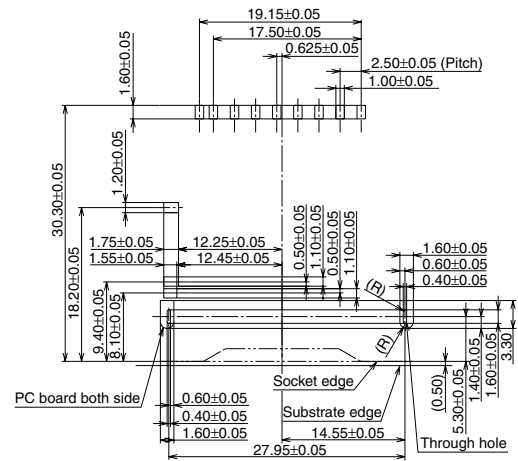

Contact status of the card detection and write protect switches

| Card attachment condition | Write protect switch | | Card detection switch |
|---------------------------|----------------------|--------------|-----------------------|
| | Write unable | Write enable | |
| Card not attached | Open | Open | Open |
| Card attached | Open | Closed | Closed |
| Terminal number | ①-② | | ①-③ |

* Standoff dimension is the dimension that takes into account the solder resist or silk screen printing thickness on the PC board in order to preserve the dimension from the surface of the PC board to the bottom of the socket.

Recommended metal mask pattern

Metal mask thickness: 120µm

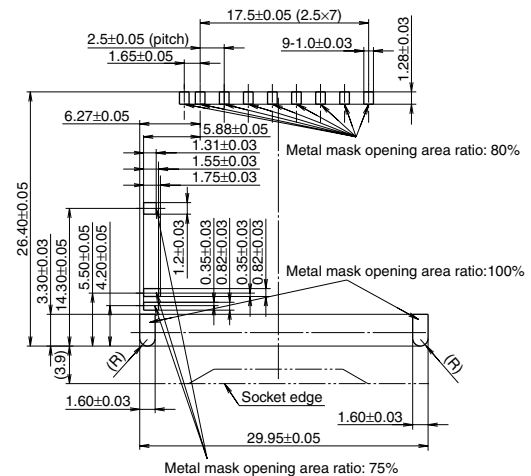

AXA2R

4. On board mounting reverse type (Standoff 1.5mm)

Part No.
 AXA2R63361*
 (With card jump-out prevention function)
 AXA2R63321*
 (Without card jump-out prevention function)

CAD Data

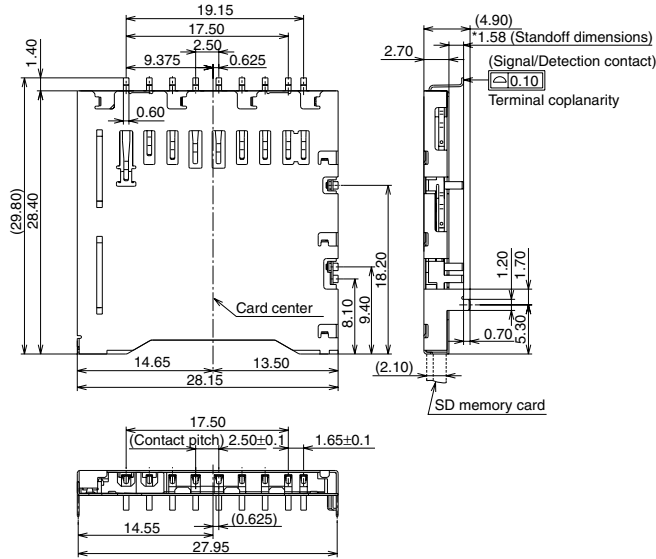
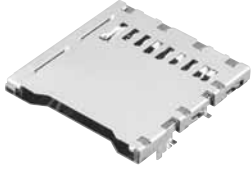

Circuit schematic

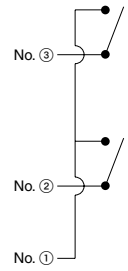

Detailed internal view

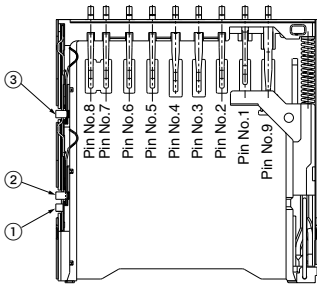

View of set card

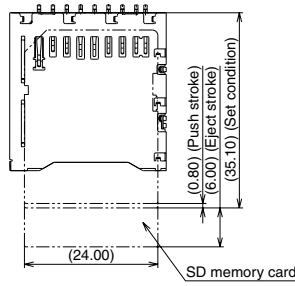

Recommended PC board pattern (TOP VIEW)

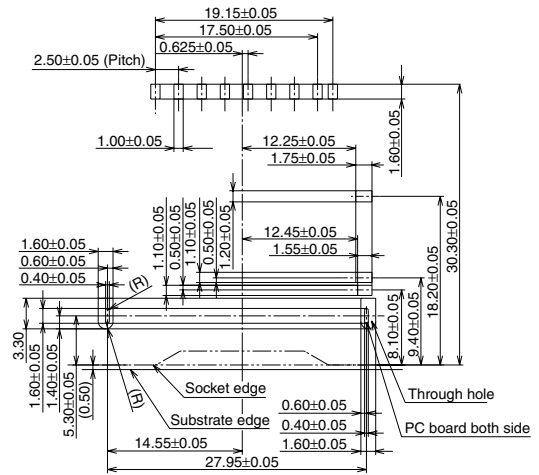

Contact status of the card detection and write protect switches

| Card attachment condition | Write protect switch | | Card detection switch |
|---------------------------|----------------------|--------------|-----------------------|
| | Write unable | Write enable | |
| Card not attached | Open | Open | Open |
| Card attached | Open | Closed | Closed |
| Terminal number | ①-② | | ①-③ |

* Standoff dimension is the dimension that takes into account the solder resist or silk screen printing thickness on the PC board in order to preserve the dimension from the surface of the PC board to the bottom of the socket.

Recommended metal mask pattern

Metal mask thickness: 120µm

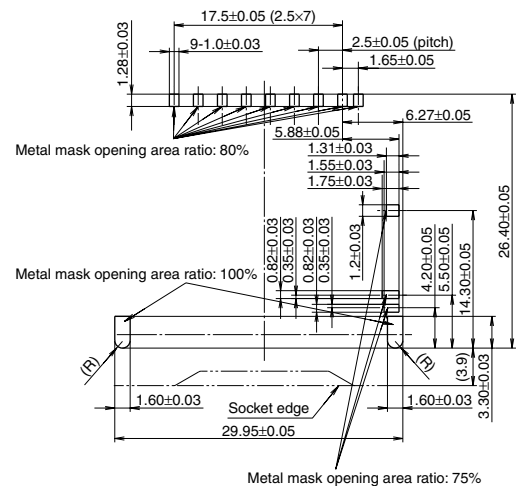

EMBOSED TAPE AND REEL (Unit: mm)

• Tape dimensions

www.DataSheet4U.com

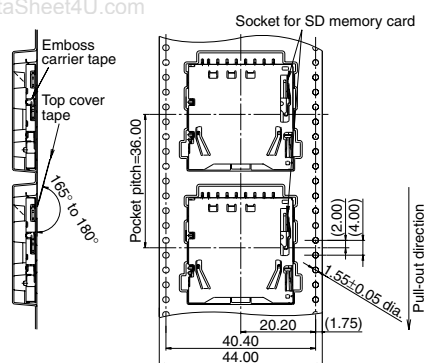

• Reel dimensions (Conforming to JIS C0806-1995)

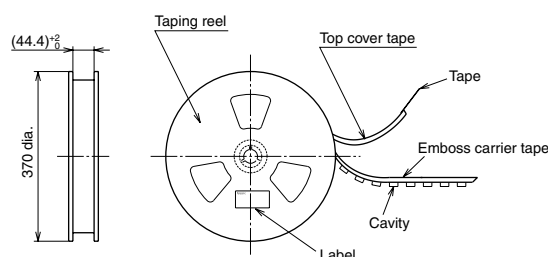

NOTES

1.Regarding the design of PC board patterns

Conduct the recommended foot pattern design, in order to preserve the mechanical strength of terminal solder areas.

2. Regarding the socket mounting

1) When reflow soldering when the slider is locked, heat will cause the slider to deform and not work. Therefore, please confirm that the slider lock is released before mounting if you have inserted and removed a card before soldering.

2) Be aware that during mounting, external forces may be applied to the connector contact surfaces and terminals and cause deformations.

3. Soldering

1) Reflow soldering

(1) Screen-printing method is recommended for cream solder printing.

(2) Use the recommended foot pattern for cream solder printing (screen thickness: 0.12 mm).

(3) The metal mask opening ratio for the COM contact (one) and NO contacts (two) must be 75%.

(4) When applying the different thickness of a screen, please consult us.

(5) The following diagram shows the recommended reflow soldering temperature profile.

The recommended conditions for the reflow temperature profile

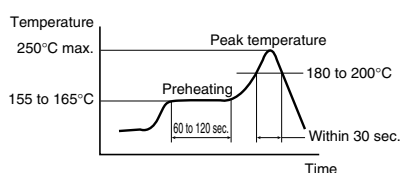

(6) Measure the temperature at the connector surface.

(7) If the reverse side of the board undergoes reflow soldering after the socket is reflow-soldered, fix the socket with tape or adhesive; otherwise, the socket may drop. The socket can withstand two iterations of reflow soldering.

2) Hand soldering

• Set the soldering tip to 300°C, and solder for no more than 5 seconds.

• Be aware that for the 0 mm standoff type, solder creeping at the retention solder tab sections may occur if soldering is conducted for long periods or if too much solder is used.

4. Cleaning after soldering

Inside the socket there is a slider section and card detection contact/write protection mechanism. If anything such as flux remains inside after washing, insertion and removal will be hampered and contact will be faulty. Therefore, do not use methods that involve submersion when cleaning. (Partial cleaning of the PC board and soldered terminals is possible.)

5. After PC board mounting

1) Warping of the PC board should be no more than 0.03 mm for the entire connector length.

2) When assembling PC boards or storing them in block assemblies, make sure that undue weight is not exerted on a stacked socket.

3) Be sure not to allow external pressure to act on sockets when assembling PC boards or moving in block assemblies.

6. Handling single components

1) Make sure not to drop or allow parts to fall from work bench

2) Be cautious when handling because excessive force applied to the terminals will cause deformation and loss of terminal coplanarity.

3) Repeated bending of the terminals may break them.

7. Card fitting

1) These products are made for the design of compact and lightweight devices and therefore the molded part is very thin. For this reason, design the device to prevent undue wrenching forces from being applied to the product during use.

2) The sockets are constructed to prevent reverse card insertion. Caution is required because repeated, mistaken reverse insertion may damage the socket and card.

3) When not soldered, be careful not to insert and remove the socket's card. Doing so will cause a decrease in anchoring ability of the molded part and loss of coplanarity.

4) Forcibly removing a fitted card may degrade the card removal prevention lock. To remove a card, be sure to push the card in the insertion direction to release the slider lock before pulling out the card.

5) Please include notes to the following effect in your user manuals.

6) The card ejection protection lock does not work for MMC.

7) The socket does not have a wrong insertion protection structure for MMC. Be careful about the insertion direction.

8) If an MMC is inserted, it is possible that a short circuit between the socket's signal contacts No. 7 and 8 and the MMC's contact No. 7 may be caused.

AXA2R

8. Device design

1) Contact failure may result if dust or dirt enters the contact section. Please take appropriate measures when designing the device to prevent this from happening, for example by adding a cover.

2) To ensure smooth insertion and removal of cards, please design the chassis so that no force is applied to the metal shell on top of the socket. If a force is present that pushes down on the metal shell, the card will be pressed, which might prevent ejection.

3) Please provide a guide or similar to keep the socket from having force applied to it when inserting and removing.

9. Card jump-out prevention function

1) This socket has a card jump-out prevention function that works under defined conditions. However, we strongly recommend that you instruct users to carefully handle the product to avoid accidents due to improper use or product liability risks.

2) The life of the card jump-out prevention function is not guaranteed under the following conditions: (1) while the card is inserted incompletely, (2) while the card is inserted in the wrong direction, and (3) after the card is inserted in the wrong direction

3) In order to prevent card jump-out, resistance has been added that affects card insertion and removal. Therefore, you will feel resistance when inserting and removing the card. This is normal.

10. Others

If you coat the PC board after soldering for insulation and to prevent wear, make sure that the coating does not adhere to the connector.

For other details, please verify with the product specification sheets.