

PLEASE CHECK WWW.MOLEX.COM FOR LATEST PART INFORMATION

Part Number: [0679260401](#)
Status: **Active**
Description: 3.81mm (.150") Pitch Serial ATA IDT Power Receptacle, Gold (Au) Flash, 22AWG, with Latch, without Bump, Lead free

Documents:

[3D Model](#)
[Drawing \(PDF\)](#)

[RoHS Certificate of Compliance \(PDF\)](#)

General

Product Family	IDT and Solder Connectors
Series	67926
Crimp Quality Equipment	Yes
Product Name	Serial ATA
Use With	67926-0040 Feed-to Cover, 67926-0041 Feed-Through Cover

Physical

Circuits (Loaded)	5
Color - Resin	Black
Durability (mating cycles max)	50
Gender	Female
Glow-Wire Compliant	No
Lock to Mating Part	Yes
Material - Metal	Copper Alloy
Material - Plating Mating	Gold
Material - Plating Termination	Tin
Number of Rows	1
Packaging Type	Tray
Panel Mount	No
Pitch - Mating Interface (in)	0.150 In
Pitch - Mating Interface (mm)	3.81 mm
Pitch - Term. Interface (in)	0.150 In
Pitch - Term. Interface (mm)	3.81 mm
Plating min: Mating (µin)	2
Plating min: Mating (µm)	0.05
Plating min: Termination (µin)	75
Plating min: Termination (µm)	1.90
Polarized to Mating Part	Yes
Temperature Range - Operating	-35°C to +85°C
Wire Size AWG	22

Electrical

Current - Maximum per Contact	1.5A
Voltage - Maximum	15V DC

Material Info

Reference - Drawing Numbers

Sales Drawing	SD-67926-001
---------------	--------------

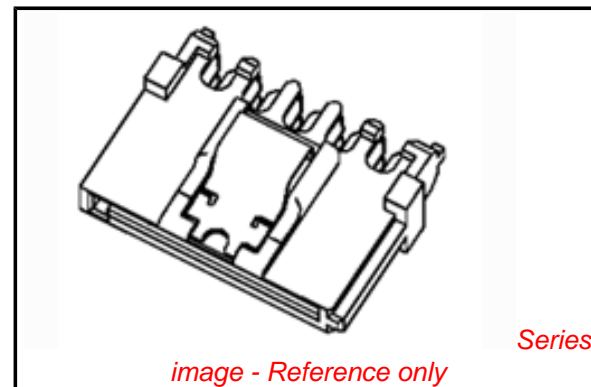

EU RoHS

**ELV and RoHS
Compliant**
**REACH SVHC
Not Reviewed**
**Halogen-Free
Status**

China RoHS



**Need more information on product
environmental compliance?**

Email productcompliance@molex.com
 For a multiple part number RoHS Certificate of Compliance, [click here](#)

Please visit the [Contact Us](#) section for any non-product compliance questions.

Search Parts in this Series

[67926Series](#)

Mates With

[87679](#)

Application Tooling | FAQ

Tooling specifications and manuals are found by selecting the products below. Crimp Height Specifications are then contained in the Application Tooling Specification document.

Global

Description	Product #
Insertion Tool for 3.96mm (.156") Pitch KK® IDT Crimp Terminals	0638133503

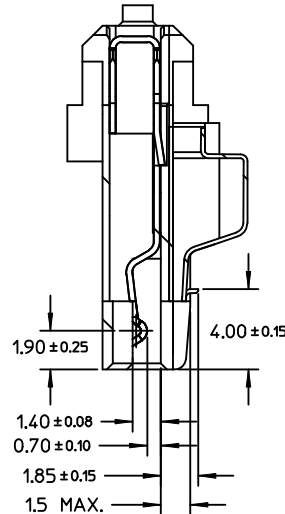
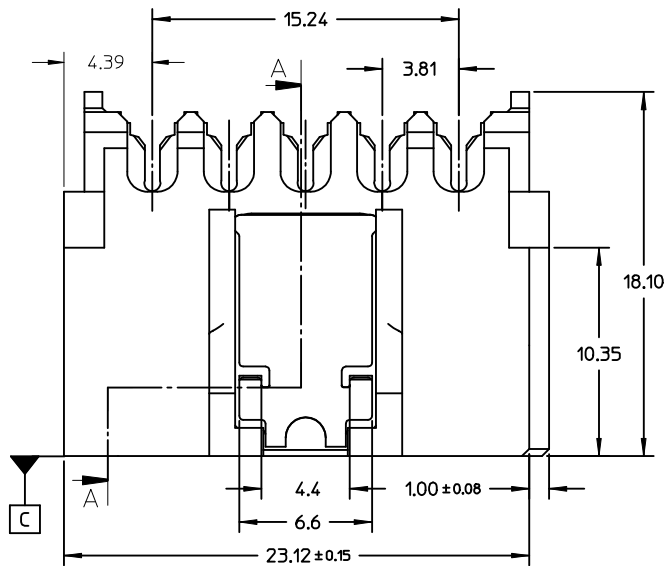

SECTION A-A

NOTES:

1. MATERIAL:
 - HOUSING: THERMAL PLASTIC, G.F., UL94V-0, COLOR: BLACK
 - COVER: THERMAL PLASTIC, COLOR: BLACK
 - TERMINAL: COPPER ALLOY
 - METAL LATCH: STAINLESS STEEL
2. TERMINAL PLATING:
 - CONTACT AREA: GOLD PLATED
 - IDT TAIL: PLATE TIN, 1.9 MICRONS MINIMUM
 - UNDER PLATE: PLATE NICKEL 1.25 MICRONS MINIMUM
3. PACKAGING: TRAY
4. PRODUCT SPECIFICATION REFER TO PS-67490-001
5. ASSEMBLE WITH COVER 679260040/0041 AFTER WIRE TERMINATION
6. MATING PART 87679
7. RECOMMENDED TERMINATING WIRE SIZE: SEE TABLE
8. PRODUCT COMPLIANT TO RoHS DIRECTIVE 2002/95/EC AND ELV DIRECTIVE 2000/53/EC

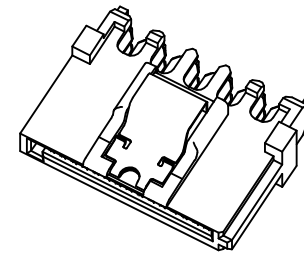

WITH LATCH TYPE

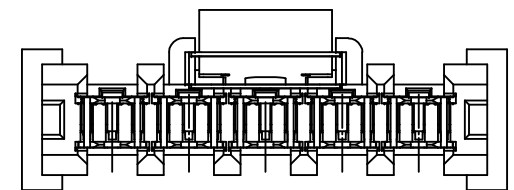
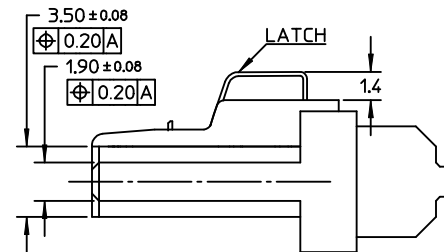
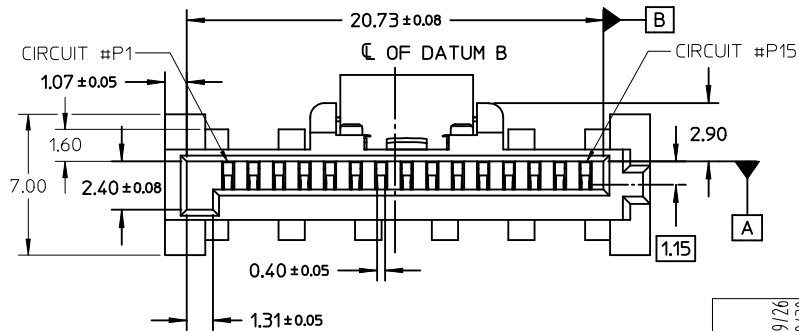

REVISED EC NO: SH2009-0098 DRW: CWTANG CHK: XJSONG APPR: HWANG	DESCRIPTION 2008/09/26 2008/09/30 2008/11/01	QUALITY SYMBOLS	GENERAL TOLERANCES (UNLESS SPECIFIED)		DIMENSION STYLE		SCALE	DESIGN UNITS	THIRD ANGLE PROJECTION	
		▽=0 ◻=0	mm	INCH	MM ONLY	4:1	METRIC	SERIAL ATA POWER CONNECTOR IDT TYPE		
		4 PLACES ± --- ± --- 3 PLACES ± --- ± --- 2 PLACES ± 0.25 ± --- 1 PLACE ± 0.3 ± ---	DRAWN BY DATE		TITLE					
		ANGULAR ± 1°	DRAFT WHERE APPLICABLE MUST REMAIN WITHIN DIMENSIONS		MATERIAL NO.		DOCUMENT NO.		MOLEX INCORPORATED SD-67926-001 SHEET NO. 1 OF 3	
SEE CHART	THIS DRAWING CONTAINS INFORMATION THAT IS PROPRIETARY TO MOLEX INCORPORATED AND SHOULD NOT BE USED WITHOUT WRITTEN PERMISSION		SIZE A3							

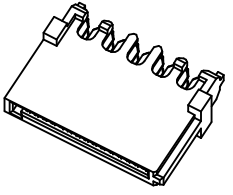
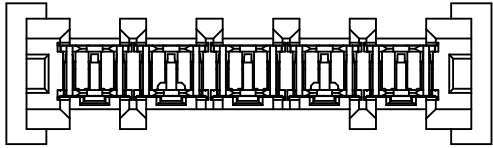

WITHOUT LATCH TYPE

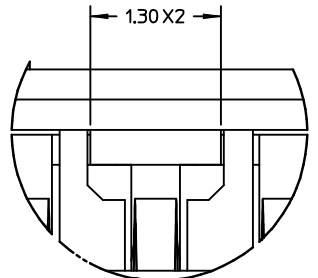
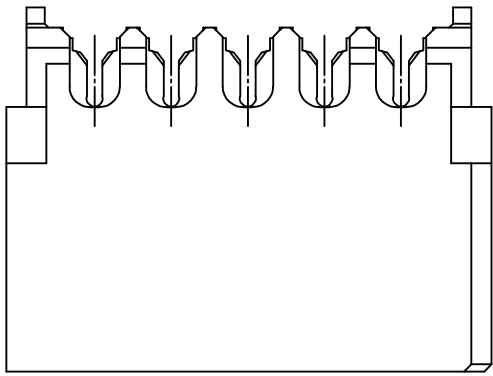

Detail2

SCALE 20:1

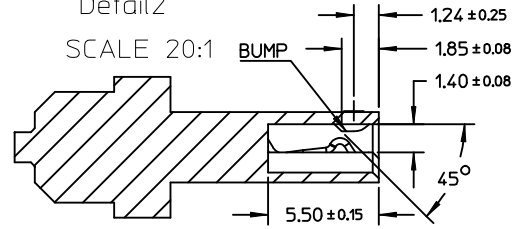

SECTION B-B

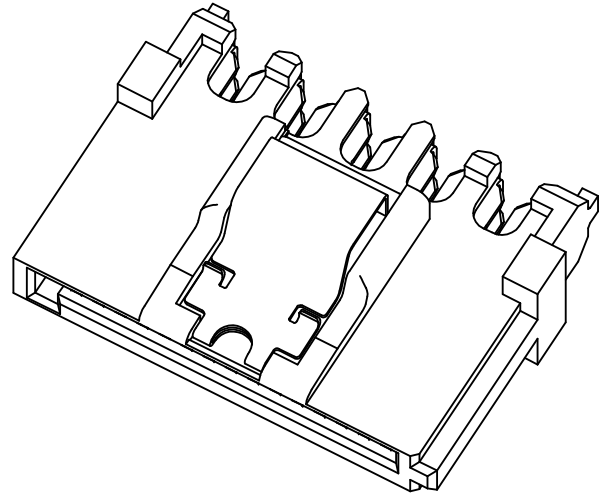
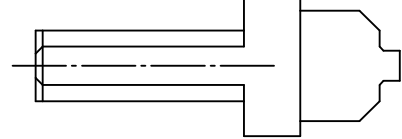

See Detail2

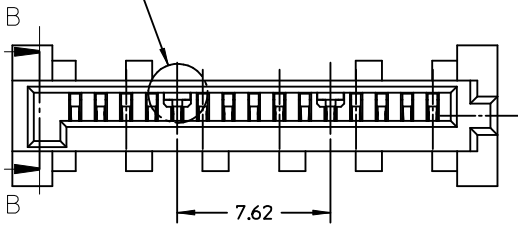

NOTES:
OTHER INFORMATION REFER TO SHEET 1

REVISED EC NO: SH2009-0098 G DRWIN: CWTANG CHKD: XJSONG APPR: HWANG	2008/09/26 2008/09/30 2008/11/01	DESCRIPTION REV	QUALITY SYMBOLS ▽=0 ◻=0	GENERAL TOLERANCES (UNLESS SPECIFIED) mm INCH	DIMENSION STYLE MM ONLY	SCALE 4:1	DESIGN UNITS METRIC	THIRD ANGLE PROJECTION
			4 PLACES ± --- ± --- 3 PLACES ± --- ± --- 2 PLACES ± 0.25 ± --- 1 PLACE ± 0.3 ± ---	DRAWN BY DATE GRATE MA 2004/01/17 CHECKED BY DATE YAJUN 2004/01/17 APPROVED BY DATE SAM 2004/01/17	TITLE SERIAL ATA POWER CONNECTOR IDT TYPE			
			ANGULAR ± 1 °	MATERIAL NO. SEE CHART	DOCUMENT NO. SD-67926-001	SHEET NO. 2 OF 3		
			DRAFT WHERE APPLICABLE MUST REMAIN WITHIN DIMENSIONS	SIZE A3	THIS DRAWING CONTAINS INFORMATION THAT IS PROPRIETARY TO MOLEX INCORPORATED AND SHOULD NOT BE USED WITHOUT WRITTEN PERMISSION			

P/N	RECOMMENDED WIRE SIZE	PLATE TYPE	REMARK
67926-0001	18AWG	GOLD FLASH	WITH LATCH,WITHOUT BUMP
67926-0301	20AWG		
67926-0401	22AWG		
67926-0002	18AWG	0.76 MICRON GOLD PLATED	
67926-0302	20AWG		
67926-0402	22AWG		
67926-0005	18AWG	0.38 MICRON GOLD PLATED	
67926-0305	20AWG		
67926-0405	22AWG		
67926-0021	18AWG	GOLD FLASH	WITH LATCH,WITH BUMP
67926-0321	20AWG		
67926-0421	22AWG		
67926-0022	18AWG	0.76 MICRON GOLD PLATED	
67926-0322	20AWG		
67926-0422	22AWG		
67926-0025	18AWG	0.38 MICRON GOLD PLATED	
67926-0325	20AWG		
67926-0425	22AWG		
67926-0011	18AWG	GOLD FLASH	WITHOUT LATCH,WITH BUMP
67926-0311	20AWG		
67926-0411	22AWG		
67926-0012	18AWG	0.76 MICRON GOLD PLATED	
67926-0312	20AWG		
67926-0412	22AWG		
67926-0015	18AWG	0.38 MICRON GOLD PLATED	
67926-0315	20AWG		
67926-0415	22AWG		

REVISED EC NO: SH2009-0098 DRWN: CWTANG CHKD: XJSONG APPR: HWANG	2008/09/26 2008/09/30 2008/11/01	DESCRIPTION REV	QUALITY SYMBOLS	GENERAL TOLERANCES (UNLESS SPECIFIED)	DIMENSION STYLE	SCALE	DESIGN UNITS	THIRD ANGLE PROJECTION	
			▼=0 □=0	mm INCH	MM ONLY	4:1	METRIC	DRAWN BY DATE GRATE MA 2004/01/17	
			4 PLACES ± --- ± --- 3 PLACES ± --- ± --- 2 PLACES ± 0.25 ± --- 1 PLACE ± 0.3 ± ---	CHECKED BY DATE YA JUN 2004/01/17	SERIAL ATA POWER CONNECTOR IDT TYPE				
			ANGULAR ± 1 °	APPROVED BY DATE SAM 2004/01/17	MOLEX INCORPORATED				
DRAFT WHERE APPLICABLE MUST REMAIN WITHIN DIMENSIONS				MATERIAL NO. SEE CHART	DOCUMENT NO. SD-67926-001	SHEET NO. 3 OF 3			
				SIZE A3	THIS DRAWING CONTAINS INFORMATION THAT IS PROPRIETARY TO MOLEX INCORPORATED AND SHOULD NOT BE USED WITHOUT WRITTEN PERMISSION				