



Evaluation Board for Microprocessor System Temperature Monitor

EVAL-ADM1022

FEATURES

External Temperature Measurement with Remote Diode (Two Channels)
On-Chip Temperature Sensor
Interrupt and Overtemperature Outputs
Fault Tolerant Fan Control
Brownout Detection
LDCM Support
I²C Compatible System Management Bus (SMBus)
Standby Mode to Minimize Power Consumption
Limit Comparison of all Monitored Values

APPLICATIONS

Network Servers and Personal Computers
Microprocessor-Based Office Equipment
Test Equipment and Measuring Instruments

INTRODUCTION

The ADM1022 Evaluation Board allows the ADM1022 microprocessor system hardware monitor IC to be easily evaluated using a personal computer. Using both the evaluation board and its accompanying software, the ADM1022 can be interfaced to any personal computer running WindowsTM 95 or WindowsTM 98, via the computer's parallel printer port, or via the computer's SMBus using the DIMM interface card provided.

The evaluation board allows all the input and output functions of the ADM1022 to be exercised without the need for external components. The software allows control and monitoring of the ADM1022's internal registers.

THE ADM1022

The following gives a brief description of the ADM1022. More detailed device information can be found in the datasheet for the device. The ADM1022 is a hardware temperature monitor for personal computers and other microprocessor systems which features a three-channel digital thermometer and over-temperature alarm. It can also control the speed of a cooling fan.

The device can measure local temperature using an on-chip diode connected transistor, or can use low cost, small signal transistors such as the 2N3904 or 2N3906 to measure the temperatures of 2 external microprocessors. The measurement technique implemented, cancels the absolute value of the transistor's base emitter voltage, so that no calibration is required.

EVALUATION SYSTEM PACKAGE CONTENTS

The evaluation system package contains the following items:

- * This application note
- * ADM1022 evaluation board
- * DIMM interface card
- * Centronics cable
- * DIMM interface ribbon cable
- * Evaluation software on floppy disks

EVALUATION BOARD HARDWARE

The ADM1022 evaluation board contains the following main components, which can be identified from the block diagram, printed circuit board silk screen and schematic diagram of figures 1, 2 and 3 overleaf.

- * ADM1022 I.C.
- * NPN and PNP sensor transistors
- * LED indicators for power, resets, interrupt, over-temperature, fan off request, and fan full-on
- * Switches for selecting voltage monitoring source, temperature sensors, and for setting device's SMBus address
- * Interface buffers
- * Connectors for parallel and SMBus interface
- * Test connector
- * 3.3V supply regulation circuit

REQUIREMENTS

- * PC running Windows 95 or Windows 98
- * 15Vdc 300mA regulated power supply

REV. B

Information furnished by Analog Devices is believed to be accurate and reliable. However, no responsibility is assumed by Analog Devices for its use, nor for any infringements of patents or other rights of third parties which may result from its use. No license is granted by implication or otherwise under any patent or patent rights of Analog Devices.

One Technology Way, P.O. Box 9106, Norwood, MA 02062-9106, U.S.A.
Tel: 781/329-4700 World Wide Web Site: <http://www.analog.com>
Fax: 781/326-8703 Analog Devices, Inc., 1998

EVAL-ADM1022

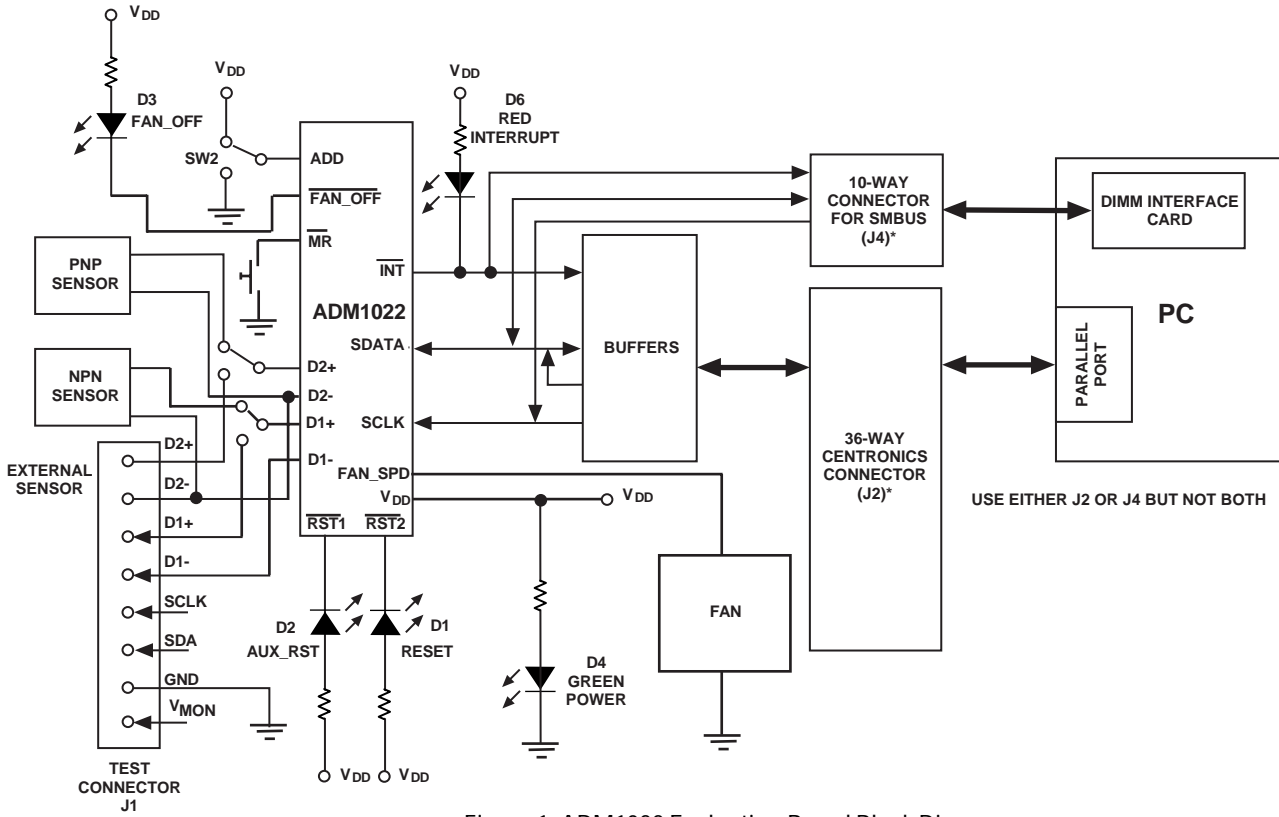

Figure 1. ADM1022 Evaluation Board Block Diagram

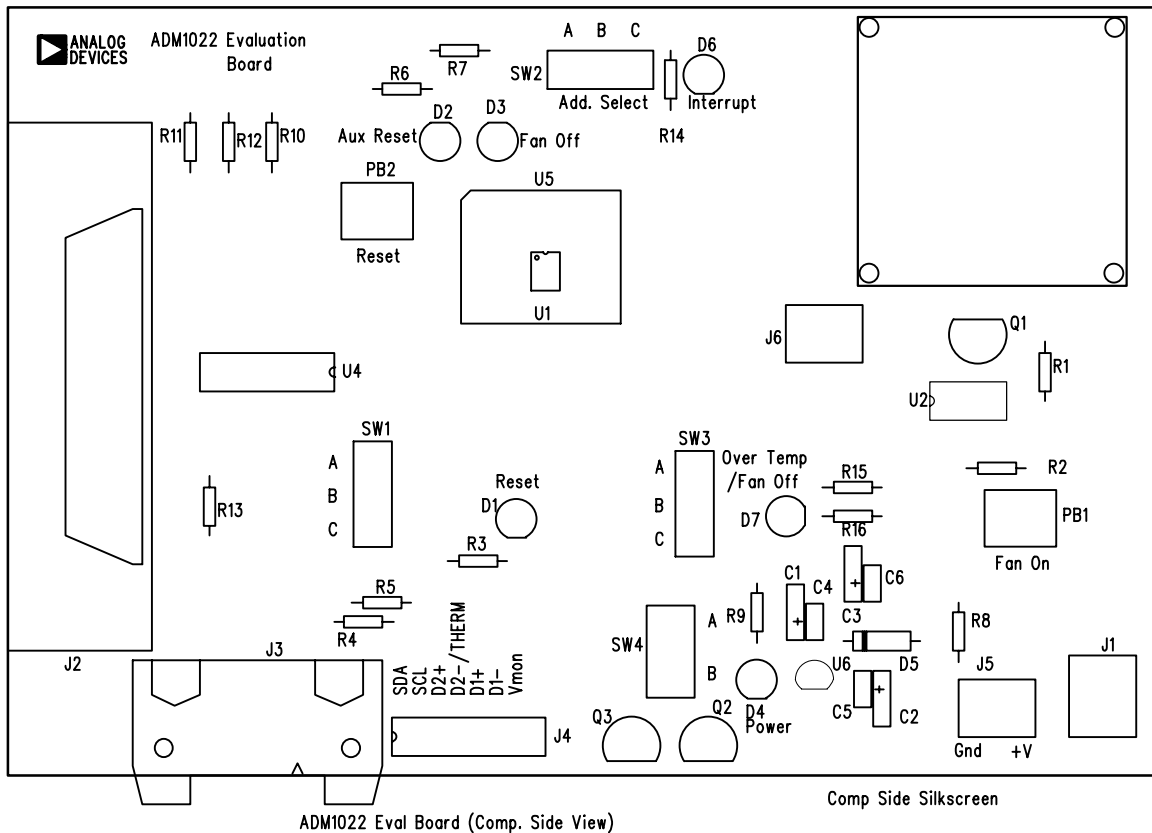
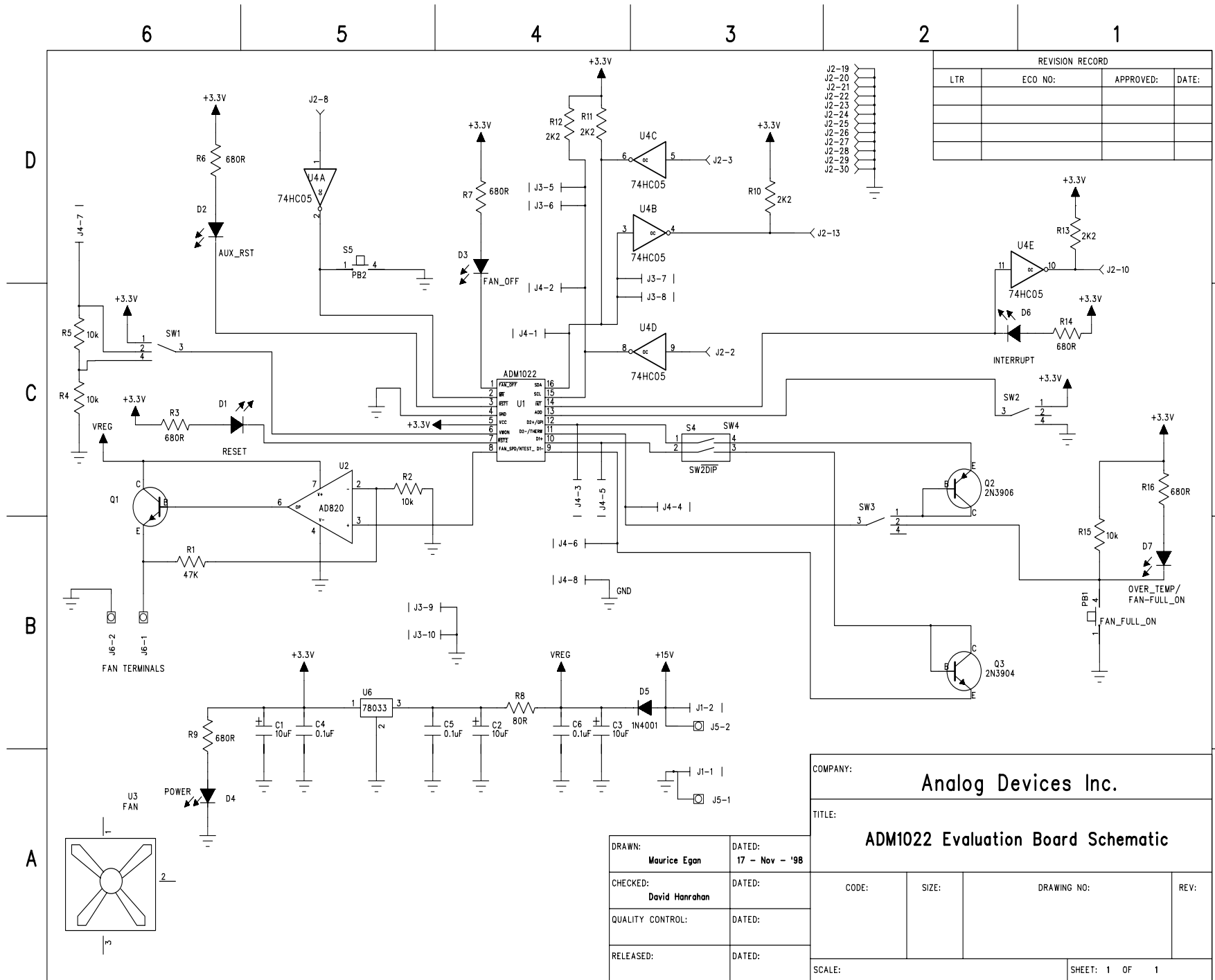

Figure 2. ADM1022 Evaluation Board SilkScreen

REV. B

-3-



REVISION RECORD			
LTR	ECO NO:	APPROVED:	DATE:

COMPANY:			
Analog Devices Inc.			
TITLE:			
ADM1022 Evaluation Board Schematic			
DRAWN:	DATED:	CODE:	REV:
Maurice Egon	17 - Nov - '98		
CHECKED:	DATED:	DRAWING NO:	
David Hanrahan			
QUALITY CONTROL:	DATED:		
RELEASED:	DATED:	SCALE:	SHEET: 1 OF 1

EVAL-ADM1022

EVAL-ADM1022

CONNECTORS, SWITCHES AND INDICATORS

The function of the various connectors, switches and indicators on the evaluation board is explained below.

TEST CONNECTOR J4

Test connector J4 allows the serial data and clock lines of the ADM1022 and the $\overline{\text{THERM}}$ line to be monitored. The connector also allows access to the V_{MON} and GPI lines.

Alternative external diode sensors may be connected between the D1 and D2 pairs of inputs.

CENTRONICS INTERFACE CONNECTOR J2

If the personal computer being used with the evaluation board does not have a System Management Bus on the motherboard, connection between the evaluation board should be made via a parallel printer port, using the cable provided. The connections to J2 are as follows:

TABLE 1. J2 CONNECTIONS

J2 Pin	ADM1022 Function	Parallel Port Function
2	Serial Clock (SCLK)	DB0
3	Serial Data In (SDA)	DB1
8	Manual Reset (MR)	DB6
10	Interrupt (INT)	ACK
13	Serial Data Out (SDA)	SLCT
19-30	Gnd	Gnd

SMBUS INTERFACE CONNECTOR J3

The SMBus interface connector J3 allows the evaluation board to be connected directly to the SMBus of a personal computer, using the DIMM interface card provided. To make this connection, it may be necessary to remove one of the DIMM memory modules on the PC motherboard, if all DIMM sockets are occupied. This will affect the BIOS setup and Windows 95, and should only be attempted by a competent user.

REMOTE SENSOR SELECT SWITCHES SW4, SW3

Two remote sensors are provided on the evaluation board; a 2N3904 and a 2N3906 transistor. Alternative remote sensors may be connected between the D1 and D2 terminals on the test connector J4.

TABLE 2. REMOTE SENSOR SELECT; SW4, SW3

SW4 Position		SW3 Position	Sensor Selected
1	2		
OFF	OFF	C	D1/D2 (connector J4)
ON	-	A	2N3906 (D2)
-	ON	-	2N3904 (D1)
ON	ON	A	D1 and D2 selected

SERIAL BUS ADDRESS SELECT (SW2)

SW2 is used to set the two LSB's of the ADM1022's serial bus address, A1 and A0. The ADD pin is tri-state and can be grounded, left unconnected or tied to V_{CC} . This means a total of three addresses are possible. It should be noted that the ADD pin is only read at power-up. If SW2 is changed while the ADM1022 is on, the change of address will not be effective until the device has been powered off, and on again.

As the serial bus address is 7 bits, when storing it as an 8-bit word it must be left or right justified, with either the MSB or the LSB of the 8-bit word as zero. The ADM1022 evaluation software stores the 7-bit serial bus address as left-justified and makes the LSB zero. Table 3 shows the three possible addresses for the ADM1022.

TABLE 3. ADM1022 DEVICE ADDRESSES

SW2 Position	A1	A0	Device Address
A (Gnd)	1	0	5C (Hex)
B (NC)	0	0	58 (Hex)
C (V_{CC})	0	1	5A (Hex)

V_{MON} SELECT SWITCH, SW1

This switch allows the V_{MON} pin to monitor either the on-board 3.3V supply, an external 3.3V supply through connector J4, or a larger external supply voltage through J4, applied across voltage divider network R4, R5. Table 4 shows the relevant switch positions.

TABLE 4. V_{MON} SELECT SWITCH, SW1

SW1 Position	Voltage Source (V_{mon})
A	External 5V on J4
B	External 3.3V on J4
C	On-board 3.3V

D2/ $\overline{\text{THERM}}$ SELECT SWITCH, SW3

This switch selects either the on-board 2N3906 temperature sensing transistor, or an off-board transistor connected to the D2 inputs of test connector J4.

If a second thermal diode is unwanted, the $\overline{\text{THERM}}$ function on the ADM1022 may be used. If THERM is selected, LED D7 will indicate any over-temperature measurements.

TABLE 5. D2/ $\overline{\text{THERM}}$ SWITCH, SW3

SW3 Position	Selected Function
A	Remote D2 on J4
B	Over-temperature and fan full-on status on LED D7
C	On-board 2N3906

RESET SWITCH, PB2

When this pushbutton switch is pressed, it will assert $\overline{\text{RST2}}$ low. $\overline{\text{RST2}}$ will remain low for t_{rp} after PB2 is released. This can be used to reset some external circuitry.

FAN FULL-ON SWITCH, PB1

When this pushbutton switch is pressed, $\overline{\text{THERM}}$ is pulled low. This causes the FAN_SPD output to go full-scale (2.5V), and the fan goes to full speed. The FAN FULL-ON LED, D7 also lights up.

TABLE 6. INDICATOR LED'S

LED	WHEN LIT
D1	When $\overline{\text{RST2}}$ asserts on power-up or PB2 is pressed.
D2	When $\overline{\text{RST1}}$ asserts on power-up.
D3	When $\overline{\text{FAN_OFF}}$ output is asserted.
D4	When board is powered.
D6	When an interrupt condition occurs.
D7	When an over-temperature condition occurs ($\overline{\text{THERM}}$ asserted), or when the fan is set to full speed by pressing PB1.

THE SOFTWARE

The software allows the ADM1022's functions to be controlled from the PC via an easy to use interface, operating under the Windows environment. The contents of the device's internal registers can easily be read or altered through a user-friendly graphical interface, while the Visual Display window allows temperature readings to be graphed.

INSTALLING THE SOFTWARE

To install the software, insert the first disk of the program software supplied into drive A, click on the Start icon, click on Run, and then type A:setup.exe as the file name. If the 3.5-inch floppy disk drive is not drive "A", type "X" instead of "A", where "X" is the drive letter of the 3.5-inch floppy disk drive.

USING THE SOFTWARE

When using the software, first ensure that the evaluation board is connected to the Parallel printer port, or to the PC's SMBus using the DIMM interface card.

To start the software, select Start- Programs- ADM1022 Evaluation Software.

When the program is started, the Software Initialisation Wizard screen will appear.

EVAL-ADM1022

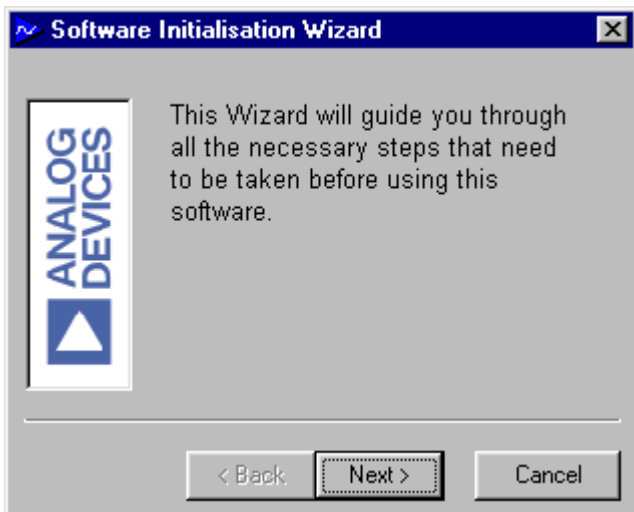

Click on “Next” to go on to the next screen, which allows the user to select between connection of the evaluation board via the printer port or to the SMBus using the DIMM interface card.

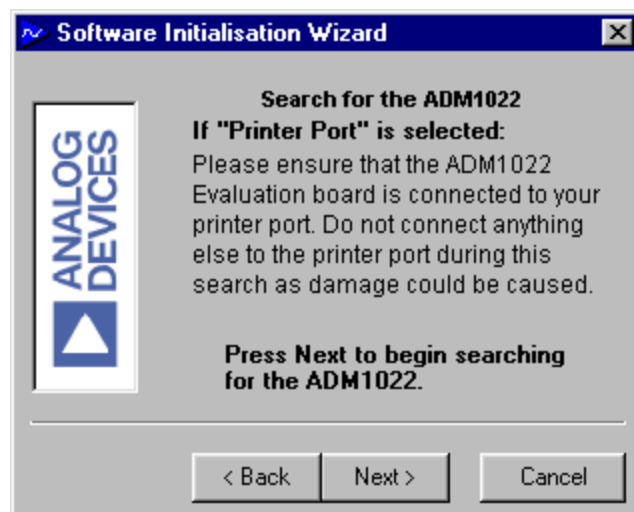

The software will search for the ADM1022, and when it is found, the following screen will appear. The device address found will depend on the setting of Address Select switch, SW2.

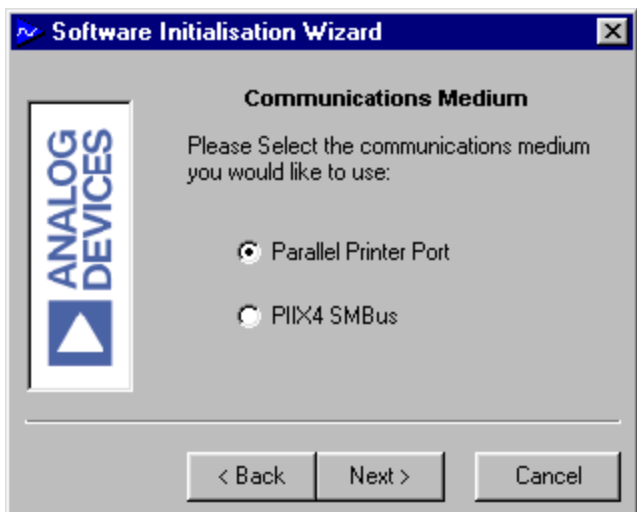

Once the communications medium has been selected, click on “Next” to go to the next screen. When you are ready for the software to begin searching for the evaluation board on either the parallel port or the SMBus, click “Next”.

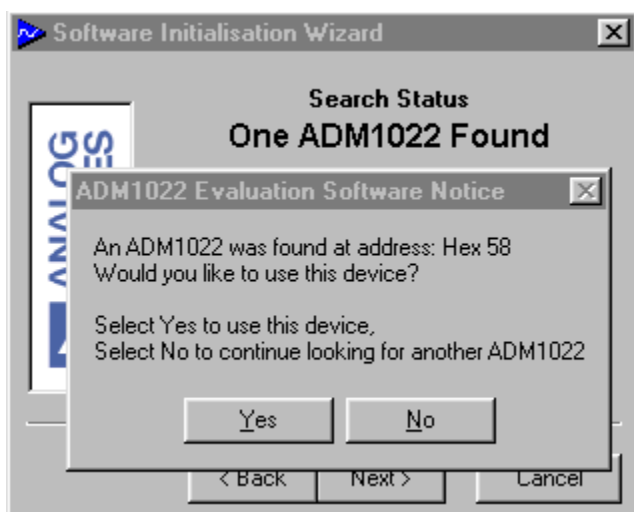

If “Yes” is selected, then the following message appears. If “No” is chosen, then the software will search for another ADM1022 device at a different address. This feature is useful if multiple ADM1022’s exist on the same SMBus and you need access to one of the devices at a different address.



In this case, check the connections to the evaluation board, click on “< Back” and try again. If this does not work, then try re-booting the PC and re-running the software.

When the software has successfully found the ADM1022, click on “Finish”. An index-card type display with three tabs will appear.

The main tab is the splash screen. It shows the software version and clicking on the “About” button, pops-up the About dialog box showing more information on the software.

On-line help may be accessed at any time during the software’s use by pressing F1 on the keyboard.

It is also possible to quit the program by clicking on the close button .

If the ADM1022 is not found on the printer port, the following message will appear:-

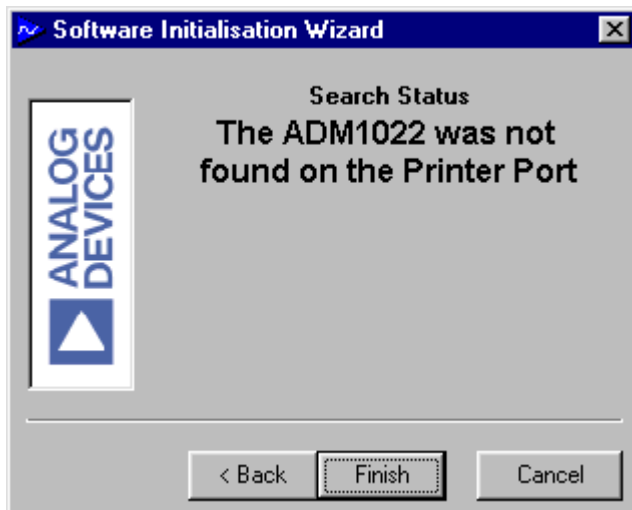

If the ADM1022 is not found on the SMBus, the following message will appear:-

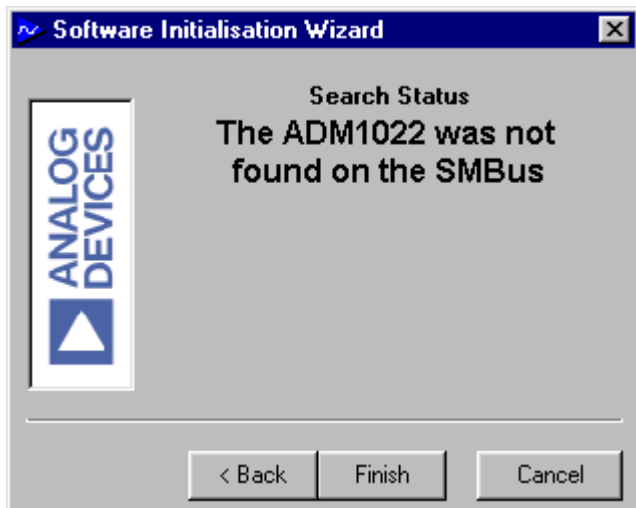

EVAL-ADM1022

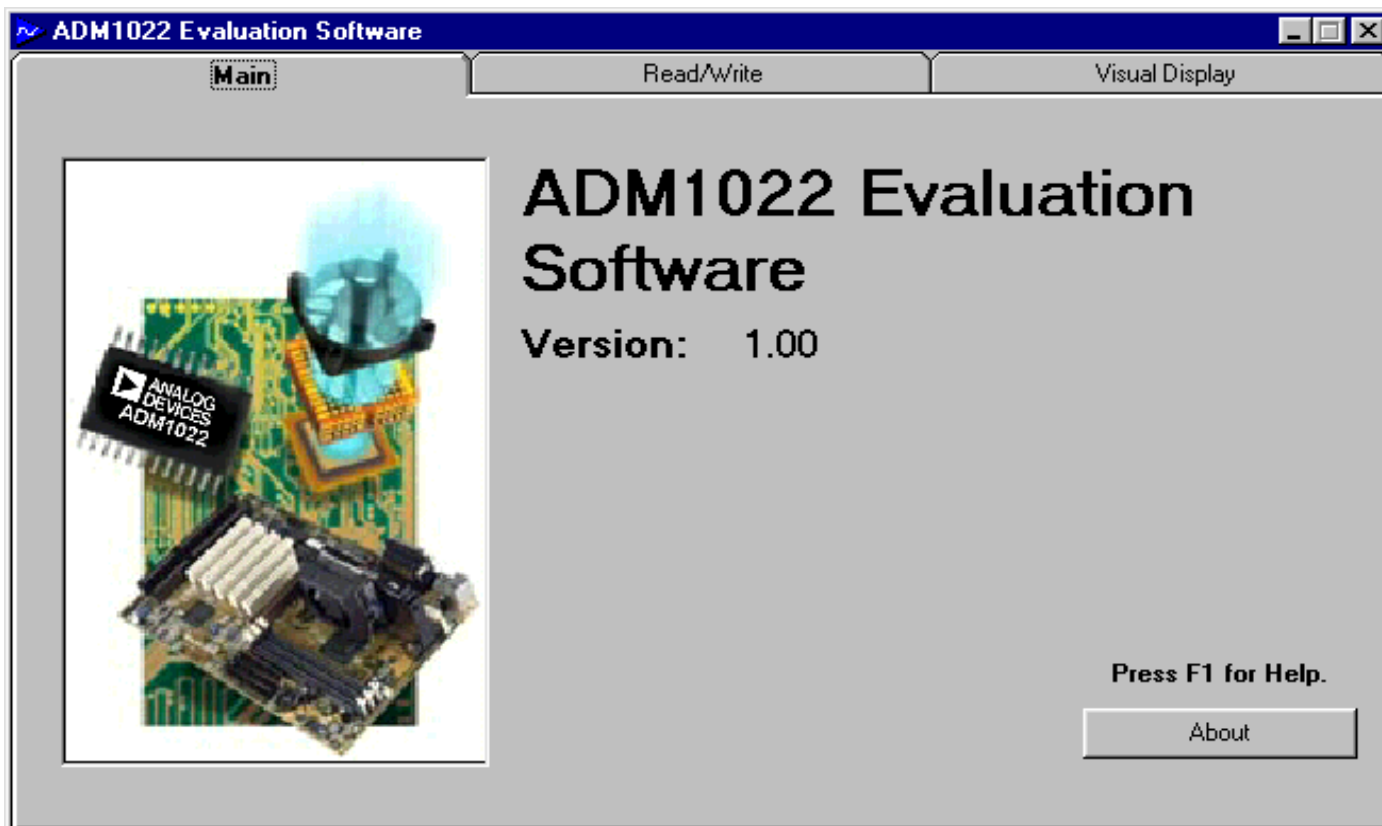

Figure 3. Main Program Tab

READ/WRITE

This tab displays information about the ADM1022's internal registers. It allows their contents to be read and/or altered. Each register has a label associated with it printed on the tab. Moving the mouse pointer over the label changes the register label colour to light green. When the register label is clicked, it becomes a highlighted yellow. Now this register will become the default on-screen register and the register label will turn dark green to indicate this.

The contents of the selected register will be displayed in the register contents box, along with the name of each individual register bit. The register contents are also displayed in hexadecimal and decimal format.

Clicking on a register label will cause its contents to be read once if continuous reading is off. If continuous reading is on, the register contents will be displayed continuously; allowing any register bit changes to be viewed immediately.

When a register label is clicked, it performs a single read of that register from the ADM1022. Therefore, continuous reading will be off:-



If however, the user wishes to continuously monitor the selected register, then this can be done by toggling the continuous reading button to its on-state.

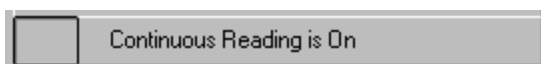

When a register label has been clicked, the Read/Write portion of the form reflects each individual bit of the selected register. Thus, any bit of the register may be modified or monitored in this box.

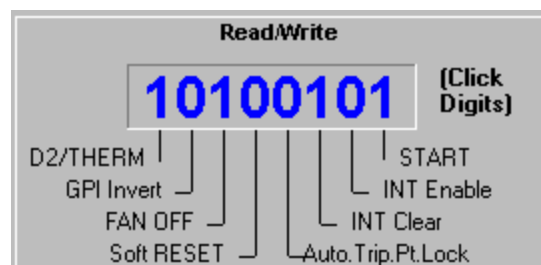

Alternatively, the entire contents of a register may be changed by typing a Hex or Decimal value in the “Write” text box. When the contents of the text box is altered, the button alongside will change from green to red, signifying a newly entered value. Clicking on the red button will write the updated value to the selected register.



This feature is useful where a register contains a numeric value, such as a temperature limit.

Another useful portion of the form provides info about the selected register; the address of the register, and the previous values read and written to/from the register.

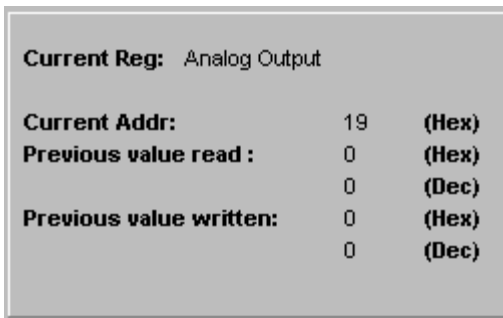

VISUAL DISPLAY

The Visual Display tab allows all three temperature measurement channels to be monitored and graphed.

EASY SETUP

At the bottom of the Visual Display Tab is the “Easy Setup” button:-

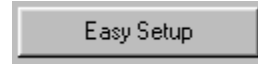

If the ADM1022 has been configured for only one remote thermal diode, then pressing “Easy Setup” will graph the Internal Temperature and the Remote Diode temperature.

If the ADM1022 has been configured for both remote thermal diode channels, then pressing the “Easy Setup” button will graph the Internal Temperature and the two Remote Diode temperature channels.

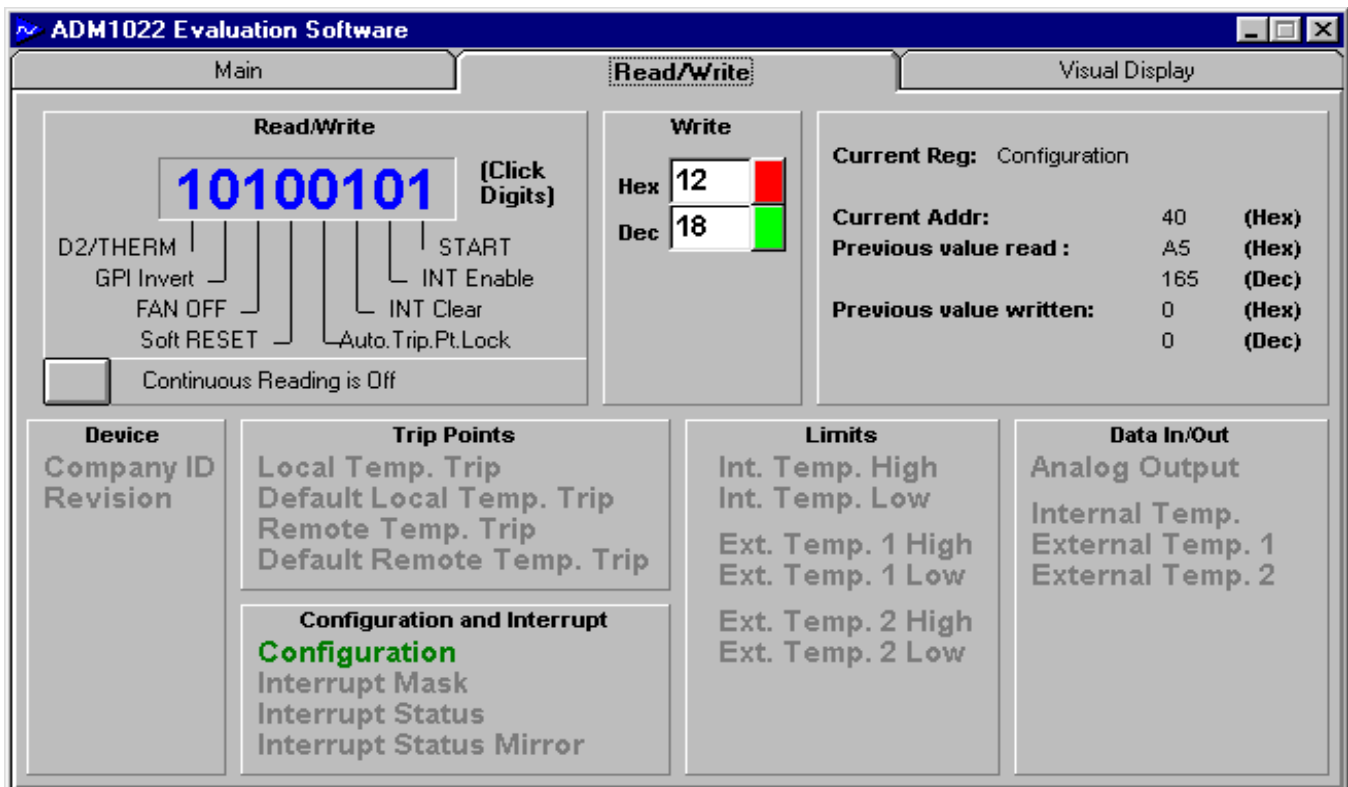
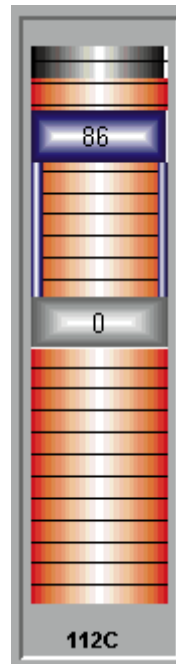
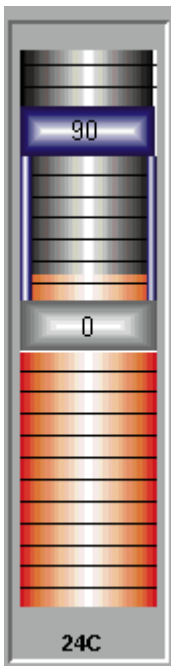

Figure 4. Read/Write Program Tab

EVAL-ADM1022

BARGRAPH

On the left-most position of the Visual Display tab is the bargraph control/indicator. This 3D-type indicator gives a visual indication of the selected temperature channel. The bargraph also has 2 moveable controls; these control the upper and lower interrupt limits which may be set for each temperature channel. Once the temperature moves outside these limits, an interrupt will be generated if the interrupt source is unmasked in the Interrupt Mask Register (please refer to the ADM1022 datasheet for more detailed interrupt information).



As shown above, when the temperature goes beyond a programmed temperature limit (86°C in this case), an interrupt is generated and the LED lights up for that channel. External 1 is the channel being displayed, since the label is green. The absolute temperature on that channel is 112°C, as shown at the base of the temperature bargraph.

Each temperature channel's limits may be adjusted independently of the next channel, by selecting the channel from the bargraph panel on the Visual Display tab. The channel may be selected by clicking on it, and will turn green to indicate its selection.

The temperature value is displayed below the bargraph, allowing absolute readings to be monitored. The bargraph gives a useful indication of whether temperature is rising or falling, and the rate at which it is doing so.

If the temperature goes outside the programmed limits, an error is generated for that channel, and the bargraph panel will give a visual indication of this.

FAN SPEED CONTROL

The ADM1022 can control the speed of a fan connected to it. This tab contains a slider control to manually adjust the default fan speed.

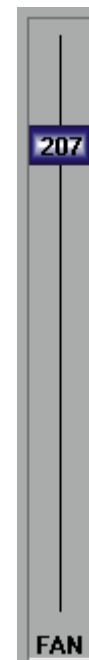

GRAPHING

On the right-most of the Visual Display tab is a line graph. Once the “Easy Setup” button is clicked, graphing begins. Each temperature channel is plotted against time. The graph contains a colour legend to associate each coloured line with each temperature channel.

While the display is graphing, the user can click on the Read/Write tab, and make any adjustments, without having to stop the graphing. This feature can be useful for enabling or disabling interrupts, or other functions, whilst still measuring temperature.

While the graph is displayed on the screen, it is possible to zoom in or out by moving the arrows on the temperature and time axes. Moving the lower arrow up the temperature axis, increases the minimum temperature shown on the graph, while moving the upper arrow down decreases the maximum temperature displayed. This effectively allows zooming in on a narrower temperature range. Similarly, moving the left arrow to the right on the time axis and/or the right arrow to the left, displays a narrower band of time on this axis.

The graph can be cleared at any time by pressing the “Easy Setup” button again. Note that doing so will cause all the registers to be re-initialised to their default values.

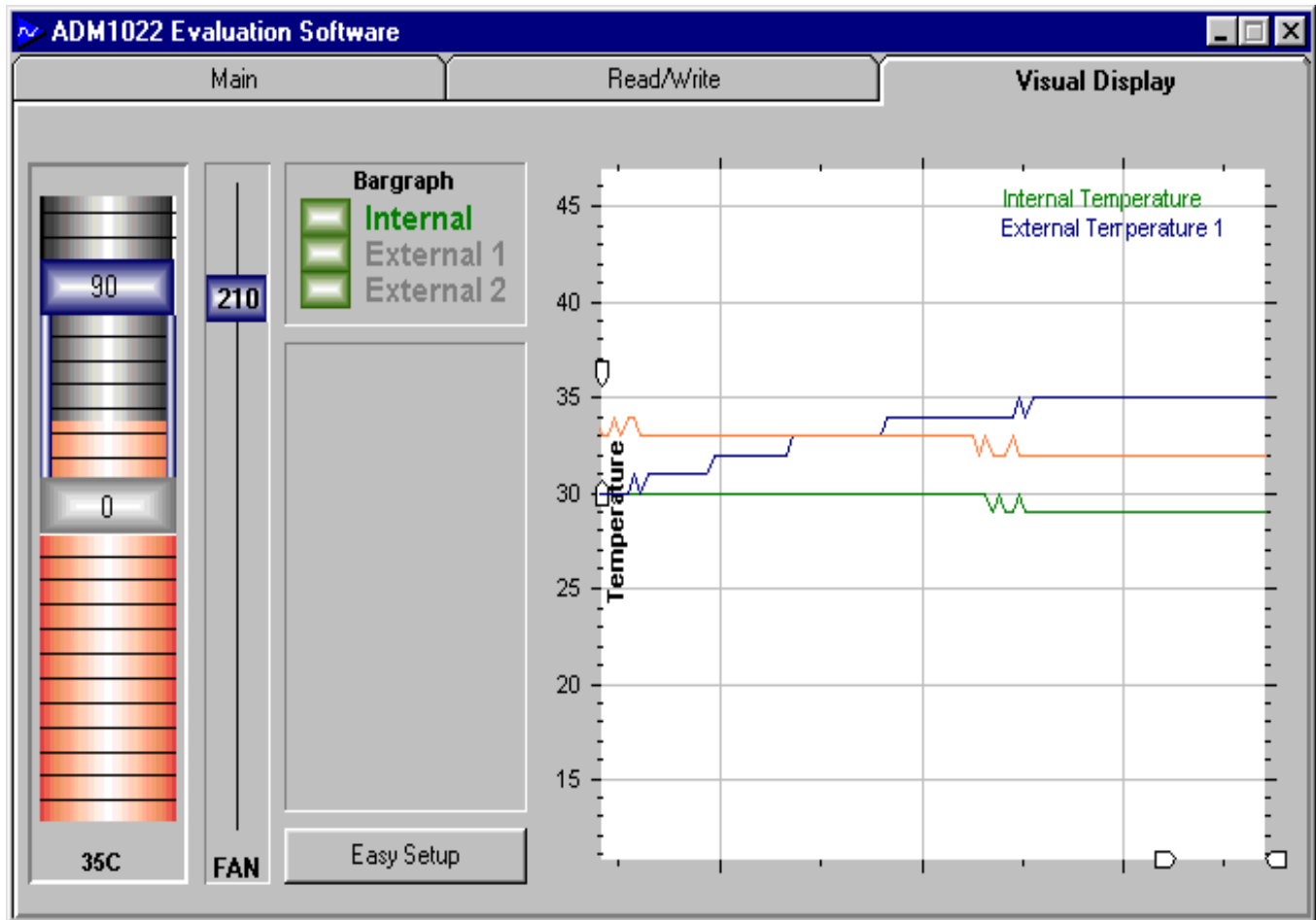

Figure 5. Visual Display tab

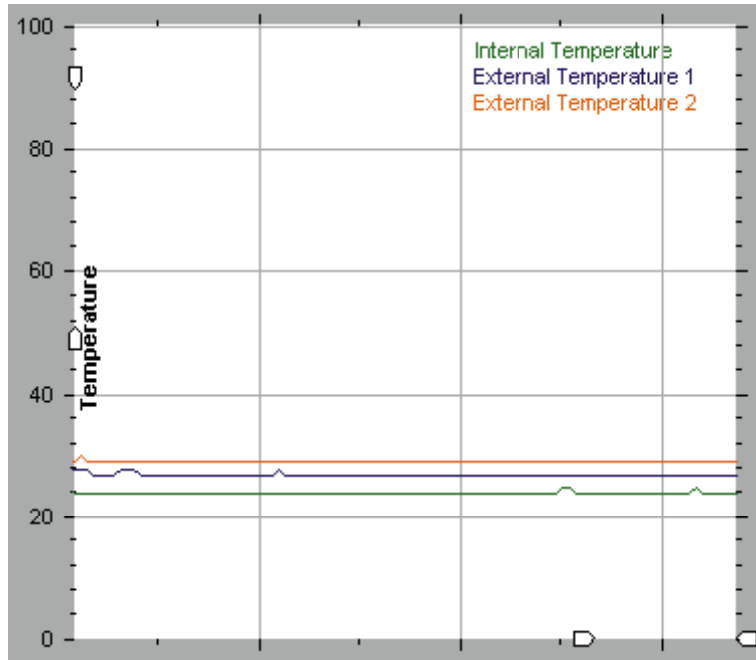

Figure 6. Normal Graph

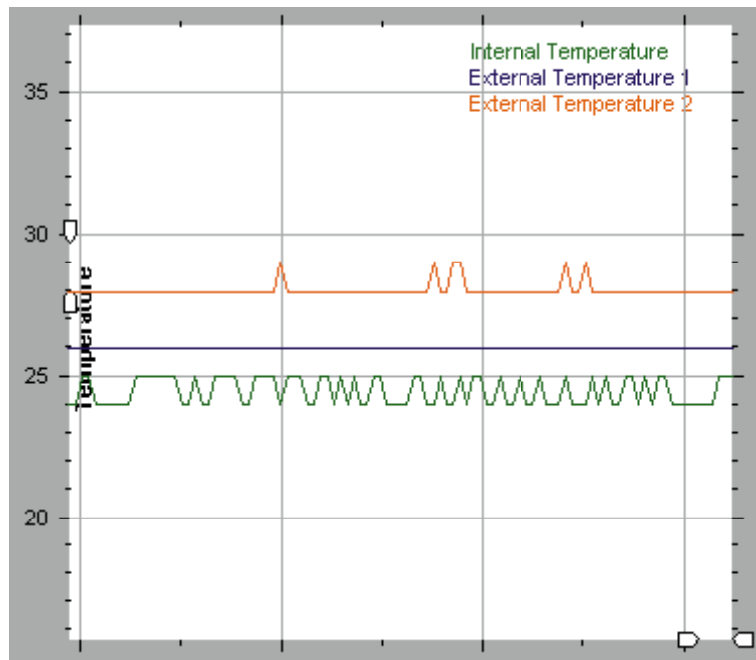

Fig 7. Zoomed In Graph

APPENDIX A. ADM1022 REGISTERS

More detailed information on each of the registers may be found in the ADM1022 datasheet.

TABLE 7. LIST OF ADM1022 REGISTERS

Register Name	Address A7 - A0 in hex	Comments
Value Registers	0x13 - 0x3A	See Table 8
Company ID	0x3E	This location will contain the company identification number. This register is read only.
Revision	0x3F	This location will contain the revision number of the part in the lower four bits of the register [3:0]. The upper four bits reflect the ADM1022 Version Number [7:4]. The first version is 1100. The next version of ADM1022 would be 1101, etc. For instance, if the stepping were A0 and this part is a ADM1022, then this register would read 1100 0000. This register is read only.
Configuration Register	0x40	Power on value = 0010 0101
Interrupt Status Register	0x41	Power on value = 0000 0000
Interrupt Mask Register	0x43	Power on value = 0000 0000
Interrupt Status Register Mirror	0x4C	Power on value = 0000 0000

TABLE 8. REGISTERS 0X13- 0X3A VALUE REGISTERS

Address	Read/Write	Description
0x13	Read/Write	Programmable Local Temp Sensor Automatic Trip Point - default 70 degrees C. This register can only be written to if the write once bit in the configuration register (0x40, bit 3) has not been set.
0x14	Read/Write	Programmable Remote Thermal Diode Automatic Trip Point - default 100 degrees C. This register can only be written to if the write once bit in the configuration register (0x40, bit 3) has not been set.
0x15	Read/Write	Test register for manufacturer's use only. Do not write to this register
0x17	Read Only	Default Local Temp Sensor Automatic Trip Point - default 70 degrees C Cannot be changed. Disabled when bit 3 of Config. register is set
0x18	Read Only	Default Remote Thermal Diode Automatic Trip Point - default 100 degrees C Cannot be changed. Disabled when bit 3 of Config register is set
0x19	Read/Write	Analog Output, FAN_SPD (defaults to 0x00h)
0x20	Read Only	External Temperature Value Diode 2
0x26	Read Only	External Temperature Value Diode 1
0x27	Read Only	Internal Temperature
0x2B	Read/Write	External Temperature Diode 2 High Limit
0x2C	Read/Write	External Temperature Diode 2 Low Limit
0x37	Read/Write	External Temperature Diode 1 High Limit
0x38	Read/Write	External Temperature Diode 1 Low Limit
0x39	Read/Write	Internal Temperature High Limit
0x3A	Read/Write	Internal Temperature Low Limit

EVAL-ADM1022

APPENDIX B. COMPONENT LIST

Capacitors

C1,C2,C3	10 μ F tantalum
C4,C5,C6	0.1 μ F

Resistors

R1	47k
R2,R4,R5,R15	10k
R3,R6,R7,R9,R14,R16	680R
R8	80R
R10,R11,R12,R13	2k2

Semiconductors

Q1,Q3	2N3904
Q2	2N3906
D1,D2,D4	Green LED
D3,D6,D7	Red LED
D5	1N4001
U1	ADM1022
U2	AD820
U4	74HC05
U6	78L033

Connectors

J1	Power socket
J2	36-way Centronics
J3	10-way R.A. IDC socket
J4	2mm 8-way test socket
J5,J6	Terminal post

Switches

SW1,SW2,SW3	3-way slide switch
SW4	DIL switch
PB1,PB2	pushbutton switch

Miscellaneous

U3	12V dc fan
----	------------