

**48Vin  
Input**

**18Vout  
Output**

**9.2Amp  
Current**

**2000Vdc  
Isolation**

**Half-brick  
DC/DC Converter**

The PQ60180HTA09 PowerQor™ Tera half-brick converter is a next-generation, board-mountable, isolated, fixed switching frequency DC/DC converter that uses synchronous rectification to achieve extremely high conversion efficiency. The power dissipated by the converter is so low that a heatsink is not required, which saves cost, weight, height, and application effort. The Tera series converters offer the maximum useable output current for a standard "half-brick" module. The Tera units also feature active current sharing for N+1 and parallel applications.

## PowerQor™ Tera



PQ60180HTA09 Module

### Operational Features

- Ultra-high efficiency, 92% at full rated load current
- Delivers up to 165 Watts of output power with minimal derating - no heatsink required
- Wide input voltage range: 35V – 75V, with 100V 100ms input voltage transient capability
- Fixed frequency switching provides predictable EMI performance

### Mechanical Features

- Industry standard half-brick pin-out configuration
- Industry standard size: 2.3" x 2.4" (58.4 x 61.0mm)
- Total height only 0.43" (11.2mm), permits better air-flow and smaller card pitch
- Total weight: 2.6 oz. (75 grams)

### Control Features

- On/Off control referenced to input side (positive and negative logic options are available)
- Remote sense for the output voltage compensates for output distribution drops
- Output voltage trim permits custom voltages and voltage margining

### Protection Features

- Input under-voltage lockout disables converter at low input voltage conditions
- Output current limit and short circuit protection
- Active back bias limit prevents damage to converter from external load induced pre-bias
- Output over-voltage protection
- Thermal shutdown

### Safety Features

- 2000V, 30 MΩ input-to-output isolation
- UL/cUL 60950 recognized (US & Canada), basic insulation rating
- TUV certified to EN60950
- Meets 72/23/EEC and 93/68/EEC directives
- Meets UL94V-0 flammability requirements

**Input:** 35-75 V  
**Output:** 18 V  
**Current:** 9.2 A (165W)  
**Package:** Half-brick

### MECHANICAL DIAGRAM

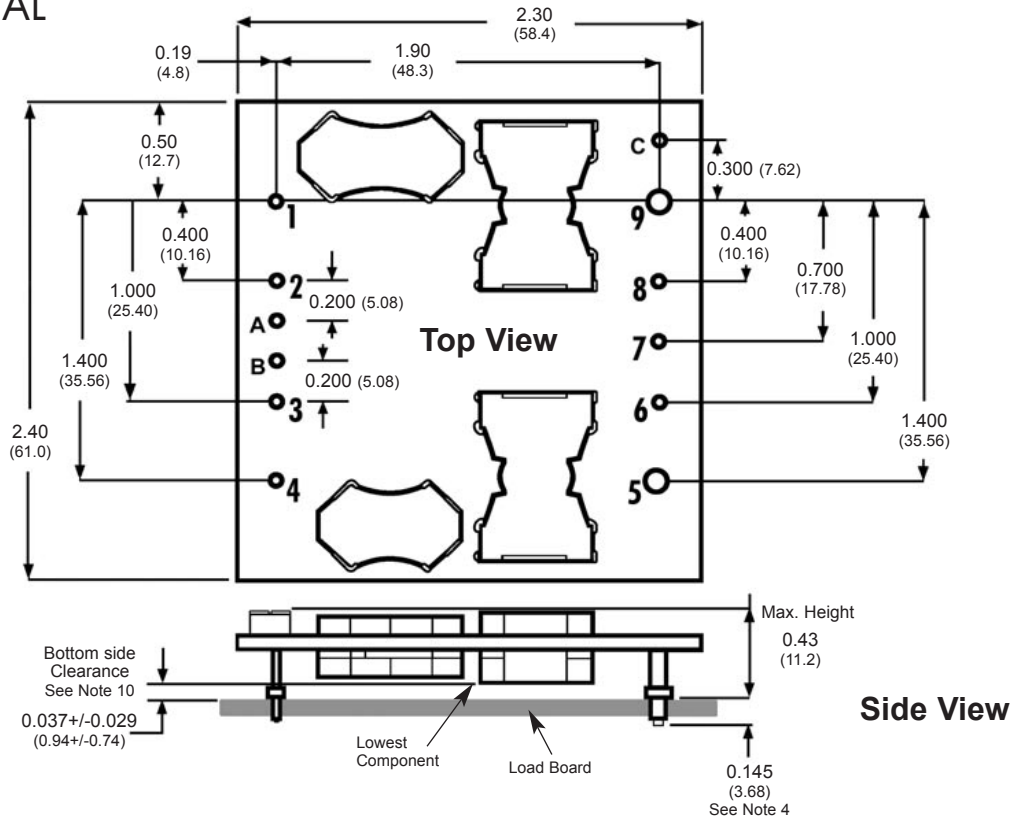

### NOTES

- 1) Pins 1-4, 6-8, A-C are 0.040" (1.02mm) diameter with 0.080" (2.03mm) diameter standoff shoulders.
- 2) Pins 5 and 9 are 0.080" (2.03 mm) diameter with 0.125" (3.18mm) diameter standoff shoulders.
- 3) Pins 3, A, B & C only included in Full-Feature models.
- 4) Other pin extension lengths available. Recommended pin length is 0.03" (0.76mm) greater than the PCB thickness.
- 5) All Pins: Material - Copper Alloy  
Finish - Tin/Lead over Nickel plate
- 6) Undimensioned components are shown for visual reference only.
- 7) All dimensions in inches (mm)  
Tolerances: x.xx +/-0.02 in. (x.x +/-0.5mm)  
x.xxx +/-0.010 in. (x.xx +/-0.25mm)
- 8) Weight: 2.6 oz. (75g) typical
- 9) Workmanship: Meets or exceeds IPC-A-610C Class II
- 10) UL/TUV standards require a clearance greater than 0.04" (1.02mm) between input and output for Basic insulation. This issue should be considered if any copper traces are on the top side of the user's board. Note that the ferrite cores are considered part of the input/primary circuit.

### PIN DESIGNATIONS

Pin No.	Name	Function
1	Vin(+)	Positive input voltage
2	ON/OFF	TTL input to turn converter on and off, referenced to Vin(-), with internal pull up.
3	<i>I share</i>	<i>Single wire parallel signal</i>
4	Vin(-)	Negative input voltage
5	Vout(-)	Negative output voltage
6	SENSE(-)	Return remote sense
7	TRIM	Output voltage trim
8	SENSE(+)	Positive remote sense
9	Vout(+)	Positive output voltage
A	<i>Clock Sync</i>	<i>Clock synchronization</i>
B	<i>Start Sync</i>	<i>Startup synchronization</i>
C	<i>OR Drive</i>	<i>External OR-FET drive</i>

*Pins in Italics Shaded text are not available on the 18Vout module*



# Technical Specification

**Input: 35-75 V**  
**Output: 18 V**  
**Current: 9.2 A (165W)**  
**Package: Half-brick**

## PQ60180HTA09 ELECTRICAL CHARACTERISTICS

T<sub>A</sub>=25°C, airflow rate=300 LFM, V<sub>in</sub>=48Vdc unless otherwise noted; full operating temperature range is -40°C to +100°C ambient temperature with appropriate power derating. Specifications subject to change without notice.

Parameter	Min.	Typ.	Max.	Units	Notes & Conditions
<b>ABSOLUTE MAXIMUM RATINGS</b>					
Input Voltage					
Non-Operating			100	V	continuous
Operating			80	V	continuous
Operating Transient Protection			100	V	100ms transient, square wave
Isolation Voltage (input to output)			2000	V	Basic insulation, Pollution degree 2
Operating Temperature	-40		100	°C	
Storage Temperature	-55		125	°C	
Voltage at ON/OFF input pin	-2		18	V	
Voltage at Clock Sync pin	-15		18	V	applies to Full Feature option only (N/A)
<b>INPUT CHARACTERISTICS</b>					
Operating Input Voltage Range	35	48	75	V	
Input Under-Voltage Lockout					
Turn-On Voltage Threshold	31.5	33.3	34.4	V	
Turn-Off Voltage Threshold	29.5	31.0	32.5	V	
Lockout Voltage Hysteresis	2.2	2.3	2.4	V	
Maximum Input Current			5.3	A	100% Load, 35 Vin
No-Load Input Current		90	105	mA	
Disabled Input Current		2	5	mA	
Inrush Current Transient Rating			0.03	A <sup>2</sup> s	
Response to Input Transient		1.3		V	1000V/ms input transient
Input Reflected Ripple Current		5		mA	RMS thru 10µH inductor; Figures 13 & 15
Input Terminal Ripple Current		145		mA	RMS; Figures 13 & 14
Recommended Input Fuse			20	A	fast blow external fuse recommended
Input Filter Component Values (C1\LC2)		2\4\4.1		µF\µH\µF	internal values, see Figure E
Recommended External Input Capacitance		47		µF	Typical ESR 0.1-0.2Ω, see Figure 13
<b>OUTPUT CHARACTERISTICS</b>					
Output Voltage Set Point	17.85	18.00	18.15	V	
Output Voltage Regulation					
Over Line		±0.05 \ 8	±0.1 \ 15	%\mV	
Over Load		±0.1 \ 15	±0.2 \ 30	%\mV	
Over Temperature		±45	±90	mV	
Total Output Voltage Range	17.715		18.285	V	over sample, line, load, temperature & life
Output Voltage Ripple and Noise <sup>1</sup>					20MHz bandwidth; Figures 13 & 16
Peak-to-Peak		50	100	mV	Full Load, see Figures 13 & 16
RMS		15	30	mV	Full Load, see Figures 13 & 16
Operating Output Current Range	0		9.2	A	Subject to thermal derating; Figures 5-8
Output DC Current-Limit Inception	10.1	11.0	11.9	A	Output Voltage 10% Low; Figure 17
Output DC Current-Limit Shutdown Voltage		12.5		V	
Current Share Accuracy (2 units paralleled)		±2	±5	%	% of rated output current
Back-Drive Current Limit while Enabled	0.1	0.4	0.7	A	Negative current drawn from output
Back-Drive Current Limit while Disabled	0	10	50	mA	Negative current drawn from output
Maximum Output Capacitance			3,000	µF	18Vout at 9.2A Resistive Load
<b>DYNAMIC CHARACTERISTICS</b>					
Input Voltage Ripple Rejection		70		dB	120 Hz; Figure 20
Output Voltage during Load Current Transient					
For a Step Change in Output Current (0.1A/µs)		700		mV	50% to 75% to 50% lout max; Figure 11
For a Step Change in Output Current (5A/µs)		700		mV	50% to 75% to 50% lout max; Figure 12
Settling Time		300		µs	to within 1% Vout nom
Turn-On Transient					
Turn-On Time		20	30	ms	Full load, Vout=90% nom.; Figures 9 & 10
Start-Up Inhibit Time	180	200	240	ms	-40°C to +125°C; Figure A
Output Voltage Overshoot		0		%	3,000 µF load capacitance, lout = 0A
<b>EFFICIENCY</b>					
100% Load		92		%	Figures 1 - 4
50% Load		92		%	Figures 1 - 4
<b>TEMPERATURE LIMITS FOR POWER DERATING CURVES</b>					
Semiconductor Junction Temperature			125	°C	Package rated to 150°C
Board Temperature			125	°C	UL rated max operating temp 130°C
Transformer Temperature			125	°C	See Figures 5 - 8 for derating curves
<b>ISOLATION CHARACTERISTICS</b>					
Isolation Voltage (dielectric strength)		2000		V	
Isolation Resistance		30		MΩ	
Isolation Capacitance <sup>2</sup>		3300		pF	

Note 1: For applications requiring reduced output voltage ripple and noise, consult SynQor applications support (e-mail: support@synqor.com)

Note 2: Higher values of isolation capacitance can be added external to the module.



# Technical Specification

**Input:** 35-75 V  
**Output:** 18 V  
**Current:** 9.2 A (165W)  
**Package:** Half-brick

## ELECTRICAL CHARACTERISTICS (Continued)

Parameter	Min.	Typ.	Max.	Units	Notes & Conditions
<b>FEATURE CHARACTERISTICS</b>					
Switching Frequency	205	230	255	kHz	Regulation stage and Isolation stage
ON/OFF Control (Option P)					
Off-State Voltage	-2		0.8	V	
On-State Voltage	2.7		18	V	
ON/OFF Control (Option N)					
Off-State Voltage	2.7		18	V	
On-State Voltage	-2		0.8	V	
ON/OFF Control (Either Option)					Figures A, B
Pull-Up Voltage		$V_{in}/6$	15	V	
Pull-Up Resistance		42		k $\Omega$	
Output Voltage Trim Range	-20		+10	%	Measured across Pins 9 & 5; Figure C
Output Voltage Remote Sense Range			+10	%	Measured across Pins 9 & 5
Output Over-Voltage Protection	117	122	127	%	Over full temp range; % of nominal Vout
Over-Temperature Shutdown		120		$^{\circ}$ C	Average PCB Temperature
Over-Temperature Shutdown Restart Hysteresis		10		$^{\circ}$ C	
Load Current Scale Factor		178			See App Note: Output Load Current Calc.
<b>RELIABILITY CHARACTERISTICS</b>					
Calculated MTBF (Telcordia)		2.2		10 <sup>6</sup> Hrs.	TR-NWT-000332; 80% load, 300LFM, 40 $^{\circ}$ C T <sub>a</sub>
Calculated MTBF (MIL-217)		1.3		10 <sup>6</sup> Hrs.	MIL-HDBK-217F; 80% load, 300LFM, 40 $^{\circ}$ C T <sub>a</sub>
Field Demonstrated MTBF				10 <sup>6</sup> Hrs.	See website for latest values

## STANDARDS COMPLIANCE

Parameter	Notes
<b>STANDARDS COMPLIANCE</b>	
UL/cUL 60950	File # E194341, Basic insulation & pollution degree 2
EN60950	Certified by TÜV
72/23/EEC	
93/68/EEC	
Needle Flame Test (IEC 695-2-2)	test on entire assembly; board & plastic components UL94V-0 compliant
IEC 61000-4-2	ESD test, 8kV - NP, 15kV air - NP (Normal Performance)
GR-1089-CORE	Section 7 - electrical safety, Section 9 - bonding/grounding
Telcordia (Bellcore) GR-513	

- An external input fuse must always be used to meet these safety requirements. Contact SynQor for official safety certificates on new releases or download from the SynQor website.

## QUALIFICATION TESTING

Parameter	# Units	Test Conditions
<b>QUALIFICATION TESTING</b>		
Life Test	32	95% rated V <sub>in</sub> and load, units at derating point, 1000 hours
Vibration	5	10-55Hz sweep, 0.060" total excursion, 1 min./sweep, 120 sweeps for 3 axis
Mechanical Shock	5	100g minimum, 2 drops in x and y axis, 1 drop in z axis
Temperature Cycling	10	-40 $^{\circ}$ C to 100 $^{\circ}$ C, unit temp. ramp 15 $^{\circ}$ C/min., 500 cycles
Power/Thermal Cycling	5	Toperating = min to max, V <sub>in</sub> = min to max, full load, 100 cycles
Design Marginality	5	T <sub>min</sub> -10 $^{\circ}$ C to T <sub>max</sub> +10 $^{\circ}$ C, 5 $^{\circ}$ C steps, V <sub>in</sub> = min to max, 0-105% load
Humidity	5	85 $^{\circ}$ C, 85% RH, 1000 hours, 2 minutes on and 6 hours off
Solderability	15 pins	MIL-STD-883, method 2003

- Extensive characterization testing of all SynQor products and manufacturing processes is performed to ensure that we supply robust, reliable product. Contact factory for official product family qualification document.

## OPTIONS

SynQor provides various options for Logic Sense, Pin Length and Feature Set for this family of DC/DC converters. Please consult the last page of this specification sheet for information on available options.

## PATENTS

SynQor is protected under various patents, including but not limited to U.S. Patent #s 5,999,417; 6,222,742 B1; 6,594,159 B2; 6,545,890 B2.

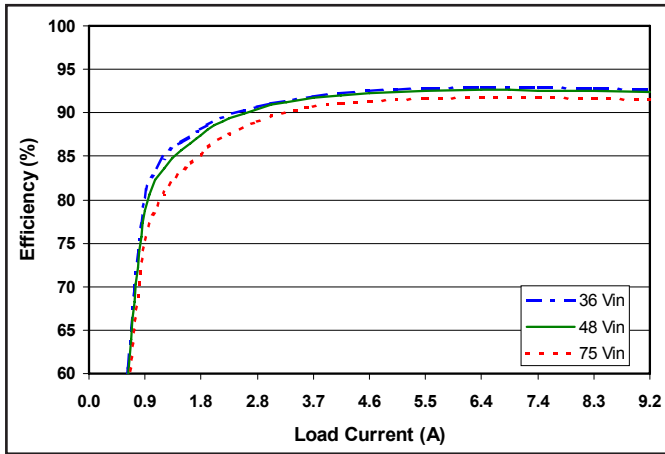

Figure 1: Efficiency at nominal output voltage vs. load current for minimum, nominal, and maximum input voltage at 25°C.

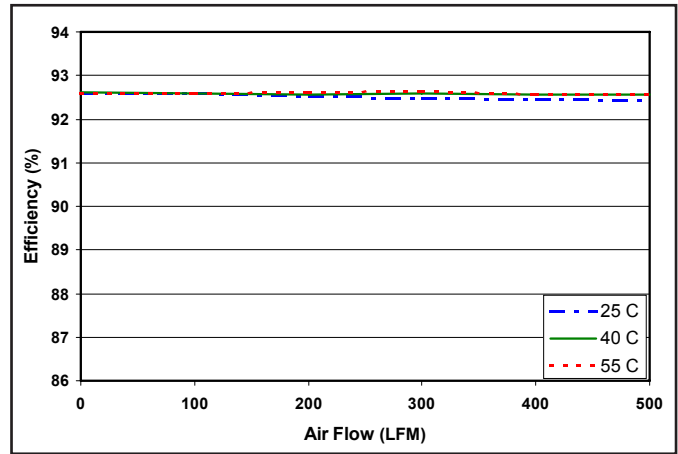

Figure 2: Efficiency at nominal output voltage and 60% rated power vs. airflow rate for ambient air temperatures of 25°C, 40°C, and 55°C (nominal input voltage).

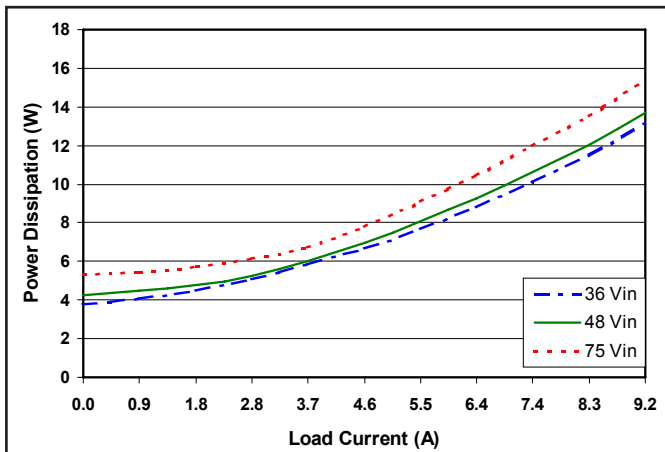

Figure 3: Power dissipation at nominal output voltage vs. load current for minimum, nominal, and maximum input voltage at 25°C.

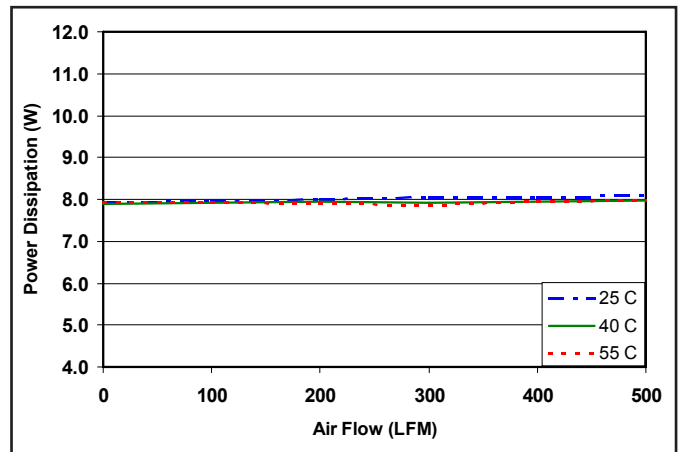

Figure 4: Power dissipation at nominal output voltage and 60% rated power vs. airflow rate for ambient air temperatures of 25°C, 40°C, and 55°C (nominal input voltage).

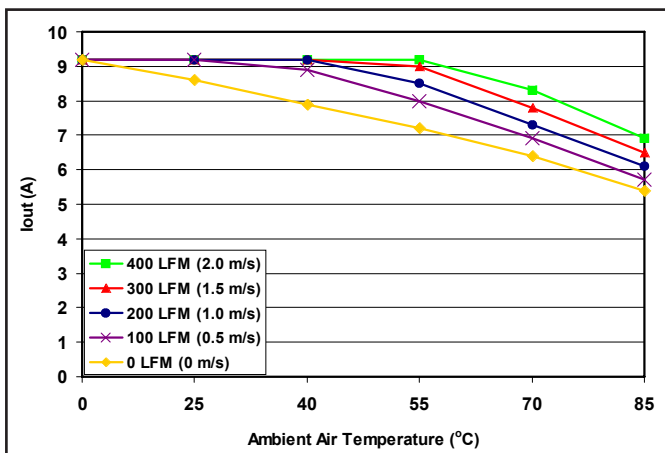

Figure 5: Maximum output power derating curves vs. ambient air temperature for airflow rates of 0 LFM through 400 LFM with air flowing from input to output (nominal input voltage).

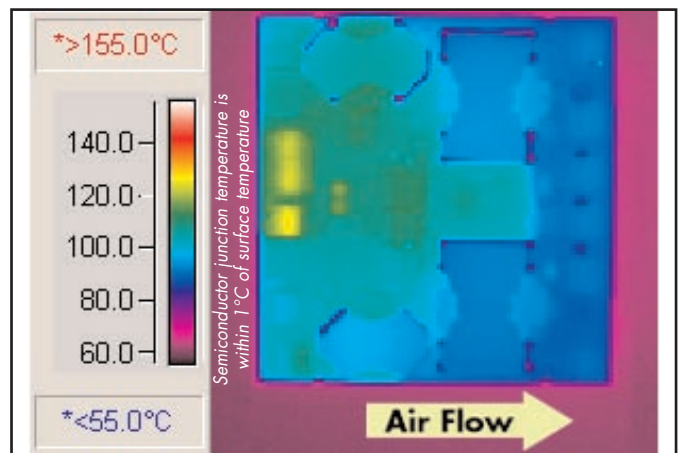

Figure 6: Thermal plot of converter at 8.5 amp load current (153W) with 55°C air flowing at the rate of 200 LFM. Air is flowing across the converter from input to output (nominal input voltage).

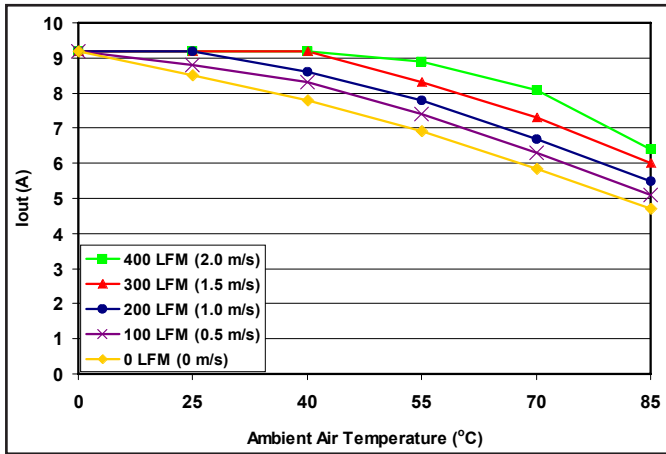

Figure 7: Maximum output power derating curves vs. ambient air temperature for airflow rates of 0 LFM through 400 LFM with air flowing from output to input (nominal input voltage).

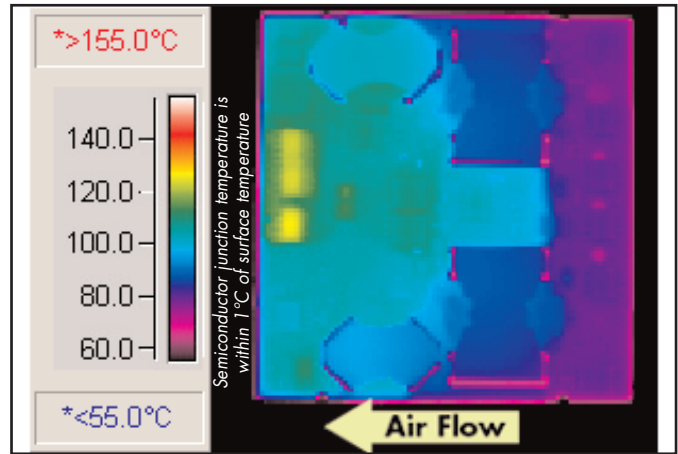

Figure 8: Thermal plot of converter at 7.8 amp load current (140W) with 55°C air flowing at the rate of 200 LFM. Air is flowing across the converter from output to input (nominal input voltage).

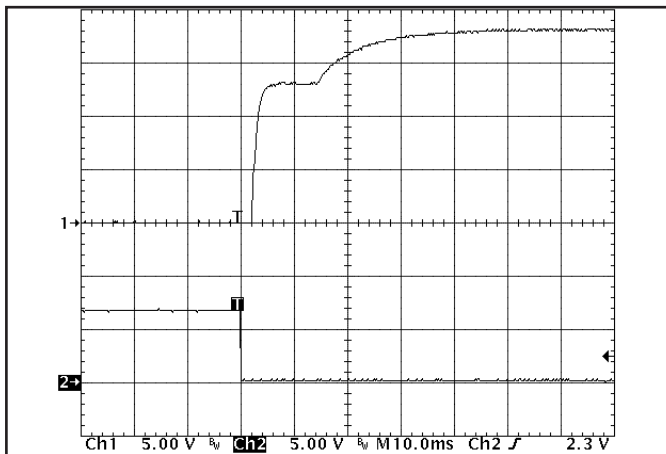

Figure 9: Turn-on transient at full load (resistive load) (10 ms/div). Input voltage pre-applied. Top Trace: V<sub>out</sub> (5V/div). Bottom Trace: ON/OFF input (5V/div)

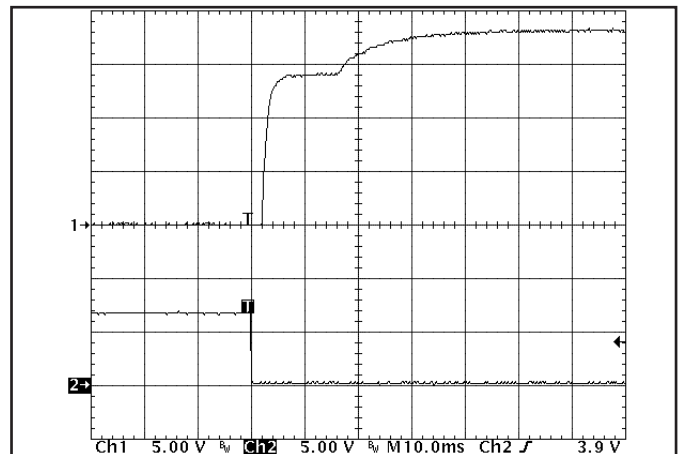

Figure 10: Turn-on transient at zero load (10 ms/div). Top Trace: V<sub>out</sub> (5V/div). Bottom Trace: ON/OFF input (5V/div).

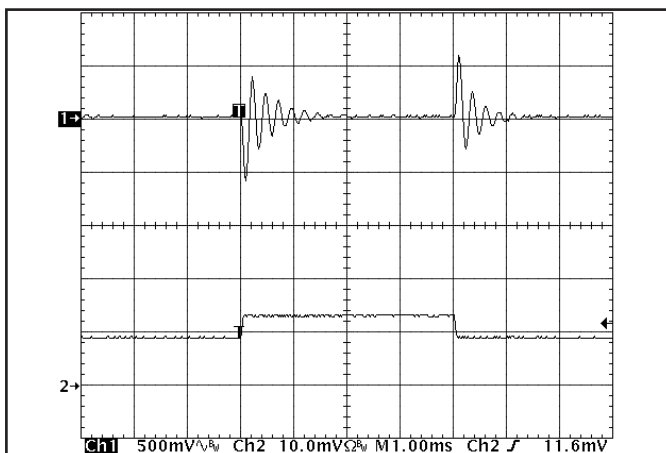

Figure 11: Output voltage response to step-change in load current (50%-75%-50% of I<sub>out</sub>(max); dI/dt = 0.1A/μs). Load cap: 15μF, 450 mΩ ESR tantalum cap and 1μF ceramic cap. Top trace: V<sub>out</sub> (500mV/div), Bottom trace: I<sub>out</sub> (5A/div).

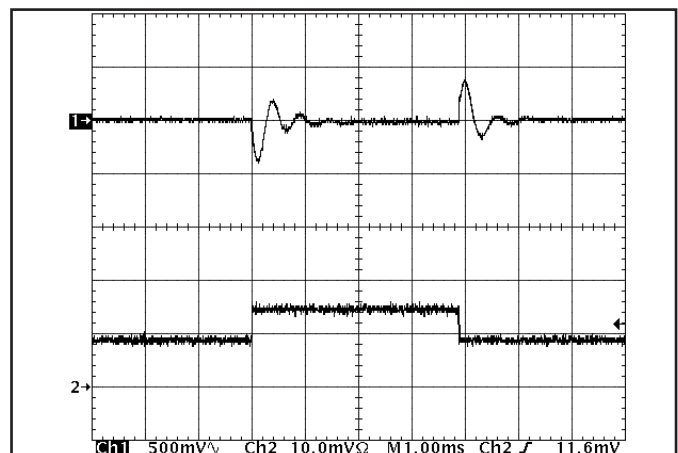
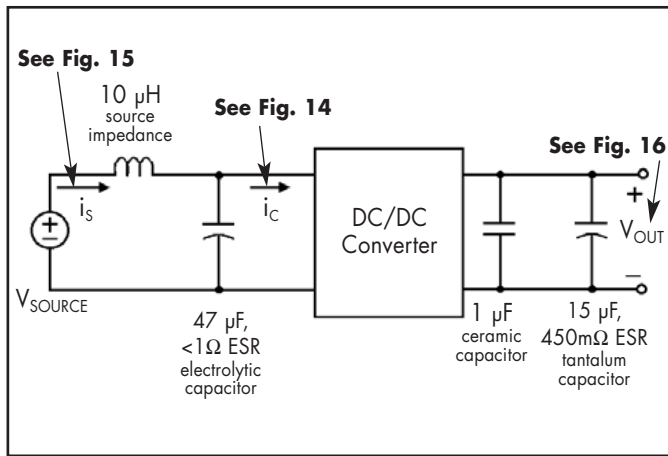
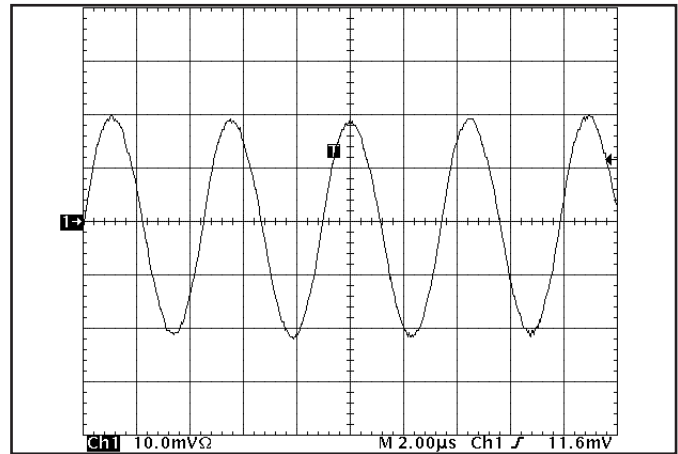

Figure 12: Output voltage response to step-change in load current (50%-75%-50% of I<sub>out</sub>(max); dI/dt = 5A/μs). Load cap: 480μF, 15 mΩ ESR tantalum cap and 1μF ceramic cap. Top trace: V<sub>out</sub> (500mV/div), Bottom trace: I<sub>out</sub> (5A/div).



**Figure 13:** Test set-up diagram showing measurement points for Input Terminal Ripple Current (Figure 14), Input Reflected Ripple Current (Figure 15) and Output Voltage Ripple (Figure 16).



**Figure 14:** Input Terminal Ripple Current,  $i_c$ , at full rated output current and nominal input voltage with  $10\ \mu\text{H}$  source impedance and  $47\ \mu\text{F}$  electrolytic capacitor ( $100\ \text{mA}/\text{div}$ ). (See Figure 13)

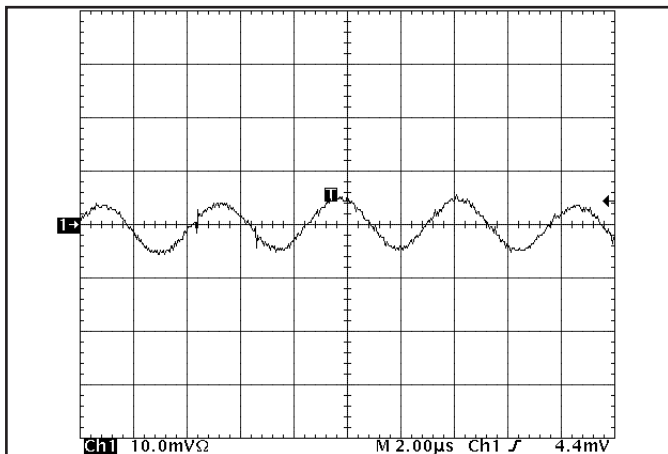

**Figure 15:** Input reflected ripple current,  $i_s$ , through a  $10\ \mu\text{H}$  source inductor at nominal input voltage and rated load current ( $5\ \text{mA}/\text{div}$ ). (See Figure 13)

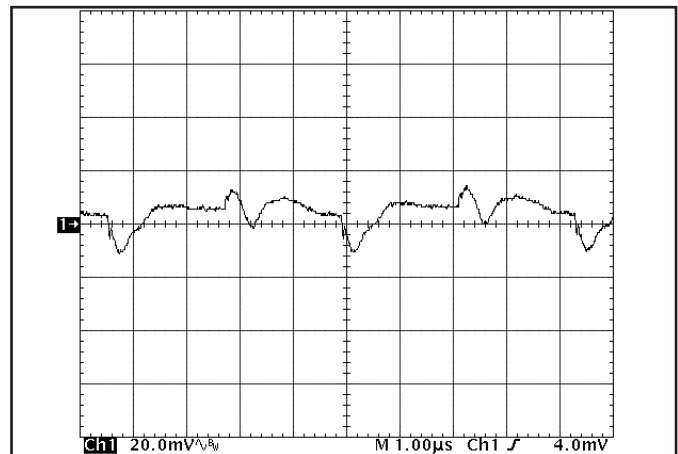

**Figure 16:** Output voltage ripple at nominal input voltage and rated load current ( $20\ \text{mV}/\text{div}$ ). Load capacitance:  $1\ \mu\text{F}$  ceramic capacitor and  $15\ \mu\text{F}$  tantalum capacitor. Bandwidth:  $20\ \text{MHz}$ . (See Figure 13)

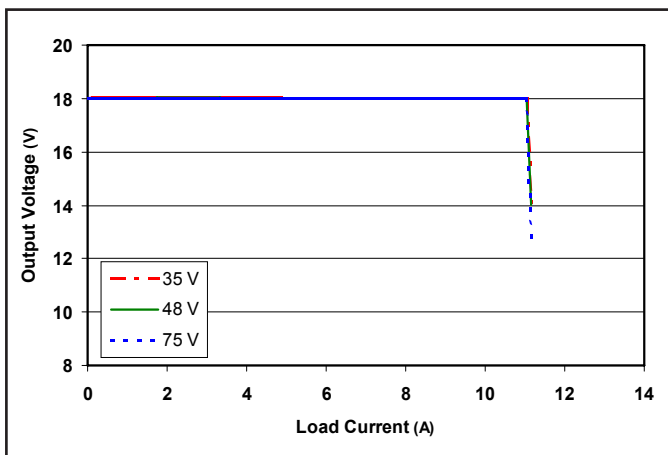

**Figure 17:** Output voltage vs. load current showing typical current limit curves and converter shutdown points.

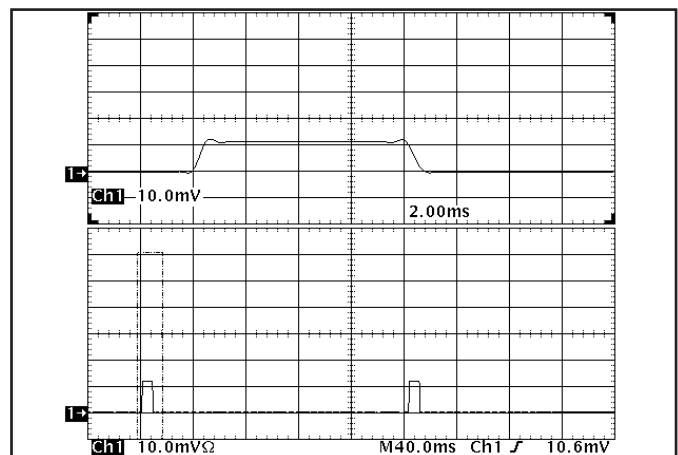

**Figure 18:** Load current ( $10\ \text{A}/\text{div}$ ) as a function of time when the converter attempts to turn on into a  $1\ \text{m}\Omega$  short circuit. Top trace ( $2\ \text{ms}/\text{div}$ ) is an expansion of the on-time portion of the bottom trace.

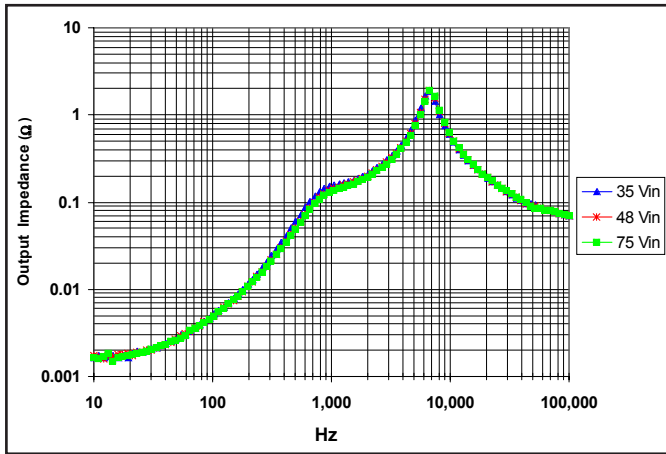

**Figure 19:** Magnitude of incremental output impedance ( $Z_{out} = v_{out}/i_{out}$ ) for minimum, nominal, and maximum input voltage at full rated power.

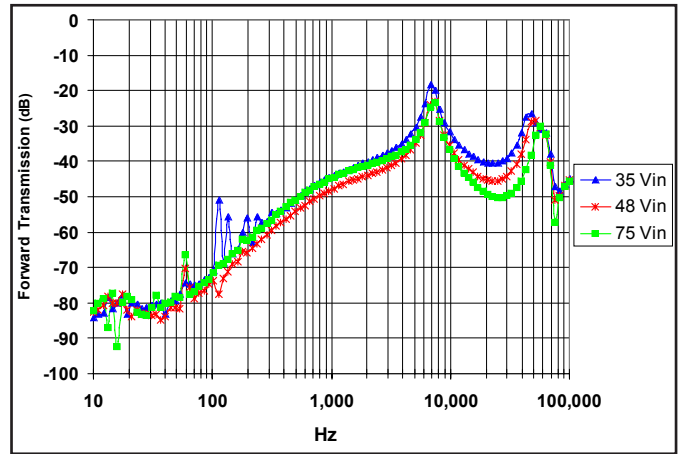

**Figure 20:** Magnitude of incremental forward transmission ( $FT = v_{out}/v_{in}$ ) for minimum, nominal, and maximum input voltage at full rated power.

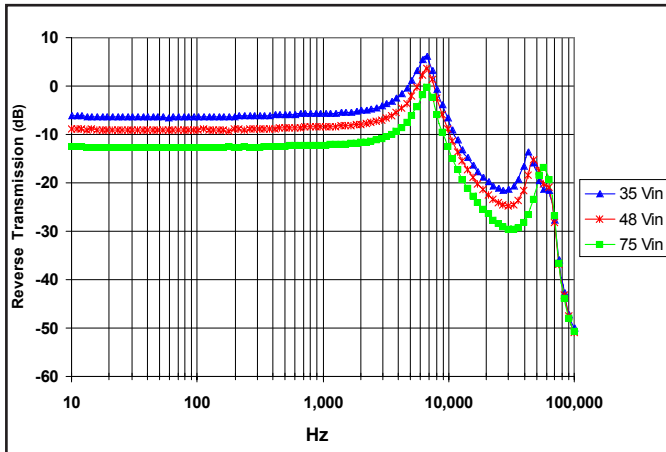

**Figure 21:** Magnitude of incremental reverse transmission ( $RT = i_{in}/i_{out}$ ) for minimum, nominal, and maximum input voltage at full rated power.

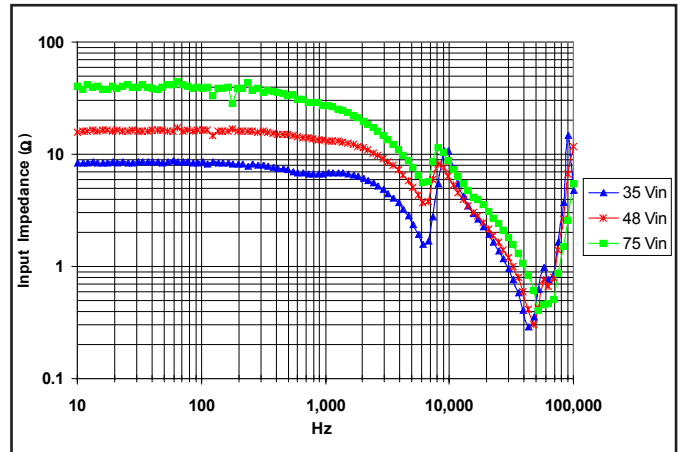

**Figure 22:** Magnitude of incremental input impedance ( $Z_{in} = v_{in}/i_{in}$ ) for minimum, nominal, and maximum input voltage at full rated power.



### BASIC OPERATION AND FEATURES

The PowerQor series converter uses a two-stage power conversion topology. The first stage is a buck-converter that keeps the output voltage constant over variations in line, load, and temperature. The second stage uses a transformer to provide the functions of input/output isolation and voltage step-down to achieve the low output voltage required.

Both the first stage and the second stage switch at a fixed frequency for predictable EMI performance. Rectification of the transformer's output is accomplished with synchronous rectifiers. These devices, which are MOSFETs with a very low on-state resistance, dissipate far less energy than Schottky diodes. This is the primary reason that the PowerQor converter has such high efficiency, even at very low output voltages and very high output currents.

Dissipation throughout the converter is so low that it does not require a heatsink for operation. Since a heatsink is not required, the PowerQor converter does not need a metal baseplate or potting material to help conduct the dissipated energy to the heatsink. The PowerQor converter can thus be built more simply and reliably using high yield surface mount techniques on a PCB substrate.

The PowerQor series of half-brick, quarter-brick and eighth-brick converters uses the industry standard footprint and pin-out configuration.

### CONTROL FEATURES

**REMOTE ON/OFF (Pin 2):** The ON/OFF input, Pin 2, permits the user to control when the converter is on or off. This input is referenced to the return terminal of the input bus, Vin(-). There are two versions of the converter that differ by the sense of the logic used for the ON/OFF input.

In the positive logic version, the ON/OFF input is active high (meaning that a high turns the converter on). In the negative logic version, the ON/OFF signal is active low (meaning that a low turns the converter on). Figure A details five possible circuits for driving the ON/OFF pin. Figure B is a detailed look of the internal ON/OFF circuitry.

**REMOTE SENSE(+)** (Pins 8 and 6): The SENSE(±) inputs correct for voltage drops along the conductors that connect the converter's output pins to the load.

Pin 8 should be connected to Vout(+) and Pin 6 should be connected to Vout(-) at the point on the board where regulation is desired. A remote connection at the load can adjust for a voltage drop only as large as that specified in this datasheet, that is

$$[V_{out(+)} - V_{out(-)}] - [V_{sense(+)} - V_{sense(-)}] \leq \text{Sense Range \%} \times V_{out}$$

Pins 8 and 6 must be connected for proper regulation of the output voltage. If these connections are not made, the converter will deliver an output voltage that is slightly lower than its specified value.

Note: the output over-voltage protection circuit senses the voltage

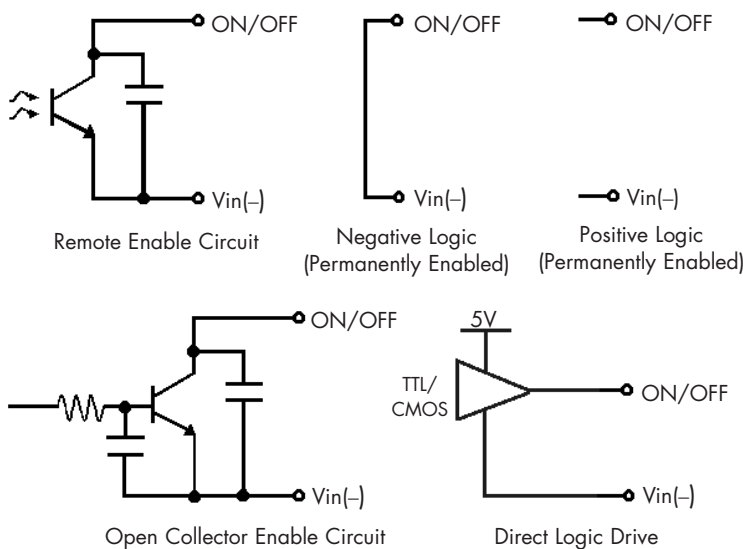

Figure A: Various circuits for driving the ON/OFF pin.

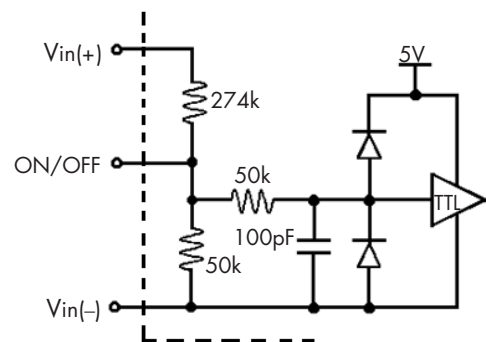

Figure B: Internal ON/OFF pin circuitry

across the output (pins 9 and 5) to determine when it should trigger, not the voltage across the converter's sense leads (pins 8 and 6). Therefore, the resistive drop on the board should be small enough so that output OVP does not trigger, even during load transients.

**OUTPUT VOLTAGE TRIM (Pin 7):** The TRIM input permits the user to adjust the output voltage across the sense leads up or down according to the trim range specifications.

To decrease the output voltage, the user should connect a resistor between Pin 7 and Pin 6 (SENSE(-) input). For a desired decrease of the nominal output voltage, the value of the resistor should be

$$R_{\text{trim-down}} = \left( \frac{100\%}{\Delta} \right) - 2 \text{ (k}\Omega\text{)}$$

where

$$\Delta\% = \left| \frac{V_{\text{nominal}} - V_{\text{desired}}}{V_{\text{nominal}}} \right| \times 100\%$$

To increase the output voltage, the user should connect a resistor between Pin 7 and Pin 8 (SENSE(+) input). For a desired increase of the nominal output voltage, the value of the resistor should be

$$R_{\text{trim-up}} = \frac{\left( \frac{V_{\text{nominal}}}{1.225} - 2 \right) \times V_{\text{DES}} + V_{\text{NOM}}}{V_{\text{DES}} - V_{\text{NOM}}} \text{ (k}\Omega\text{)}$$

Figure C graphs the relationship between the trim resistor value and  $R_{\text{trim-up}}$  and  $R_{\text{trim-down}}$ , showing the total range the output voltage can be trimmed up or down.

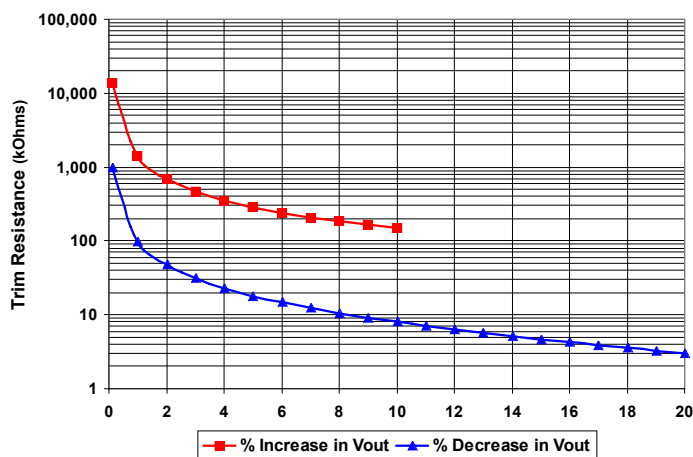

Figure C: Trim Graph for 18Vout module

**Note:** the TRIM feature does not affect the voltage at which the output over-voltage protection circuit is triggered. Trimming the

output voltage too high may cause the over-voltage protection circuit to engage, particularly during transients.

It is not necessary for the user to add capacitance at the Trim pin. The node is internally bypassed to eliminate noise.

**Total DC Variation of Vout:** For the converter to meet its full specifications, the maximum variation of the DC value of Vout, due to both trimming and remote load voltage drops, should not be greater than that specified for the output voltage trim range.

## PROTECTION FEATURES

**Input Under-Voltage Lockout:** The converter is designed to turn off when the input voltage is too low, helping avoid an input system instability problem, described in more detail in the application note titled "Input System Instability". The lockout circuitry is a comparator with DC hysteresis. When the input voltage is rising, it must exceed the typical Turn-On Voltage Threshold value (listed on the specification page) before the converter will turn on. Once the converter is on, the input voltage must fall below the typical Turn-Off Voltage Threshold value before the converter will turn off.

**Input Over-Voltage Shutdown:** Available on PQ48 models only. The converter turns off when the input voltage is too high, allowing the converter to withstand an input voltage as high as 100V without destruction. The shutdown circuitry is a comparator with DC hysteresis. When the input voltage exceeds the typical Input Over-Voltage Shutdown value, the converter will turn off. Once the converter is off, it will turn back on when the input voltage falls below the minimum Input Over-Voltage Shutdown value.

**Output Current Limit:** The maximum current limit remains constant as the output voltage drops. However, once the impedance of the short across the output is small enough to make the output voltage drop below the specified Output DC Current-Limit Shutdown Voltage, the converter turns off.

The converter then enters a "hiccup mode" where it repeatedly turns on and off at a 5 Hz (nominal) frequency with a 5% duty cycle until the short circuit condition is removed. This prevents excessive heating of the converter or the load board.

**Output Over-Voltage Limit:** If the voltage across the output pins exceeds the Output Over-Voltage Protection threshold, the converter will immediately stop switching. This prevents damage to the load circuit due to 1) excessive series resistance in output current path from converter output pins to sense point, 2) a release of a short-circuit condition, or 3) a release of a current limit condition. Load capacitance determines exactly how high the output voltage will rise in response to these conditions. After

200 ms the converter will automatically restart.

**Over-Temperature Shutdown:** A temperature sensor on the converter senses the average temperature of the module. The thermal shutdown circuit is designed to turn the converter off when the temperature at the sensed location reaches the Over-Temperature Shutdown value. It will allow the converter to turn on again when the temperature of the sensed location falls by the amount of the Over-Temperature Shutdown Restart Hysteresis value.

provides a diagram showing the internal input filter components. This filter dramatically reduces input terminal ripple current, which otherwise could exceed the rating of an external electrolytic input capacitor. The recommended external input capacitance is specified in the "Input Characteristics" section. More detailed information is available in the application note titled "EMI Characteristics" on the SynQor website.

## APPLICATION CONSIDERATIONS

**Input System Instability:** This condition can occur because any DC/DC converter appears incrementally as a negative resistance load. A detailed application note titled "Input System Instability" is available on the SynQor web site ([www.synqor.com](http://www.synqor.com)) which provides an understanding of why this instability arises, and shows the preferred solution for correcting it.

**Application Circuits:** Figure D below provides a typical circuit diagram which details the input filtering and voltage trimming.

**Input Filtering and External Capacitance:** Figure E below

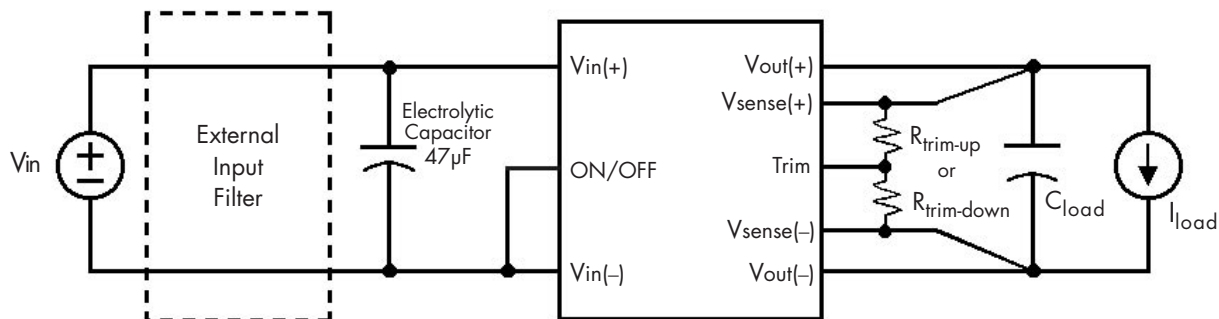

Figure D: Typical application circuit (negative logic unit, permanently enabled).

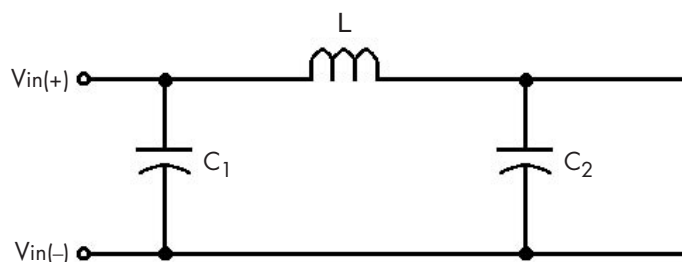

Figure E: Internal Input Filter Diagram (component values listed on page 3).

**Startup Inhibit Period:** The Startup Inhibit Period ensures that the converter will remain off for approximately 200ms when it is shut down for any reason. When an output short is present, this generates a 5Hz "hiccup mode," which prevents the converter from overheating. In all, there are seven ways that the converter can be shut down, initiating a Startup Inhibit Period:

- Input Under-Voltage Lockout
- Input Over-Voltage Shutdown (not present in Quarter-brick)
- Output Over-Voltage Protection
- Over Temperature Shutdown
- Current Limit
- Short Circuit Protection
- Turned off by the ON/OFF input

Figure F shows three turn-on scenarios, where a Startup Inhibit Period is initiated at  $t_0$ ,  $t_1$ , and  $t_2$ :

Before time  $t_0$ , when the input voltage is below the UVL threshold, the unit is disabled by the Input Under-Voltage Lockout feature. When the input voltage rises above the UVL threshold, the Input Under-Voltage Lockout is released, and a Startup Inhibit Period is initiated. At the end of this delay, the ON/OFF pin is evaluated, and since it is active, the unit turns on.

At time  $t_1$ , the unit is disabled by the ON/OFF pin, and it cannot be enabled again until the Startup Inhibit Period has elapsed.

When the ON/OFF pin goes high after  $t_2$ , the Startup Inhibit Period has elapsed, and the output turns on within the typical Turn-On Time.

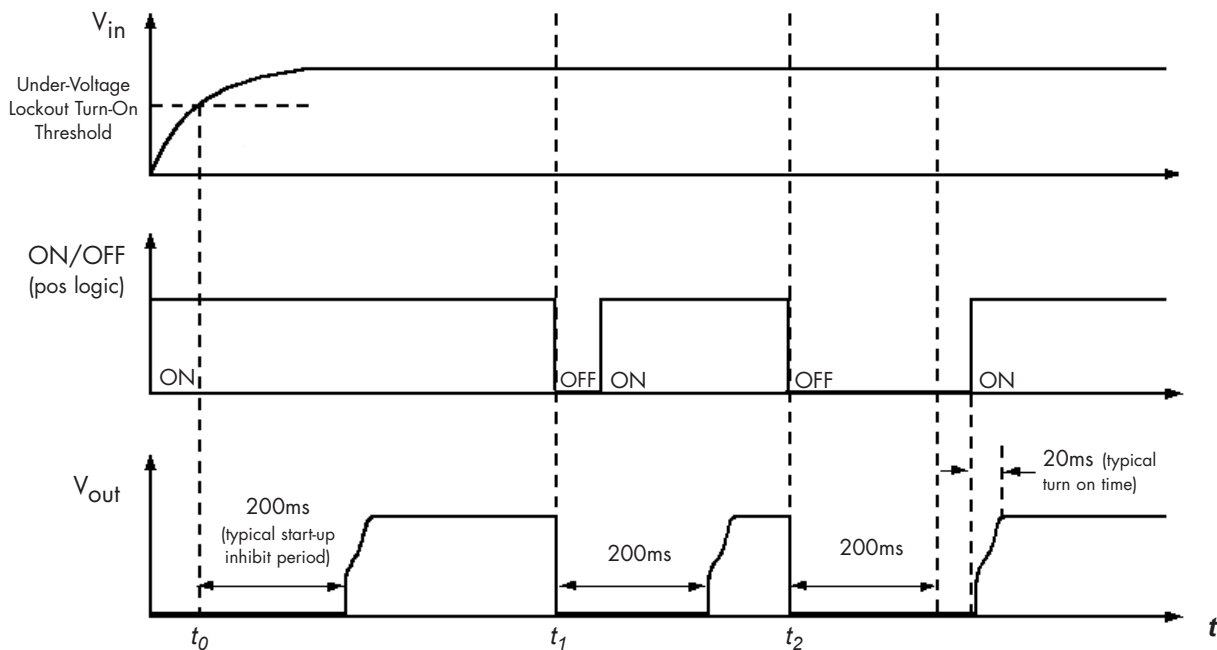

Figure F: Startup Inhibit Period (turn-on time not to scale)



# Technical Specification

**Input:** 35-75 V  
**Output:** 18 V  
**Current:** 9.2 A (165W)  
**Package:** Half-brick

## PART NUMBERING SYSTEM

The part numbering system for SynQor's PowerQor DC/DC converters follows the format shown in the example below.

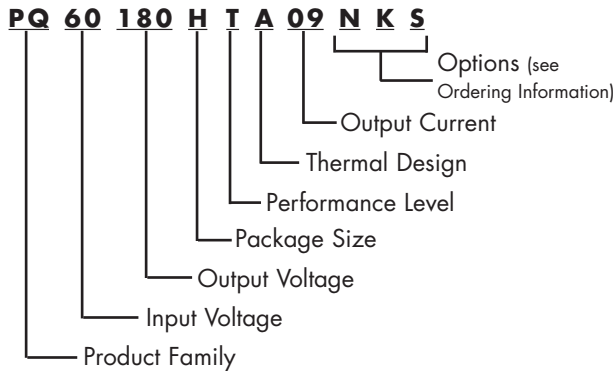

The first 12 characters comprise the base part number and the last 3 characters indicate available options. Although there are no default values for enable logic and pin length, the most common options are negative logic and 0.145" pins. These part numbers are more likely to be readily available in stock for evaluation and prototype quantities.

## Application Notes

A variety of application notes and technical white papers can be downloaded in pdf format at [www.synqor.com](http://www.synqor.com).

### Contact SynQor for further information:

**Phone:** 978-849-0600  
**Toll Free:** 888-567-9596  
**Fax:** 978-849-0602  
**E-mail:** [sales@synqor.com](mailto:sales@synqor.com)  
**Web:** [www.synqor.com](http://www.synqor.com)  
**Address:** 155 Swanson Road  
 Boxborough, MA 01719

## ORDERING INFORMATION

The tables below show the valid model numbers and ordering options for converters in this product family. When ordering SynQor converters, please ensure that you use the complete 15 character part number consisting of the 12 character base part number and the additional 3 characters for options. *PQ60 versions of the modules below indicate a unit with 100V for 100ms input voltage transient withstand (Telcordia GR-513).*

Model Number	Input Voltage	Output Voltage	Max Output Current
PQ60012HTA60xyz	35 - 75 V	1.2 V	60 A
PQ48015HTA60xyz	35 - 75 V	1.5 V	60 A
PQ48018HTA60xyz	35 - 75 V	1.8 V	60 A
PQ48020HTA60xyz	35 - 75 V	2.0 V	60 A
PQ48025HTA60xyz	35 - 75 V	2.5 V	60 A
PQ48033HTA50xyz	35 - 75 V	3.3 V	50 A
PQ48050HTA33xyz	35 - 75 V	5.0 V	33 A
PQ48120HTA14xyz	35 - 75 V	12 V	13.75 A
PQ48150HTA11xyz	35 - 75 V	15 V	11 A
PQ60180HTA09xyS	35 - 75 V	18 V	9.2 A
PQ60260HTB10xyz	35 - 75 V	26 V	9.6 A
PQ60525HTB04xyz	35 - 75 V	52.5 V	3.8 A

The following option choices must be included in place of the x y z spaces in the model numbers listed above. Full Feature option not available on the 18Vout module.

Options Description: x y z		
Enable Logic	Pin Length	Feature Set
P - Positive N - Negative	K - 0.110" N - 0.145" R - 0.180" Y - 0.250"	S - Standard F - Full Feature

### Warranty

SynQor offers a three (3) year limited warranty. Complete warranty information is listed on our web site or is available upon request from SynQor.

Information furnished by SynQor is believed to be accurate and reliable. However, no responsibility is assumed by SynQor for its use, nor for any infringements of patents or other rights of third parties which may result from its use. No license is granted by implication or otherwise under any patent or patent rights of SynQor.