

## Silicon PN Photodiode

### Description

BPW21R is a planar Silicon PN photodiode in a hermetically sealed short TO-5 case, especially designed for high precision linear applications.

Due to its extremely high dark resistance, the short circuit photocurrent is linear over seven decades of illumination level.

On the other hand, there is a strictly logarithmic correlation between open circuit voltage and illumination over the same range.

The device is equipped with a flat glass window with built in color correction filter, giving an approximation to the spectral response of the human eye.

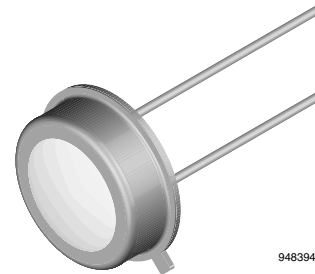

### Features

- Hermetically sealed TO-5 case
- Flat glass window with built-in color correction filter for visible radiation
- Cathode connected to case
- Wide viewing angle  $\varphi = \pm 50^\circ$
- Large radiant sensitive area ( $A = 7.5 \text{ mm}^2$ )
- Suitable for visible radiation
- High sensitivity
- Low dark current
- High shunt resistance
- Excellent linearity
- For photodiode and photovoltaic cell operation
- Lead (Pb)-free component
- Component in accordance to RoHS 2002/95/EC and WEEE 2002/96/EC



### Applications

- Sensor in exposure and color measuring purposes

### Absolute Maximum Ratings

$T_{\text{amb}} = 25^\circ\text{C}$ , unless otherwise specified

| Parameter                               | Test condition                         | Symbol            | Value         | Unit             |
|---|--|-------------------|---------------|------------------|
| Reverse Voltage                         |  | $V_R$             | 10            | V                |
| Power Dissipation                       | $T_{\text{amb}} \leq 50^\circ\text{C}$ | $P_V$             | 300           | mW               |
| Junction Temperature                    |  | $T_j$             | 125           | $^\circ\text{C}$ |
| Operating Temperature Range             |  | $T_{\text{amb}}$  | - 55 to + 125 | $^\circ\text{C}$ |
| Storage Temperature Range               |  | $T_{\text{stg}}$  | - 55 to + 125 | $^\circ\text{C}$ |
| Soldering Temperature                   | $t \leq 5 \text{ s}$                   | $T_{\text{sd}}$   | 260           | $^\circ\text{C}$ |
| Thermal Resistance Junction/<br>Ambient |  | $R_{\text{thJA}}$ | 250           | K/W              |

### Electrical Characteristics

$T_{amb} = 25\text{ }^{\circ}\text{C}$ , unless otherwise specified

| Parameter            | Test condition                                    | Symbol     | Min | Typ. | Max | Unit      |
|----------------------|---|------------|-----|------|-----|-----------|
| Forward Voltage      | $I_F = 50\text{ mA}$                              | $V_F$      |     | 1.0  | 1.3 | V         |
| Breakdown Voltage    | $I_R = 20\text{ }\mu\text{A}$ , $E = 0$           | $V_{(BR)}$ | 10  |      |     | V         |
| Reverse Dark Current | $V_R = 5\text{ V}$ , $E = 0$                      | $I_{ro}$   |     | 2    | 30  | nA        |
| Diode capacitance    | $V_R = 0\text{ V}$ , $f = 1\text{ MHz}$ , $E = 0$ | $C_D$      |     | 1.2  |     | nF        |
|                      | $V_R = 5\text{ V}$ , $f = 1\text{ MHz}$ , $E = 0$ | $C_D$      |     | 400  |     | pF        |
| Dark Resistance      | $V_R = 10\text{ mV}$                              | $R_D$      |     | 38   |     | $G\Omega$ |

### Optical Characteristics

$T_{amb} = 25\text{ }^{\circ}\text{C}$ , unless otherwise specified

| Parameter                      | Test condition  | Symbol          | Min | Typ.       | Max | Unit          |
|--------------------------------|---|-----------------|-----|------------|-----|---------------|
| Open Circuit Voltage           | $E_A = 1\text{ klx}$  | $V_o$           | 280 | 450        |     | mV            |
| Temp. Coefficient of $V_o$     | $E_A = 1\text{ klx}$  | $TK_{V_o}$      |     | - 2        |     | mV/K          |
| Short Circuit Current          | $E_A = 1\text{ klx}$  | $I_k$           | 4.5 | 9          |     | $\mu\text{A}$ |
| Temp. Coefficient of $I_k$     | $E_A = 1\text{ klx}$  | $TK_{I_k}$      |     | - 0.05     |     | %/K           |
| Reverse Light Current          | $E_A = 1\text{ klx}$ , $V_R = 5\text{ V}$                                 | $I_{ra}$        | 4.5 | 9          |     | $\mu\text{A}$ |
| Sensitivity                    | $V_R = 5\text{ V}$ , $E_A = 10^{-2}\text{ to }10^5\text{ lx}$             | $S$             |     | 9          |     | nA/lx         |
| Angle of Half Sensitivity      |   | $\phi$          |     | $\pm 50$   |     | deg           |
| Wavelength of Peak Sensitivity |   | $\lambda_p$     |     | 565        |     | nm            |
| Range of Spectral Bandwidth    |   | $\lambda_{0.5}$ |     | 420 to 675 |     | nm            |
| Rise Time                      | $V_R = 0\text{ V}$ , $R_L = 1\text{ k}\Omega$ , $\lambda = 660\text{ nm}$ | $t_r$           |     | 3.1        |     | $\mu\text{s}$ |
| Fall Time                      | $V_R = 0\text{ V}$ , $R_L = 1\text{ k}\Omega$ , $\lambda = 660\text{ nm}$ | $t_f$           |     | 3.0        |     | $\mu\text{s}$ |

### Typical Characteristics

$T_{amb} = 25\text{ }^{\circ}\text{C}$  unless otherwise specified

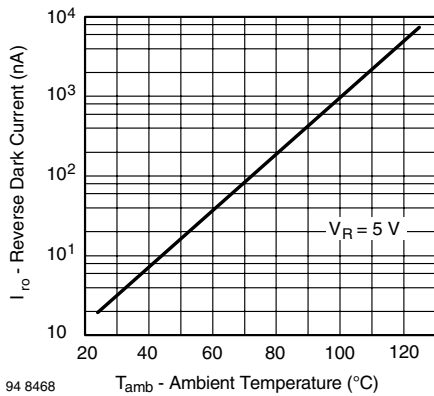

Figure 1. Reverse Dark Current vs. Ambient Temperature

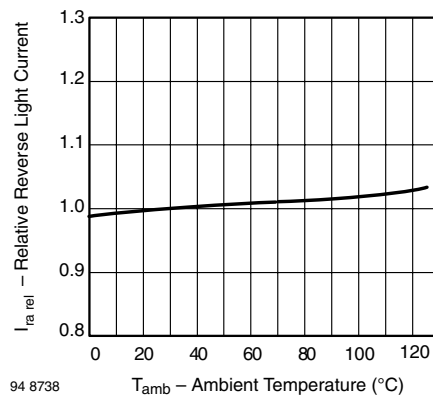
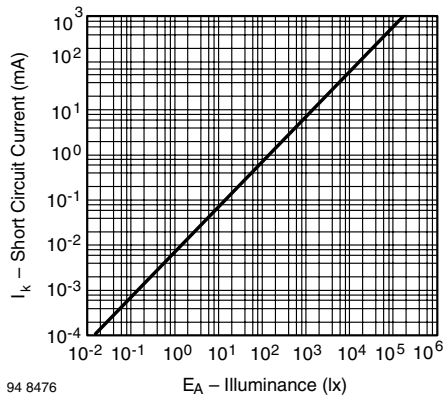
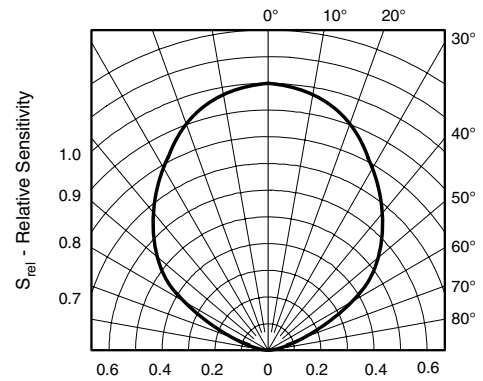

Figure 2. Relative Reverse Light Current vs. Ambient Temperature



94 8476

Figure 3. Short Circuit Current vs. Illuminance



94 8475

Figure 6. Relative Radiant Sensitivity vs. Angular Displacement

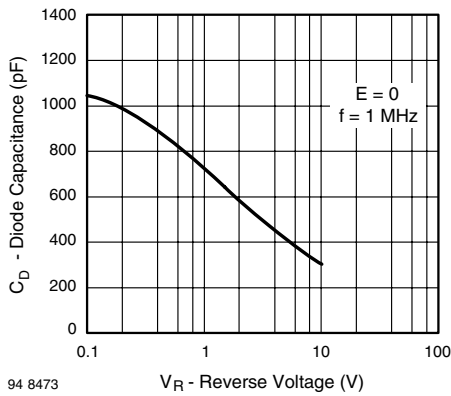

94 8473

Figure 4. Diode Capacitance vs. Reverse Voltage

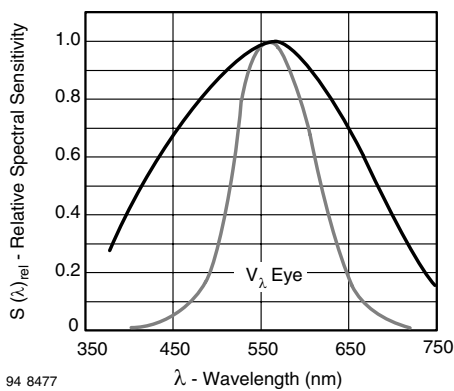

94 8477

Figure 5. Relative Spectral Sensitivity vs. Wavelength

# BPW21R

Vishay Semiconductors



## Package Dimensions in mm

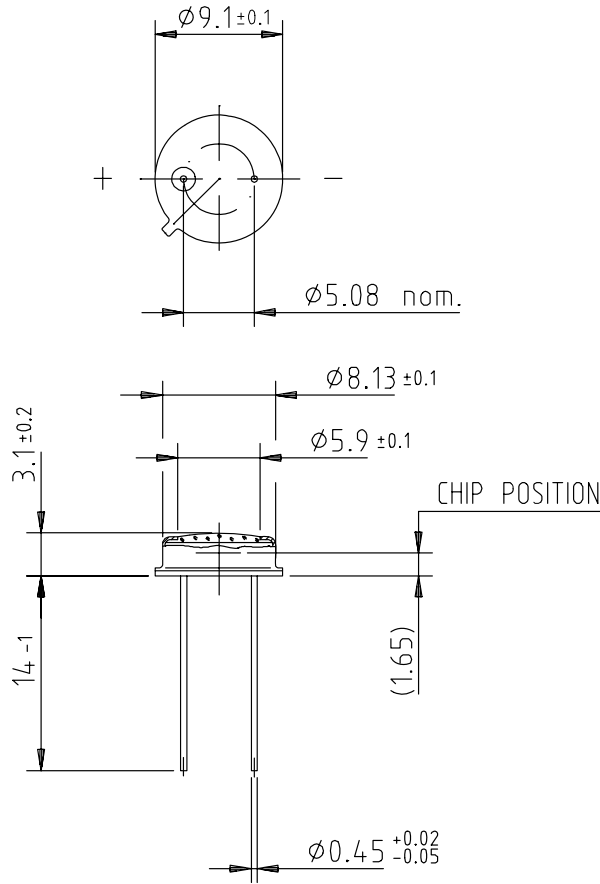

96 12181

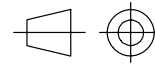

technical drawings  
according to DIN  
specifications

**Ozone Depleting Substances Policy Statement**

It is the policy of Vishay Semiconductor GmbH to

1. Meet all present and future national and international statutory requirements.
2. Regularly and continuously improve the performance of our products, processes, distribution and operating systems with respect to their impact on the health and safety of our employees and the public, as well as their impact on the environment.

It is particular concern to control or eliminate releases of those substances into the atmosphere which are known as ozone depleting substances (ODSs).

The Montreal Protocol (1987) and its London Amendments (1990) intend to severely restrict the use of ODSs and forbid their use within the next ten years. Various national and international initiatives are pressing for an earlier ban on these substances.

Vishay Semiconductor GmbH has been able to use its policy of continuous improvements to eliminate the use of ODSs listed in the following documents.

1. Annex A, B and list of transitional substances of the Montreal Protocol and the London Amendments respectively
2. Class I and II ozone depleting substances in the Clean Air Act Amendments of 1990 by the Environmental Protection Agency (EPA) in the USA
3. Council Decision 88/540/EEC and 91/690/EEC Annex A, B and C (transitional substances) respectively.

Vishay Semiconductor GmbH can certify that our semiconductors are not manufactured with ozone depleting substances and do not contain such substances.

We reserve the right to make changes to improve technical design  
and may do so without further notice.

Parameters can vary in different applications. All operating parameters must be validated for each customer application by the customer. Should the buyer use Vishay Semiconductors products for any unintended or unauthorized application, the buyer shall indemnify Vishay Semiconductors against all claims, costs, damages, and expenses, arising out of, directly or indirectly, any claim of personal damage, injury or death associated with such unintended or unauthorized use.

Vishay Semiconductor GmbH, P.O.B. 3535, D-74025 Heilbronn, Germany



## Disclaimer

All product specifications and data are subject to change without notice.

Vishay Intertechnology, Inc., its affiliates, agents, and employees, and all persons acting on its or their behalf (collectively, "Vishay"), disclaim any and all liability for any errors, inaccuracies or incompleteness contained herein or in any other disclosure relating to any product.

Vishay disclaims any and all liability arising out of the use or application of any product described herein or of any information provided herein to the maximum extent permitted by law. The product specifications do not expand or otherwise modify Vishay's terms and conditions of purchase, including but not limited to the warranty expressed therein, which apply to these products.

No license, express or implied, by estoppel or otherwise, to any intellectual property rights is granted by this document or by any conduct of Vishay.

The products shown herein are not designed for use in medical, life-saving, or life-sustaining applications unless otherwise expressly indicated. Customers using or selling Vishay products not expressly indicated for use in such applications do so entirely at their own risk and agree to fully indemnify Vishay for any damages arising or resulting from such use or sale. Please contact authorized Vishay personnel to obtain written terms and conditions regarding products designed for such applications.

Product names and markings noted herein may be trademarks of their respective owners.