

PLEASE CHECK WWW.MOLEX.COM FOR LATEST PART INFORMATION

Part Number: **0754334105**
Status: **Active**
Overview: [gbx_backplane_connector_system](#)
Description: 1.85mm by 1.85mm (.073 by .073") Pitch 3-Pair GbX® Backplane Connector System, Right Guide Header, 60 Circuits, Gold (Au) 0.76µm (30µ"), Pin Length 5.55mm (.219")

Documents:

[Drawing \(PDF\)](#) [Product Specification PS-75221-999 \(PDF\)](#)
[Packaging Specification \(PDF\)](#) [RoHS Certificate of Compliance \(PDF\)](#)

Agency Certification

UL E29179

General

Product Family Backplane Connectors
Series [75433](#)
Application Backplane
Application Tooling Documents [Tooling Manual](http://www.molex.com/pdm_docs/ats/TM-622022099.pdf)
Comments Right Guide Header, No Keying Position
Component Type PCB Header
Overview [gbx_backplane_connector_system](#)
Product Name GbX®
Style N/A

Physical

Circuits (Loaded) 60
Circuits (maximum) 60
Color - Resin Black
Durability (mating cycles max) 200
First Mate / Last Break No
Flammability 94V-0
Guide to Mating Part Yes
Keying to Mating Part None
Material - Metal High Performance Alloy (HPA), Stainless Steel
Material - Plating Mating Gold
Material - Plating Termination Tin-Lead
Material - Resin High Temperature Thermoplastic
Number of Columns 10
Number of Pairs 3
Number of Rows 6
Orientation Vertical
PC Tail Length (in) 0.087 In
PC Tail Length (mm) 2.20 mm
PCB Locator No
PCB Retention Yes
PCB Thickness Recommended (in) 0.063 In
PCB Thickness Recommended (mm) 1.60 mm
Packaging Type Tube
Pitch - Mating Interface (in) 0.073 In
Pitch - Mating Interface (mm) 1.85 mm
Pitch - Term. Interface (in) 0.073 In
Pitch - Term. Interface (mm) 1.85 mm
Plating min: Mating (µin) 30
Plating min: Mating (µm) 0.76
Plating min: Termination (µin) 30

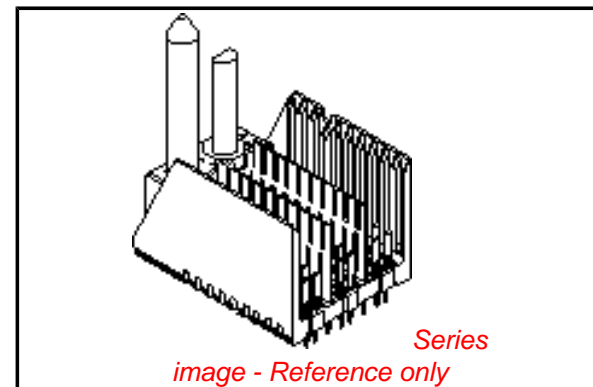

EU RoHS

RoHS Compliant by Exemption
REACH SVHC
Not Reviewed
Halogen-Free
Status

China RoHS



Need more information on product environmental compliance?

Email productcompliance@molex.com
For a multiple part number RoHS Certificate of Compliance, [click here](#)

Please visit the [Contact Us](#) section for any non-product compliance questions.

Search Parts in this Series

[75433Series](#)

Mates With

[75370 GbX® Daughtercards](#)

Application Tooling | FAQ

Tooling specifications and manuals are found by selecting the products below. Crimp Height Specifications are then contained in the Application Tooling Specification document.

Global

Description	Product #
GbX® Single Pin Repair Tool	0622022090
GbX® Shield Removal Tool	0622022100
GbX® 3 Pair by 10 Wide Differential Insertion Tool	0622022510

Plating min: Termination (µm)	0.76
Polarized to PCB	No
Stackable	No
Surface Mount Compatible (SMC)	Yes
Temperature Range - Operating	105°C
Termination Interface: Style	Through Hole - Compliant Pin

Electrical

Current - Maximum per Contact	1A
Data Rate	8.0 Gbps
Real Signals (per 25mm)	81
Shield Type	Ground Plane Shield
Shielded	Yes
Voltage - Maximum	120V AC (RMS)/DC

Material Info

Reference - Drawing Numbers

Packaging Specification	PK-70873-572
Product Specification	PS-75221-999
Sales Drawing	SD-75433-410

GbX is a registered trademark of Amphenol Corporation.

This document was generated on 05/25/2010

PLEASE CHECK WWW.MOLEX.COM FOR LATEST PART INFORMATION

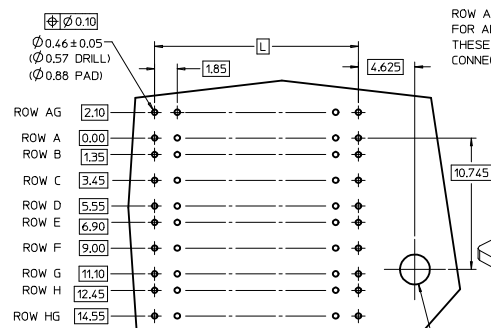
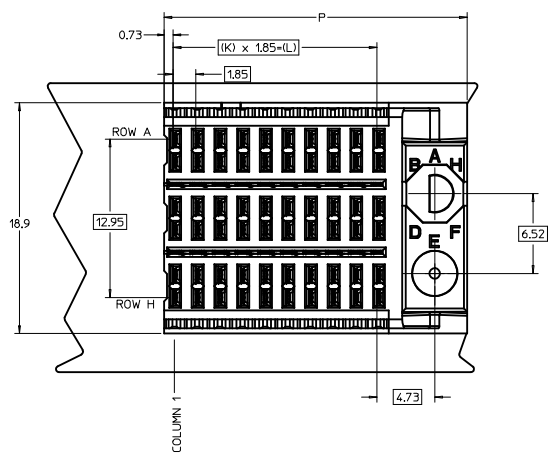

ROW AG & HG RECOMMENDED FOR ALL APPLICATIONS. THESE ROWS SHOULD BE CONNECTED TO GROUND.

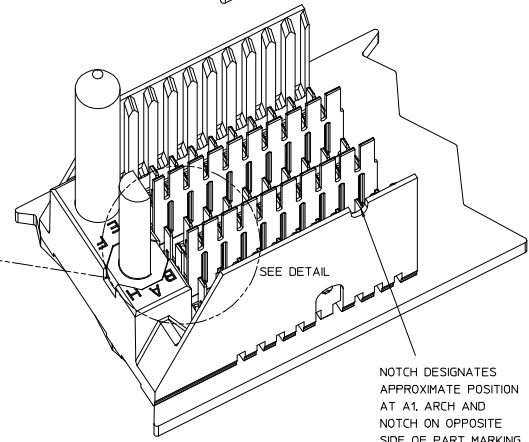
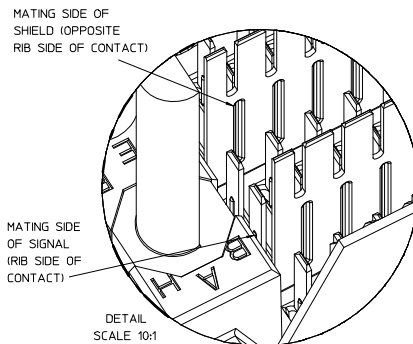
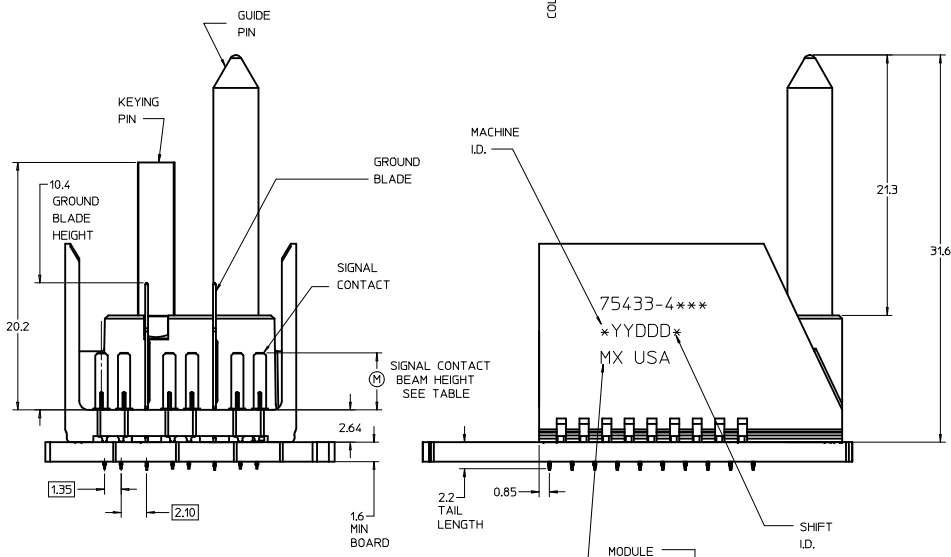
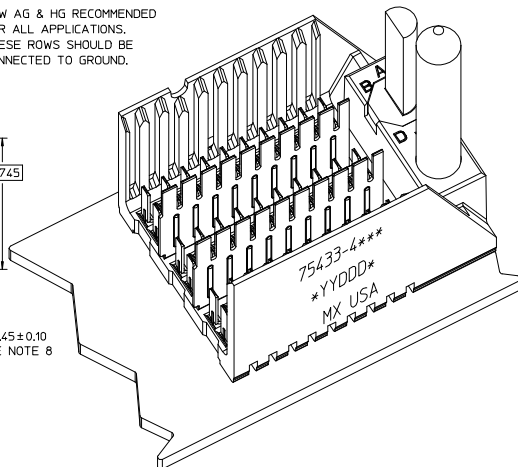

NOTCH DESIGNATES APPROXIMATE POSITION AT A1 ARCH AND NOTCH ON OPPOSITE SIDE OF PART MARKING.

NOTES:

1. MATERIAL: HOUSING - LIQUID CRYSTAL POLYMER (LCP) GLASS-FILLED. UL 94V-0, COLOR - GRAY, SIGNAL CONTACT AND GROUND BLADE - HIGH PERFORMANCE COPPER ALLOY.
2. FINISHES: SELECTIVE GOLD (Au) ON CONTACT AREA. SELECTIVE TIN/LEAD (Sn/Pb) ON PCB TAILS. NICKEL (Ni) OVERALL.
3. THIS PART CONFORMS TO MOLEX PRODUCT SPECIFICATION PS-75221-999.
4. FOR MIXED CONTACT MATING LENGTHS CONSULT MOLEX FOR AVAILABILITY. CONTACT PAIRS MUST BE THE SAME LENGTH.
5. FOR SPECIFIC PART NUMBER AND MATING INFORMATION PLEASE REFER TO CHART.
6. PACKAGE PER PK-70873-572.
7. EITHER MARK PART NUMBER AND DATE CODE APPROXIMATELY WHERE SHOWN OR PLACE A LABEL ON THE TUBE.
8. OPTIONAL HOLE LOCATION FOR GROUNDED GUIDE PIN OR ADDITIONAL GUIDE PIN SUPPORT. FOR GROUNDED GUIDE PIN, HOLE TO BE PLATED, DRILL SIZE $\varnothing 2.58$, PAD SIZE $\varnothing 5.50$.
9. THESE PARTS CONFORM TO MOLEX COSMETIC SPECIFICATION PS-45499-002 CLASS B.

75433-4*** *YYDDD* MX USA

KEYING ORIENTATION
0-NONE
1-A
2-B
ETC...

MODULE ORIENTATION
RIGHT = 4

PIN LENGTH DIM "M"
3=3.55 mm
4=4.55 mm
5=5.55 mm

PART NUMBER TABLE				
ASSY PART NO.	K	L	P	TOTAL NO. OF DIFFERENTIAL PAIRS
75433-41**	9	16.65	24.78	30
75433-42**	24	44.40	52.53	75
75433-45**	4	7.40	15.53	15

P/N	75433-()	0	A	B	C	D	E	F	G	H
KEYING PIN ORIENTATION										

REVISED (MINOR) EC NO: UCP2009-1704 DRAWN: BINGHAM 2009/01/12 CHKD: CHIKD 2009/01/12 APPR: LAURX 2009/01/13 REV 1	QUALITY SYMBOLS -0 -0	GENERAL TOLERANCES (UNLESS SPECIFIED) .mm INCH		SCALE DIMENSION STYLE METRIC MM ONLY	DESIGN UNITS THIRD ANGLE PROJECTION	REVISE ON CAD ONLY		
		4 PLACES ± --- ± --- 3 PLACES ± --- ± --- 2 PLACES ± --- ± --- 1 PLACE ± --- ± --- ANGULAR ± ---°		DRAWN BY NMARTIN 2005/02/20	DATE 2005/02/20	TITLE GBX 3-PAIR RIGHT END BACKPLANE SALES ASSEMBLY		
		DRAFT WHERE APPLICABLE MUST REMAIN WITHIN DIMENSIONS		CHECKED BY SREED 2005/02/20	DATE 2005/02/20	MATERIAL NO. SEE CHART	DOCUMENT NO. SD-75433-410	SHEET NO. 1 OF 1
		THIS DRAWING CONTAINS INFORMATION THAT IS PROPRIETARY TO MOLEX INCORPORATED AND SHOULD NOT BE USED WITHOUT WRITTEN PERMISSION						