



() Preliminary Specification
(V) Final Specification

Module	21.5" Color TFT-LCD
Model Name	M215HW01 V0

Customer	Date
_____	_____
Approved by	
_____	_____
<p>Note: This Specification is subject to change without notice.</p>	



Approved by	Date
<i>Sean Chen</i>	2008/05/09
Prepared by	
<i>Boris Chu</i>	2008/05/09
<p>Desktop Display Business Group / AU Optronics corporation</p>	

Contents

1.0 Handling Precautions	5
2.0 General Description.....	6
2.1 Display Characteristics.....	6
2.2 Optical Characteristics	7
3.0 Functional Block Diagram.....	11
4.0 Absolute Maximum Ratings	12
4.1 TFT LCD Module.....	12
4.2 Backlight Unit	12
4.3 Absolute Ratings of Environment.....	12
5.0 Electrical characteristics.....	13
5.1 TFT LCD Module.....	13
5.1.1 Power Specification.....	13
5.1.2 Signal Electrical Characteristics.....	14
6.0 Signal Characteristic	17
6.1 Pixel Format Image	17
6.2 The input data format.....	17
6.3 Signal Description	18
6.4 Timing Characteristics.....	19
6.5 Timing diagram	20
6.6 Power ON/OFF Sequence	21
7.0 Connector & Pin Assignment	22
7.1 TFT LCD Module.....	22
7.1.1 Pin Assignment	22
7.2 Backlight Unit	23
7.2.1 Signal for Lamp connector.....	23
8.0 Reliability Test.....	24
9.0 Shipping Label	25
10.0 Mechanical Characteristics.....	26

Record of Revision

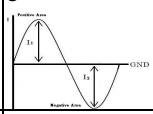
Version and Date	Page	Old description	New Description	Remark
0.1 2008/01/18	All	First Edition for Customer	-	
0.2 2008/05/09	6	Contrast Ratio => 1000 (Typ.) (TBD)	Contrast Ratio => 1000 (Typ.)	Revised
0.2 2008/05/09	6	Nominal Input Voltage VDD => +5.0 V (TBD)	Nominal Input Voltage VDD => +5.0 V	Revised
0.2 2008/05/09	6	Power Consumption => TBD W (Typ.) (VDD line + CCFL line)	Power Consumption => 28.72 W (Typ.) (VDD line + CCFL line)	Revised
0.2 2008/05/09	6	Weight => TBD (Typ.)	Weight => 2188 (Typ.)	Revised
0.2 2008/05/09	7	Contrast ratio Min Typ Max Note 600 1000 3 (TBD)	Contrast ratio Min Typ Max Note 600 1000 3	Revised
0.2 2008/05/09	7	Response Time Raising Time (T _{rR}) Min Typ Max - 3.4 7.4 Falling Time (T _{rF}) Min Typ Max - 1.6 2.6 Raising + Falling Min Typ Max - 5 10	Response Time Raising Time (T _{rR}) Min Typ Max - 3.8 5.5 Falling Time (T _{rF}) Min Typ Max - 1.2 2.5 Raising + Falling Min Typ Max - 5 8	Revised
0.2 2008/05/09	7	Color / Chromaticity Coordinates (CIE) Green x Min Typ Max Note 0.262 0.292 0.322 5 (TBD)	Color / Chromaticity Coordinates (CIE) Green x Min Typ Max Note 0.252 0.282 0.312 5	Revised
0.2 2008/05/09	11	Mating Type: FI-X30HL (Locked Type) FI-X30H (Unlocked Type)	Mating Type: FI-X30HL (Locked Type)	Revised
0.2 2008/05/09	12	4.2 Backlight Unit Item Symbol Min Max CCFL ICFL 3.0 7.5	4.2 Backlight Unit Item Symbol Min Max CCFL ICFL 3.0 8.0	Revised
0.2 2008/05/09	13	IDD : Input Current Min Typ Max - TBD TBD	IDD : Input Current Min Typ Max - 0.9 1.17	Revised
0.2 2008/05/09	13	PDD : VDD Power Min Typ Max - TBD TBD	PDD : VDD Power Min Typ Max - 4.5 5.4	Revised
0.2 2008/05/09	13	IRush : Inrush Current Min Typ Max - - TBD	IRush : Inrush Current Min Typ Max - - 2	Revised
0.2 2008/05/09	15	5.2 Backlight Unit CCFL Frequency (FCFL) Min Typ Max TBD - -	5.2 Backlight Unit CCFL Frequency (FCFL) Min Typ Max 40 55 60	Revised

0.2	2008/05/09	15	Note 1: *2 In case of using an inverter other than listed, it is recommended to check the inverter carefully. Sometimes, interfering noise stripes appear on the screen, and substandard luminance or flicker at low power may happen.	Note 1: *2 It is recommended to check the inverter carefully. Sometimes, interfering noise stripes appear on the screen, and substandard luminance or flicker at low power may happen. *6 For designing CCFL current, it is highly recommended to use symmetric and consistent sinusoidal wave for each CCFL input current with asymmetric ratio of 10% or less in both positive area and negative area (ie. $0.9 \cdot \sqrt{2} \cdot I_{rms} < I_1$ & $I_2 < 1.1 \cdot \sqrt{2} \cdot I_{rms}$) as refer to the following diagram, otherwise proper CCFL functionality cannot be guaranteed. 	Revised																																																																
0.2	2008/05/09	19	6.4 Timing Characteristics <table border="1"> <thead> <tr> <th>Item</th> <th>Min</th> <th>Typ</th> <th>Max</th> </tr> </thead> <tbody> <tr> <td>Data CLK</td> <td>55</td> <td>72</td> <td>90</td> </tr> <tr> <td>H-section</td> <td></td> <td></td> <td></td> </tr> <tr> <td> Period</td> <td>1010</td> <td>1050</td> <td>2047</td> </tr> <tr> <td> Blanking</td> <td>50</td> <td>90</td> <td>681</td> </tr> <tr> <td>V-section</td> <td></td> <td></td> <td></td> </tr> <tr> <td> Period</td> <td>1108</td> <td>1130</td> <td>2047</td> </tr> <tr> <td> Blanking</td> <td>28</td> <td>50</td> <td>255</td> </tr> </tbody> </table>	Item	Min	Typ	Max	Data CLK	55	72	90	H-section				Period	1010	1050	2047	Blanking	50	90	681	V-section				Period	1108	1130	2047	Blanking	28	50	255	6.4 Timing Characteristics <table border="1"> <thead> <tr> <th>Item</th> <th>Min</th> <th>Typ</th> <th>Max</th> </tr> </thead> <tbody> <tr> <td>Data CLK</td> <td>40</td> <td>75</td> <td>90</td> </tr> <tr> <td>H-section</td> <td></td> <td></td> <td></td> </tr> <tr> <td> Period</td> <td>1034</td> <td>1060</td> <td>2047</td> </tr> <tr> <td> Blanking</td> <td>74</td> <td>100</td> <td>1087</td> </tr> <tr> <td>V-section</td> <td></td> <td></td> <td></td> </tr> <tr> <td> Period</td> <td>1088</td> <td>1120</td> <td>2047</td> </tr> <tr> <td> Blanking</td> <td>8</td> <td>40</td> <td>967</td> </tr> </tbody> </table>	Item	Min	Typ	Max	Data CLK	40	75	90	H-section				Period	1034	1060	2047	Blanking	74	100	1087	V-section				Period	1088	1120	2047	Blanking	8	40	967	Revised
Item	Min	Typ	Max																																																																		
Data CLK	55	72	90																																																																		
H-section																																																																					
Period	1010	1050	2047																																																																		
Blanking	50	90	681																																																																		
V-section																																																																					
Period	1108	1130	2047																																																																		
Blanking	28	50	255																																																																		
Item	Min	Typ	Max																																																																		
Data CLK	40	75	90																																																																		
H-section																																																																					
Period	1034	1060	2047																																																																		
Blanking	74	100	1087																																																																		
V-section																																																																					
Period	1088	1120	2047																																																																		
Blanking	8	40	967																																																																		
0.2	2008/05/09	22	7.1 TFT LCD Module Mating Housing Part Number FI-X30HL (Locked Type) FI-X30H (Unlocked Type)	7.1 TFT LCD Module Mating Housing Part Number FI-X30HL (Locked Type)	Revised																																																																
0.2	2008/05/09	23	7.2.1 Signal for Lamp connector Lower Connector No. CN3 Pin No. 1 => Pink Pin No. 2 => White Lower Connector No. CN4 Pin No. 1 => Pink Pin No. 2 => White	7.2.1 Signal for Lamp connector Lower Connector No. CN3 Pin No. 1 => Blue Pin No. 2 => Black Lower Connector No. CN4 Pin No. 1 => Blue Pin No. 2 => Black	Revised																																																																
0.2	2008/05/09	25	9.0 Shipping Label <i>Note 3:</i> The Green Mark will be presented only when the green documents have been ready by AUO Internal Green Team.	9.0 Shipping Label <i>Note 3:</i> For China RoHS compatible products, AUO will add  for identification. <i>Note 4:</i> The Green Mark will be presented only when the green documents have been ready by AUO Internal Green Team.	Revised																																																																
0.2	2008/05/09	26	10.0 Mechanical Characteristics Version 0.1	10.0 Mechanical Characteristics Version 0.2	Revised																																																																
1.0	2008/06/12		Preliminary Specification Version 0.2	Final specification Version 1.0																																																																	
1.1	2008/08/01	6	This specification applies to the 21.5 inch-wide Color a-Si TFT-LCD Module M215HW01. The display supports the WUXGA - 1920(H) x 1080(V) screen format and 16.7M colors (RGB 6-bits + Hi-FRC data).	This specification applies to the 21.5 inch-wide Color a-Si TFT-LCD Module M215HW01. The display supports the Full HD - 1920(H) x 1080(V) screen format and 16.7M colors (RGB 6-bits + Hi-FRC data).	Revised																																																																

1.0 Handling Precautions

- 1) Since front polarizer is easily damaged, pay attention not to scratch it.
- 2) Be sure to turn off power supply when inserting or disconnecting from input connector.
- 3) Wipe off water drop immediately. Long contact with water may cause discoloration or spots.
- 4) When the panel surface is soiled, wipe it with absorbent cotton or other soft cloth.
- 5) Since the panel is made of glass, it may break or crack if dropped or bumped on hard surface.
- 6) Since CMOS LSI is used in this module, take care of static electricity and insure human earth when handling.
- 7) Do not open or modify the Module Assembly.
- 8) Do not press the reflector sheet at the back of the module to any directions.
- 9) In case if a Module has to be put back into the packing container slot after once it was taken out from the container, do not press the center of the CCFL reflector edge. Instead, press at the far ends of the CCFL Reflector edge softly. Otherwise the TFT Module may be damaged.
- 10) At the insertion or removal of the Signal Interface Connector, be sure not to rotate nor tilt the Interface Connector of the TFT Module.
- 11) After installation of the TFT Module into an enclosure, do not twist nor bend the TFT Module even momentary. At designing the enclosure, it should be taken into consideration that no bending/twisting forces are applied to the TFT Module from outside. Otherwise the TFT Module may be damaged.
- 12) Cold cathode fluorescent lamp in LCD contains a small amount of mercury. Please follow local ordinances or regulations for disposal.
- 13) Small amount of materials having no flammability grade is used in the LCD module. The LCD module should be supplied by power complied with requirements of Limited Power Source (IEC60950 or UL1950), or be applied exemption.
- 14) The LCD module is designed so that the CCFL in it is supplied by Limited Current Circuit (IEC60950 or UL1950). Do not connect the CCFL in Hazardous Voltage Circuit.

2.0 General Description

This specification applies to the 21.5 inch-wide Color a-Si TFT-LCD Module M215HW01. The display supports the Full HD - 1920(H) x 1080(V) screen format and 16.7M colors (RGB 6-bits + Hi-FRC data). All input signals are 2-channel LVDS interface and this module doesn't contain an inverter board for backlight.

2.1 Display Characteristics

The following items are characteristics summary on the table under 25°C condition:

ITEMS	Unit	SPECIFICATIONS
Screen Diagonal	[mm]	546.86(21.53")
Active Area	[mm]	476.64 (H) x 268.11 (V)
Pixels H x V		1920(x3) x 1080
Pixel Pitch	[um]	248.25 (per one triad) x248.25
Pixel Arrangement		R.G.B. Vertical Stripe
Display Mode		TN Mode, Normally White
White Luminance (Center)	[cd/m ²]	300 cd/m ² (Typ.)
Contrast Ratio		1000 (Typ.)
Optical Response Time	[msec]	5ms (Typ., on/off)
Nominal Input Voltage VDD	[Volt]	+5.0 V
Power Consumption (VDD line + CCFL line)	[Watt]	28.72W (Typ.) (without inverter, all black pattern)
Weight	[Grams]	2188 (Typ.)
Physical Size	[mm]	495.6(W) x 292.2(H) x 16.35(D) typ
Electrical Interface		Dual channel LVDS
Support Color		16.7M colors (RGB 6-bit + Hi_FRC)
Surface Treatment		Anti-Glare, 3H
Temperature Range		
Operating	[°C]	0 to +50
Storage (Shipping)	[°C]	-20 to +60
RoHS Compliance		RoHS Compliance

2.2 Optical Characteristics

The optical characteristics are measured under stable conditions at 25°C :

Item	Unit	Conditions	Min.	Typ.	Max.	Note
Viewing Angle	[degree]	Horizontal (Right) CR = 10 (Left)	150	170	-	2
		Vertical (Up) CR = 10 (Down)	140	160	-	
Contrast ratio		Normal Direction	600	1000	-	3
Response Time	[msec]	Raising Time (T _{rR})	-	3.8	5.5	4
		Falling Time (T _{rF})	-	1.2	2.5	
		Raising + Falling	-	5	8	
Color / Chromaticity Coordinates (CIE)		Red x	0.618	0.648	0.678	5
		Red y	0.309	0.339	0.369	
		Green x	0.252	0.282	0.312	
		Green y	0.573	0.603	0.633	
		Blue x	0.113	0.143	0.173	
		Blue y	0.040	0.070	0.100	
Color Coordinates (CIE) White		White x	0.283	0.313	0.343	5
		White y	0.299	0.329	0.359	
Central Luminance	[cd/m ²]		240	300	-	6
Luminance Uniformity	[%]		75	80	-	7
Crosstalk (in 60Hz)	[%]				1.5	8
Flicker	dB				-20	9

Note 1: Measurement method

The LCD module should be stabilized at given temperature for 30 minutes to avoid abrupt temperature change during measuring (at surface 35°C). In order to stabilize the luminance, the measurement should be executed after lighting Backlight for 30 minutes in a stable, windless and dark room.

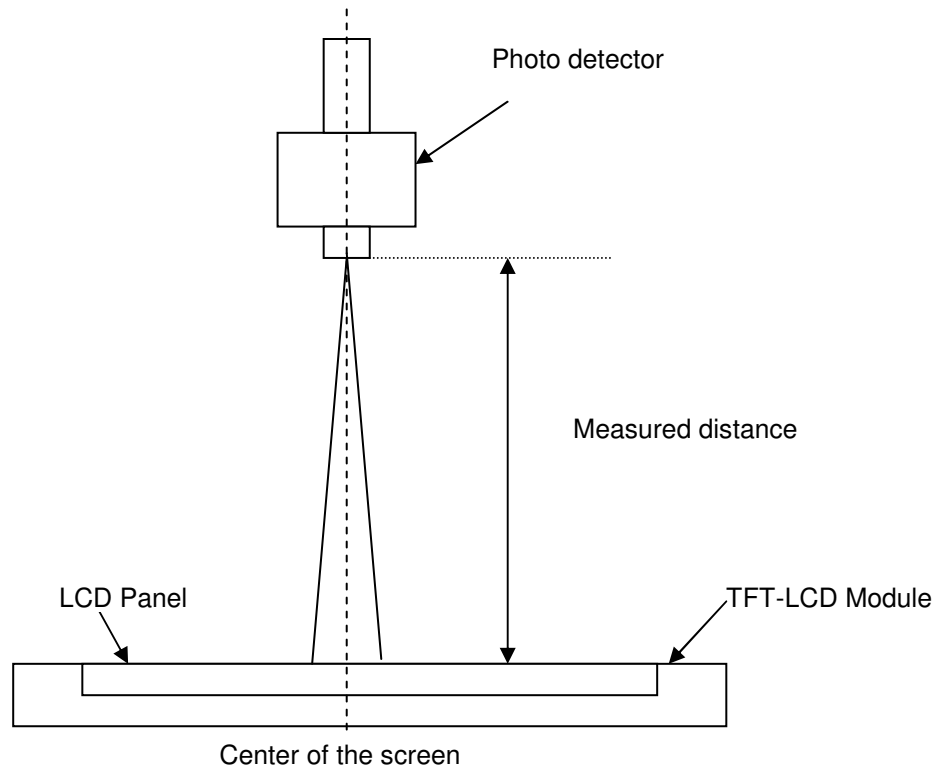

Note 2: Definition of viewing angle measured by ELDIM (EZContrast 88)

Viewing angle is the measurement of contrast ratio ≥ 10 , at the screen center, over a 180° horizontal and 180° vertical range (off-normal viewing angles). The 180° viewing angle range is broken down as follows; 90° (θ) horizontal left and right and 90° (ϕ) vertical, high (up) and low (down). The measurement direction is typically perpendicular to the display surface with the screen rotated about its center to develop the desired measurement viewing angle.

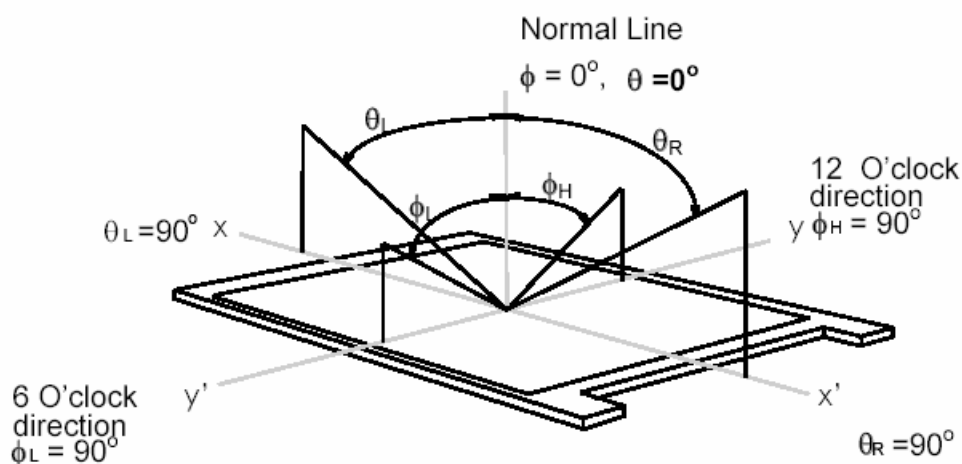

Note 3: Contrast ratio is measured by TOPCON SR-3

Note 4: Definition of Response time measured by Westar TRD-100A

The output signals of photo detector are measured when the input signals are changed from “Full Black” to “Full White” (rising time, Tr_R), and from “Full White” to “Full Black” (falling time, Tf_F), respectively. The response time is interval between the 10% and 90% (1 frame at 60 Hz) of amplitudes.

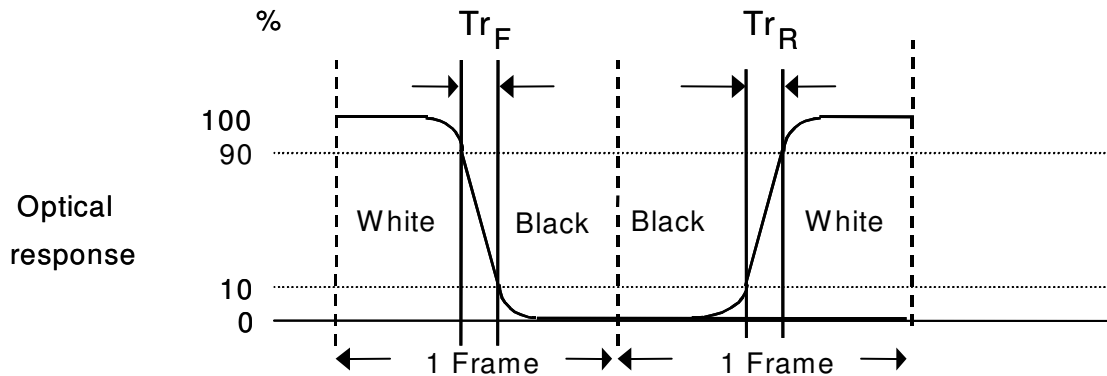

$Tr_R + Tf_F = 5 \text{ msec (typ.)}$.

Algorithm: $| \text{Gray Level A} - \text{Gray Level B} | \geq 16$, then the average gray to gray response time is 2 ms, (F= 60 Hz).

Note 5: Color chromaticity and coordinates (CIE) is measured by TOPCON SR-3

Note 6: Central luminance is measured by TOPCON SR-3

Note 7: Luminance uniformity of these 9 points is defined as below and measured by TOPCON SR-3

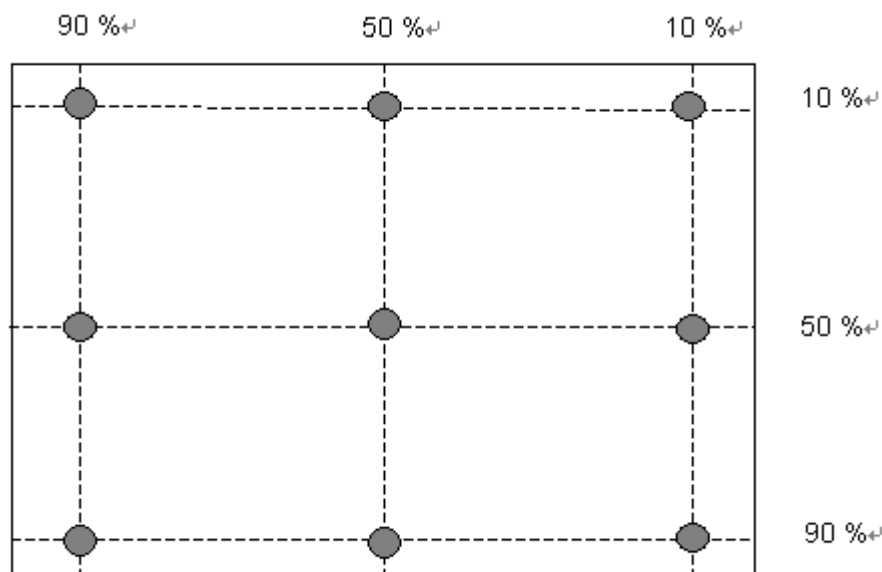

$$\text{Uniformity} = \frac{\text{Minimum Luminance in 9 points (1-9)}}{\text{Maximum Luminance in 9 Points (1-9)}}$$

Note 8: Crosstalk is defined as below and measured by TOPCON SR-3

$$CT = | Y_B - Y_A | / Y_A \times 100 (\%)$$

Where

Y_A = Luminance of measured location without gray level 0 pattern (cd/m²)

Y_B = Luminance of measured location with gray level 0 pattern (cd/m²)

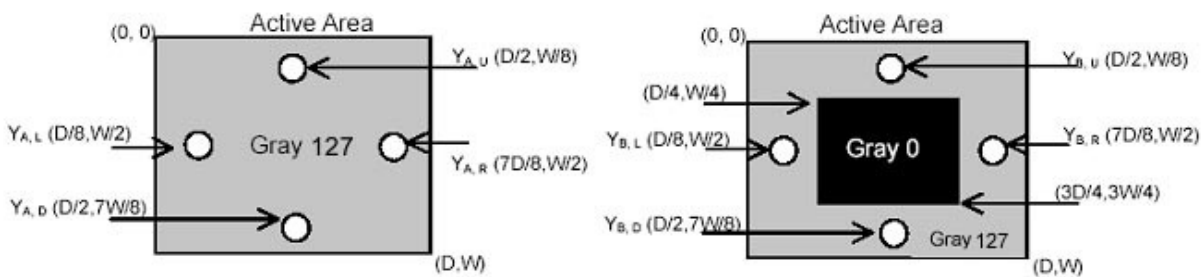

Note 9: Test Pattern: Subchecker Pattern measured by TOPCON SR-3

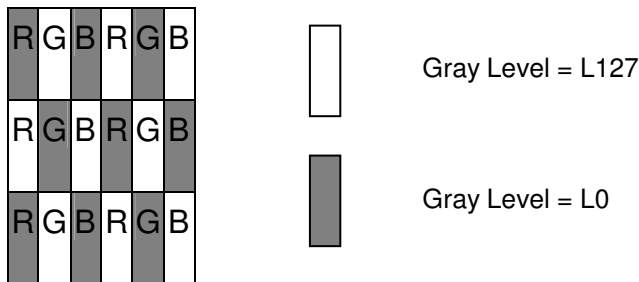

Method: Record dBV & DC value with TRD-100

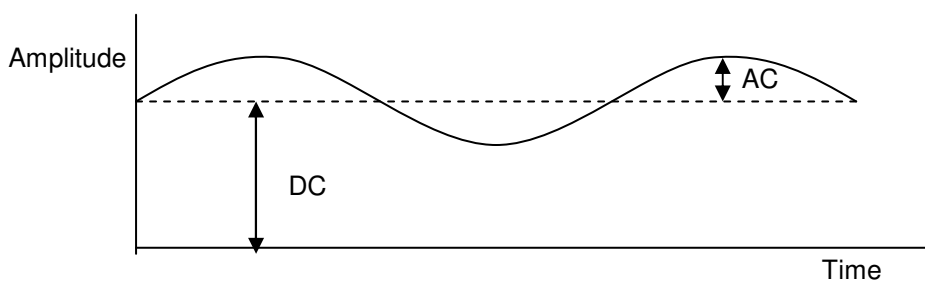

$$\text{Flicker (dB)} = 20 \log \frac{\text{AC Level (at 30 Hz)}}{\text{DC Level}}$$

3.0 Functional Block Diagram

The following diagram shows the functional block of the 21.5 inch Color TFT-LCD Module:

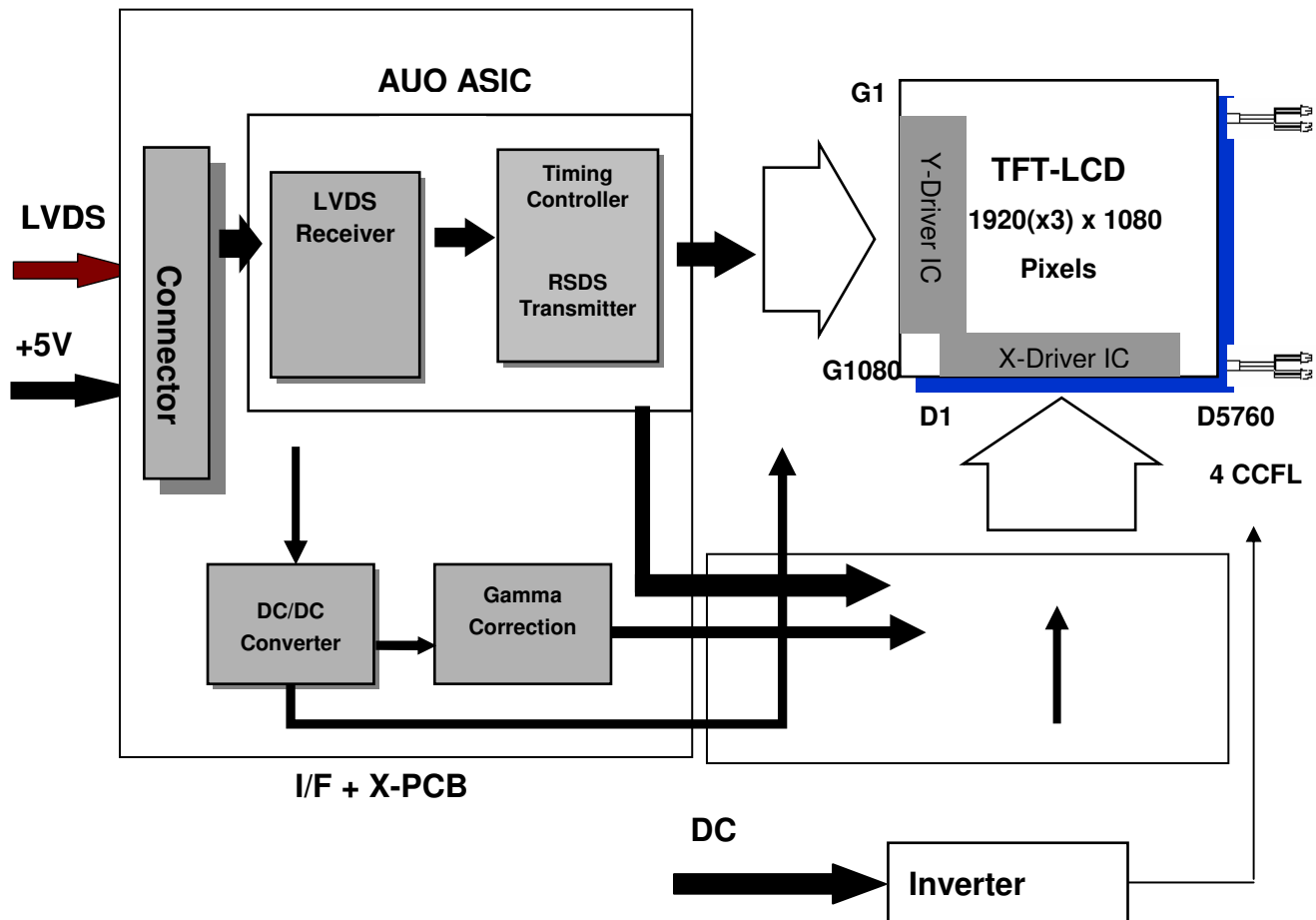

I/F PCB Interface:

FI-XB30SSRL-HF16 (JAE)
or AL230F-A0G1D-P(P-TWO)

Mating Type:

FI-X30HL (Locked Type)

4.0 Absolute Maximum Ratings

Absolute maximum ratings of the module are as following:

4.1 TFT LCD Module

Item	Symbol	Min	Max	Unit	Conditions
Logic/LCD Drive Voltage	VDD	0	5.5	[Volt]	<i>Note 1,2</i>

4.2 Backlight Unit

Item	Symbol	Min	Max	Unit	Conditions
CCFL Current	ICFL	3.0	8.0	[mA] rms	<i>Note 1,2</i>

4.3 Absolute Ratings of Environment

Item	Symbol	Min.	Max.	Unit	Conditions
Operating Temperature	TOP	0	+50	[°C]	<i>Note 3</i>
Operation Humidity	HOP	5	90	[%RH]	
Storage Temperature	TST	-20	+60	[°C]	
Storage Humidity	HST	5	90	[%RH]	

Note 1: With in Ta (25°C)

Note 2: Permanent damage to the device may occur if exceeding maximum values

Note 3: For quality performance, please refer to AUO IIS(Incoming Inspection Standard).

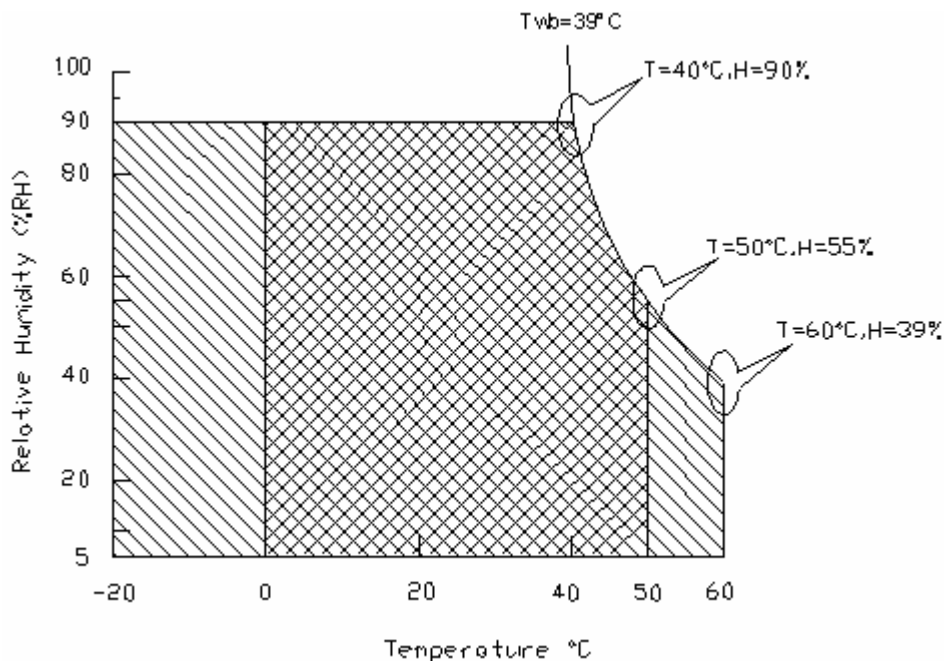

Operating Range



Storage Range

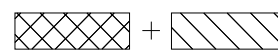

5.0 Electrical characteristics

5.1 TFT LCD Module

5.1.1 Power Specification

Input power specifications are as following:

Symbol	Parameter	Min	Typ	Max	Unit	Conditions
VDD	Logic/LCD Drive Voltage	4.5	5.0	5.5	[Volt]	+/-10%
IDD	Input Current	-	0.9	1.17	[A]	VDD= 5.0V, All Black Pattern At 75Hz, +30%
PDD	VDD Power	-	4.5	5.4	[Watt]	VDD= 5.0V, All Black Pattern At 75Hz
IRush	Inrush Current	-	-	2	[A]	Note 1
VDDrp	Allowable Logic/LCD Drive Ripple Voltage	-	-	300	[mV] p-p	VDD= 5.0V, All Black Pattern At 75Hz

Note 1: Measurement conditions:

The duration of rising time of power input is 470us.

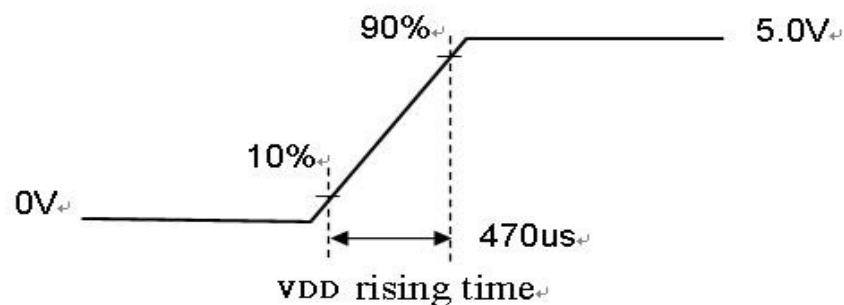
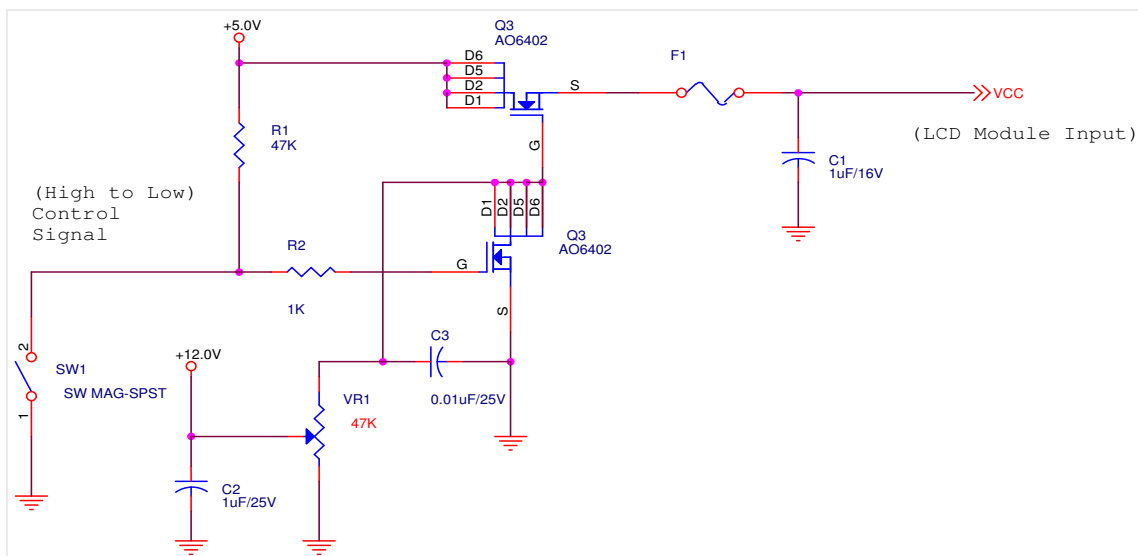

5.1.2 Signal Electrical Characteristics

Input signals shall be low or Hi-Z state when VDD is off. Please refer to specifications of SN75LVDS82DGG (Texas Instruments) in detail.

Characteristics of each signal are as following:

Symbol	Parameter	Min	Typ	Max	Units	Condition
VTH	Differential Input High Threshold	-	+50	+100	[mV]	VICM = 1.2V Note 1
VTL	Differential Input Low Threshold	-100	-50	-	[mV]	VICM = 1.2V Note 1
VID	Input Differential Voltage	100	-	600	[mV]	Note 1
VICM	Differential Input Common Mode Voltage	+1.0	+1.2	+1.5	[V]	VTH-VTL = 200MV (max) Note 1

Note 1: LVDS Signal Waveform

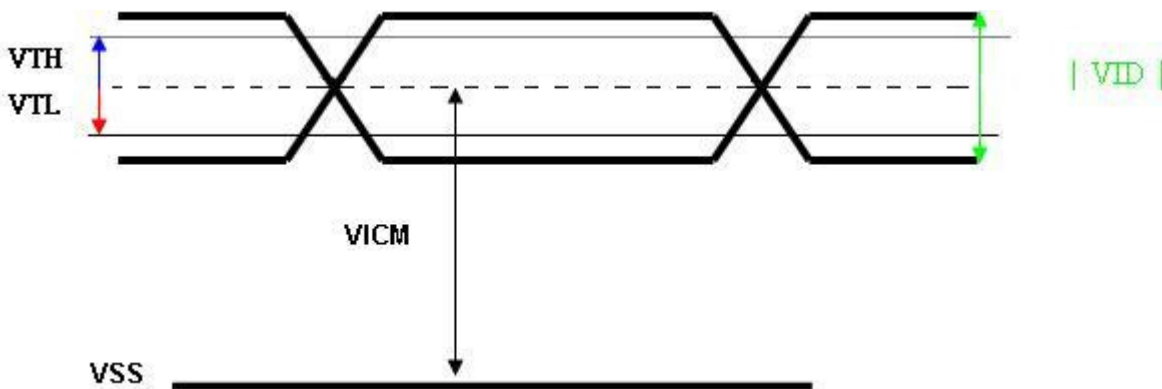

5.2 Backlight Unit

Parameter guideline for CCFL Inverter is under stable conditions at 25°C (Room Temperature):

Parameter	Min.	Typ.	Max.	Unit	Note
CCFL Standard Current (ISCFL)	7.0	7.5	8.0	[mA] rms	
CCFL Operation Current (IRCFL)	3.0	7.5	8.0	[mA] rms	2
CCFL Frequency (FCFL)	40	55	60	[KHz]	3, 4
CCFL Ignition Voltage (ViCFL, Ta= 0°C)	1780	-	-	[Volt] rms	5
CCFL Ignition Voltage (ViCF, Ta= 25°C)	1380	-	-	[Volt] rms	
CCFL Operation Voltage (VCFL)	-	791 (@ 7.5mA)	880	[Volt] rms	6
CCFL Power Consumption (PCFL)	-	23.7	26.4	[Watt]	
CCFL Life Time (LTCFL)	40,000	50,000	-	[Hour]	7

Note 1: Typ. values are AUO recommended design values.

*1 All of characteristics listed are measured under the condition using the AUO test inverter.

*2 It is recommended to check the inverter carefully. Sometimes, interfering noise stripes appear on the screen, and substandard luminance or flicker at low power may happen.

*3 While designing an inverter, it is suggested to check safety circuit very carefully. Impedance of CCFL, for instance, becomes more than 1 [M ohm] when CCFL is damaged.

*4 Generally, CCFL has certain delay time after applying kick-off voltage. It is recommended to keep on applying kick-off voltage for 1 [Sec] until discharge.

*5 Reducing CCFL current will increase CCFL discharge voltage and generally increases CCFL discharge frequency. So all the parameters of the inverter should be carefully designed so the inverter will not produce too much leakage current from high-voltage output.

*6 For designing CCFL current, it is highly recommended to use symmetric and consistent sinusoidal wave for each CCFL input current with asymmetric ration of 10% or less in both positive area and negative area (ie. $0.9 \cdot \sqrt{2} \cdot I_{rms} < I_1$ & $I_2 < 1.1 \cdot \sqrt{2} \cdot I_{rms}$) as refer to the following diagram, otherwise proper CCFL functionality cannot be guaranteed.

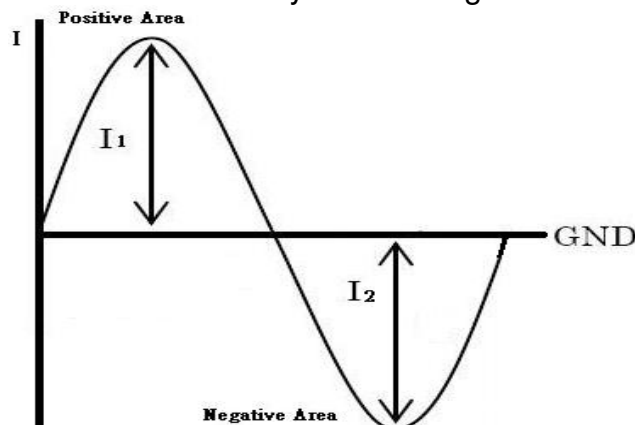



Note 2: CCFL standard current is measured at $25\pm 2^{\circ}\text{C}$.

Note 3: CCFL discharge frequency should be carefully determined to avoid interference between inverter and TFT LCD.

Note 4: The frequency range will not affect lamp life and reliability characteristics.

Note 5: CCFL inverter should be able to release power that has generating capacity exceeding 1780 volt. Lamp units need minimum voltage, 1780 Volt, for ignition.

Note 6: The variance of CCFL power consumption is $\pm 10\%$. ($\text{IRCFL} \times \text{VCFL} \times 4 = \text{PCFL}$)

Note 7: Definition of life time: brightness becomes 50%. The minimum life time of CCFL unit is on the condition of 7.5mA CCFL current and $25\pm 2^{\circ}\text{C}$.

6.0 Signal Characteristic

6.1 Pixel Format Image

Following figure shows the relationship of the input signals and LCD pixel format.

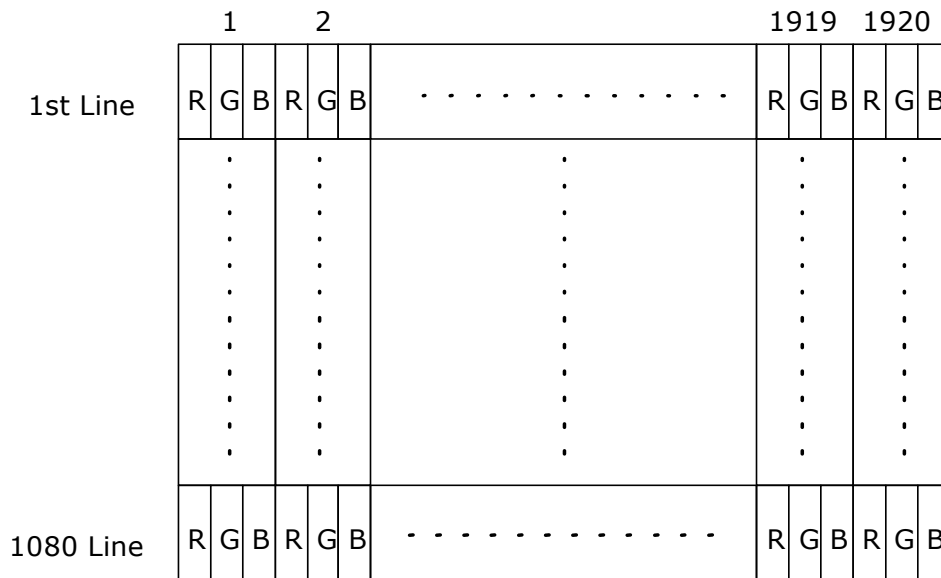

6.2 The input data format

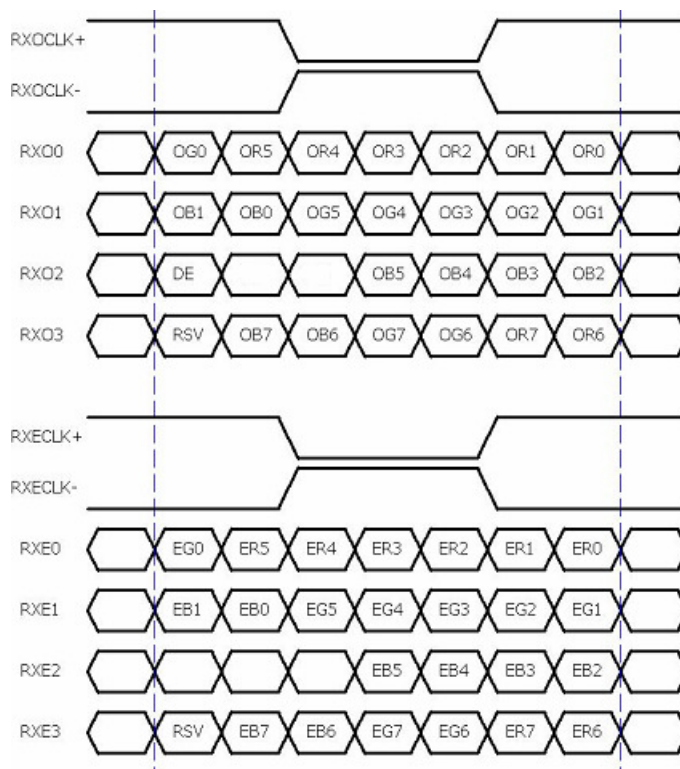

Note 1: R/G/B data 7:MSB, R/G/B data 0:LSB O = "First Pixel Data" E = "Second Pixel Data"

6.3 Signal Description

The module using one LVDS receiver SN75LVDS82(Texas Instruments). LVDS is a differential signal technology for LCD interface and high speed data transfer device. LVDS transmitters shall be SN75LVDS83(negative edge sampling). The first LVDS port(RxOxxx) transmits odd pixels while the second LVDS port(RxExxx) transmits even pixels.

PIN #	SIGNAL NAME	DESCRIPTION
1	RxOIN0-	Negative LVDS differential data input (Odd data)
2	RxOIN0+	Positive LVDS differential data input (Odd data)
3	RxOIN1-	Negative LVDS differential data input (Odd data)
4	RxOIN1+	Positive LVDS differential data input (Odd data)
5	RxOIN2-	Negative LVDS differential data input (Odd data,DSPTMG)
6	RxOIN2+	Positive LVDS differential data input (Odd data,DSPTMG)
7	GND	Power Ground
8	RxOCLK-	Negative LVDS differential clock input (Odd clock)
9	RxOCLK+	Positive LVDS differential clock input (Odd clock)
10	RxOIN3-	Negative LVDS differential data input (Odd data)
11	RxOIN3+	Positive LVDS differential data input (Odd data)
12	RxEIN0-	Negative LVDS differential data input (Even data)
13	RxEIN0+	Positive LVDS differential data input (Even data)
14	GND	Power Ground
15	RxEIN1-	Positive LVDS differential data input (Even data)
16	RxEIN1+	Negative LVDS differential data input (Even data)
17	GND	Power Ground
18	RxEIN2-	Negative LVDS differential data input (Even data)
19	RxEIN2+	Positive LVDS differential data input (Even data)
20	RxECLK-	Negative LVDS differential clock input (Even clock)
21	RxECLK+	Positive LVDS differential clock input (Even clock)
22	RxEIN3-	Negative LVDS differential data input (Even data)
23	RxEIN3+	Positive LVDS differential data input (Even data)
24	GND	Power Ground
25	NC	No connection (for AUO test only. Do not connect)
26	NC	No connection (for AUO test only. Do not connect)
27	NC	No connection (for AUO test only. Do not connect)
28	VDD	Power +5V
29	VDD	Power +5V
30	VDD	Power +5V

Note1: Start from left side

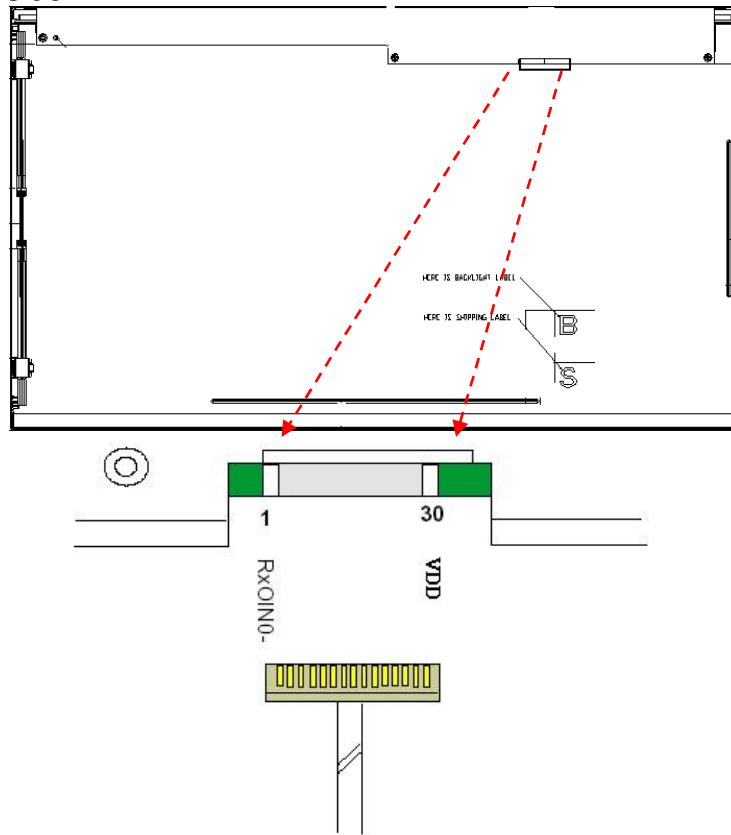

Note2: Input signals of odd and even clock shall be the same timing.

6.4 Timing Characteristics

Basically, interface timing described here is not actual input timing of LCD module but close to output timing of SN75LVDS82DGG (Texas Instruments) or equivalent.

Item	Symbol	Min	Typ	Max	Unit	
Data CLK	Tclk	40	75	90	[MHz]	
H-section	Period	Th	1034	1060	2047	[Tclk]
	Display Area	Tdisp(h)	960	960	960	[Tclk]
	Blanking	Tblk(h)	74	100	1087	[Tclk]
V-section	Period	Tv	1088	1120	2047	[Th]
	Display Area	Tdisp(h)	1080	1080	1080	[Th]
	Blanking	Tblk(h)	8	40	967	[Th]
Frame Rate	F	50	60	75	[Hz]	

Note : DE mode only

6.5 Timing diagram

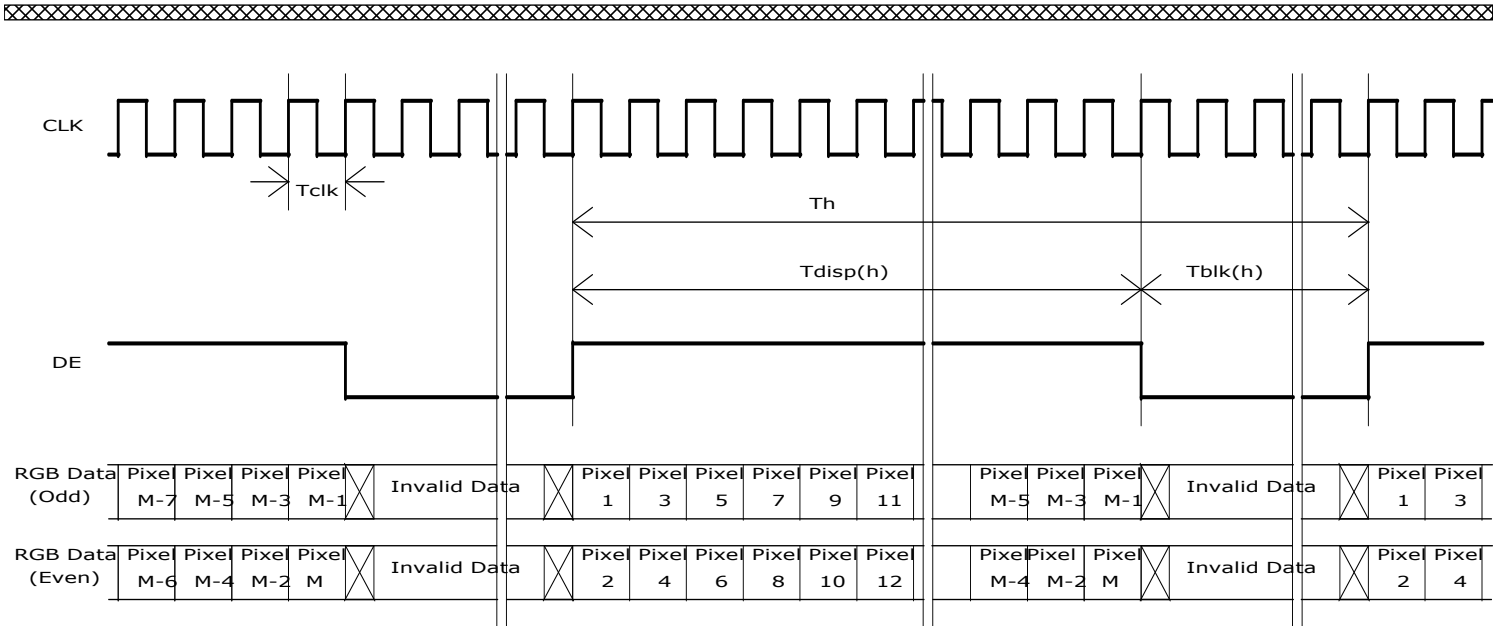
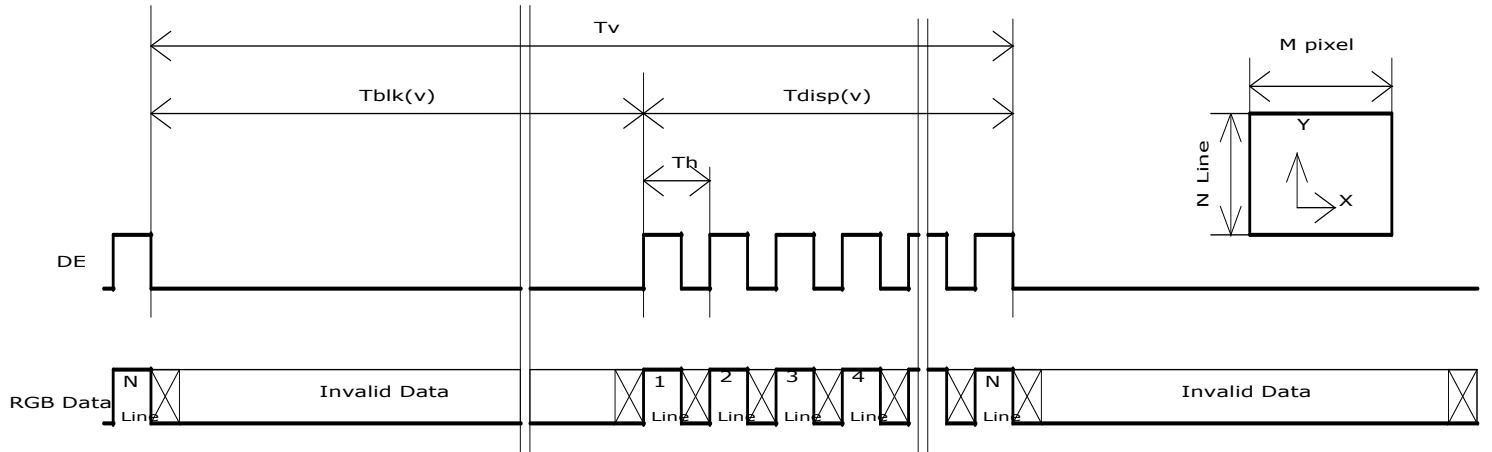

6.6 Power ON/OFF Sequence

VDD power and lamp on/off sequence are as follows. Interface signals are also shown in the chart. Signals from any system shall be Hi-Z state or low level when VDD is off.

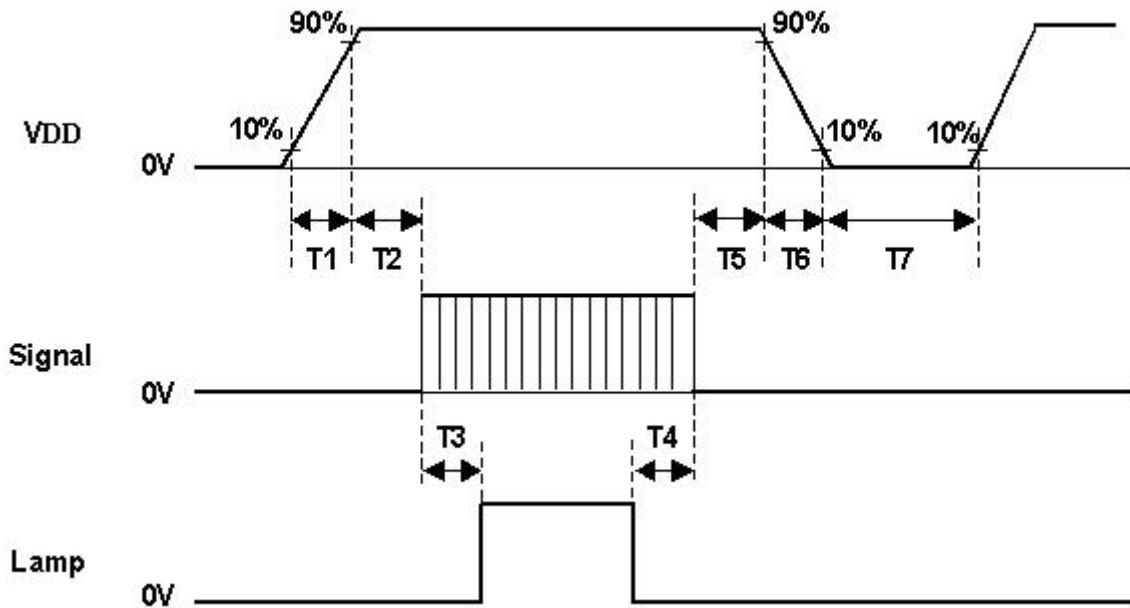

Parameter	Value			Unit
	Min.	Typ.	Max.	
T1	0.5	-	10	[msec]
T2	0	-	50	[msec]
T3	200	-	-	[msec]
T4	200	-	-	[msec]
T5	0	16	50	[msec]
T6	-	-	100	[msec]
T7	1000	-	-	[msec]

7.0 Connector & Pin Assignment

Physical interface is described as for the connector on module. These connectors are capable of accommodating the following signals and will be following components.

7.1 TFT LCD Module

Connector Name / Designation	Interface Connector / Interface card
Manufacturer	JAE / P-TWO
Type Part Number	FI-XB30SSRL-HF16 / AL230F-A0G1D-P
Mating Housing Part Number	FI-X30HL (Locked Type)

7.1.1 Pin Assignment

Pin#	Signal Name	Pin#	Signal Name
1	RxOIN0-	2	RxOIN0+
3	RxOIN1-	4	RxOIN1+
5	RxOIN2-	6	RxOIN2+
7	GND	8	RxOCLKIN-
9	RxOCLKIN+	10	RxOIN3-
11	RxOIN3+	12	RxEIN0-
13	RxEIN0+	14	GND
15	RxEIN1-	16	RxEIN1+
17	GND	18	RxEIN2-
19	RxEIN2+	20	RxECLKIN-
21	RxECLKIN+	22	RxEIN3-
23	RxEIN3+	24	GND
25	NC (for AUO test only. Do not connect)	26	NC (for AUO test only. Do not connect)
27	NC (for AUO test only. Do not connect)	28	VDD
29	VDD	30	VDD

7.2 Backlight Unit

Physical interface is described as for the connector on module. These connectors are capable of accommodating the following signals and will be following components.

Connector Name / Designation	Lamp Connector / Backlight lamp
Manufacturer	CVILUX
Type Part Number	CP0502SL090
Mating Type Part Number	CP0502P1ML0

7.2.1 Signal for Lamp connector

	Connector No.	Pin No.	Input	Color	Function
Upper	CN1	1	Hot1	Pink	High Voltage
		2	Cold1	White	Low Voltage
	CN2	1	Hot2	Blue	High Voltage
		2	Cold2	Black	Low Voltage

	Connector No.	Pin No.	Input	Color	Function
Lower	CN3	1	Hot1	Pink	High Voltage
		2	Cold1	White	Low Voltage
	CN4	1	Hot2	Blue	High Voltage
		2	Cold2	Black	Low Voltage

8.0 Reliability Test

Environment test conditions are listed as following table.

Items	Required Condition	Note
Temperature Humidity Bias (THB)	Ta= 50°C , 80%RH, 300hours	
High Temperature Operation (HTO)	Ta= 50°C , 50%RH, 300hours	
Low Temperature Operation (LTO)	Ta= 0°C , 300hours	
High Temperature Storage (HTS)	Ta= 60°C , 300hours	
Low Temperature Storage (LTS)	Ta= -20°C , 300hours	
Vibration Test (Non-operation)	Acceleration: 1.5 Grms Wave: Random Frequency: 10 - 200 Hz Sweep: 30 Minutes each Axis (X, Y, Z)	
Shock Test (Non-operation)	Acceleration: 50 G Wave: Half-sine Active Time: 20 ms Direction: ±X, ±Y, ±Z (one time for each Axis)	
Drop Test	Height: 60 cm, package test	
Thermal Shock Test (TST)	-20°C/30min, 60°C/30min, 100 cycles	1
On/Off Test	On/10sec, Off/10sec, 30,000 cycles	
ESD (Electro Static Discharge)	Contact Discharge: ± 8KV, 150pF(330Ω) 1sec, 8 points, 25 times/ point.	2
	Air Discharge: ± 15KV, 150pF(330Ω) 1sec 8 points, 25 times/ point.	
Altitude Test	Operation:10,000 ft Non-Operation:30,000 ft	

Note 1: The TFT-LCD module will not sustain damage after being subjected to 100 cycles of rapid temperature change. A cycle of rapid temperature change consists of varying the temperature from -20°C to 60°C, and back again. Power is not applied during the test. After temperature cycling, the unit is placed in normal room ambient for at least 4 hours before power on.

Note 2: EN61000-4-2, ESD class B: Certain performance degradation allowed
 No data lost
 Self-recoverable
 No hardware failures.

9.0 Shipping Label

The label is on the panel as shown below:

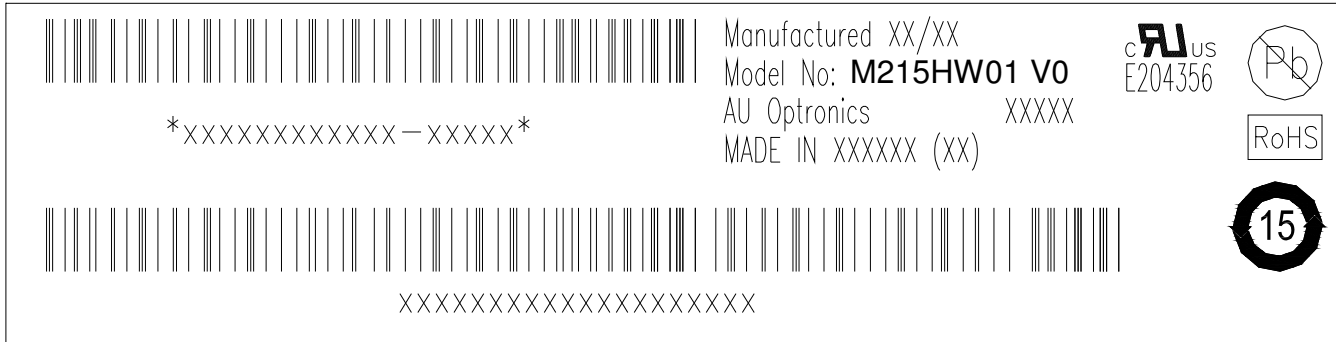

Note 1: For Pb Free products, AUO will add  for identification.

Note 2: For RoHS compatible products, AUO will add  for identification.

Note 3: For China RoHS compatible products, AUO will add  for identification.

Note 4: The Green Mark will be presented only when the green documents have been ready by AUO Internal Green Team.

10.0 Mechanical Characteristics

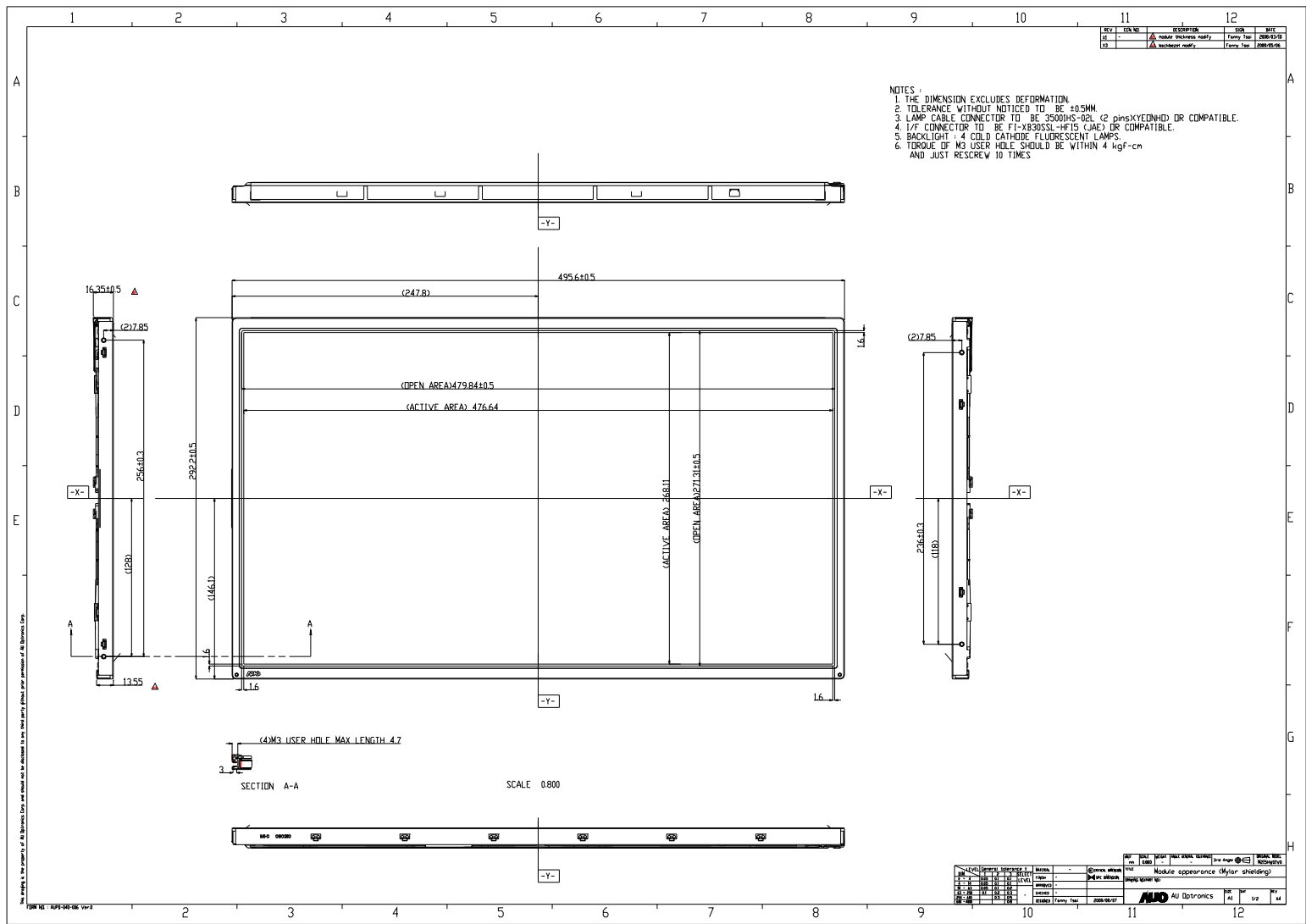

REV	REV NO	DESCRIPTION	DATE	BY
1	1	Initial release ready	2008-03-05	Yanyu Yao
2	1	Initial release ready	2008-03-05	Yanyu Yao

REV	REV NO	DESCRIPTION	DATE	BY
1	1	Initial release ready	2008-03-05	Yanyu Yao
2	1	Initial release ready	2008-03-05	Yanyu Yao

REV	DATE	DESCRIPTION	BY	CHK
01		Final assembly	Family Team	08/08/2011
02		Forming Test	Family Team	08/08/2011
03		Forming Test	Family Team	08/08/2011

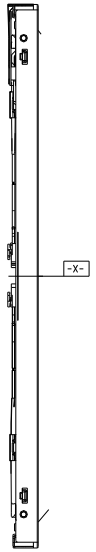
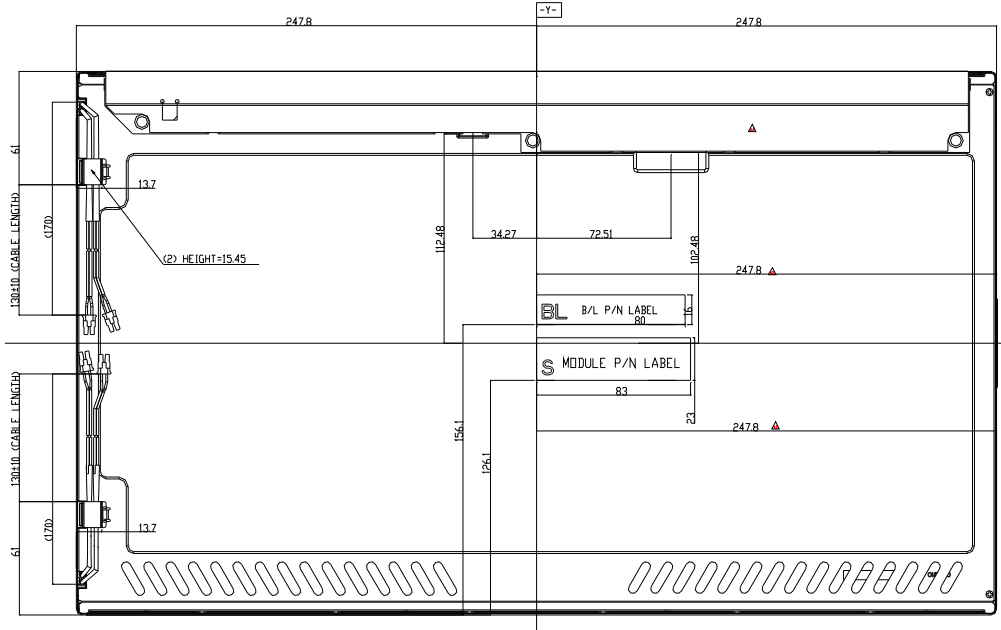

SCALE 1.000

All rights reserved by AU Optronics Corp. All dimensions are in millimeters unless otherwise specified. All dimensions are subject to change without notice.

REV	DATE	DESCRIPTION	BY	CHK
01		Final assembly	Family Team	08/08/2011
02		Forming Test	Family Team	08/08/2011
03		Forming Test	Family Team	08/08/2011