



Gleichmann & Co. Electronics GmbH
Product Marketing Displays & Systems
Industriestr. 16, D- 76297 Stutensee
Tel :07249-910-0, Fax: 07249-910-559
<http://www.msc-ge.com>

Product Specifications

20" WXGA Color TFT-LCD Module
Model Name: T200XW02

(*) Preliminary Specifications
() Final Specifications



Contents

No	ITEM
	COVER
	CONTENTS
	RECORD OF REVISIONS
1	GENERAL DESCRIPTION
2	ABSOLUTE MAXIMUM RATINGS
3	ELECTRICAL SPECIFICATIONS
3-1	ELECTRICAL CHARACTERISTICS
3-2	INTERFACE CONNECTIONS
3-3	SIGNAL TIMING SPECIFICATIONS
3-4	SIGNAL TIMING WAVEFORMS
3-5	COLOR INPUT DATA REFERENCE
3-6	POWER SEQUENCE
4	OPTICAL SPECIFICATIONS
5	MECHANICAL CHARACTERISTICS
6	INTERNATIONAL STANDARDS
6-1	SAFETY
6-2	EMC
7	PACKING
8	PRECAUTIONS



1. General Description

This specification applies to the 20.0 inch Color TFT-LCD Module T200XW02.

This module supports the WXGA (1366(H) x 768(V)) screen format and 16.2M colors (6-bits + FRC).

All input signals are 1 channel LVDS interface compatible.

This module is without any inverter card for backlight.

Features

- WXGA 1366(H) x 768(V) resolution
- Fast response Time (**8ms**)
- 50,000 hours lamp life
- 6 CCFL Side Light Design (Cold Cathode Fluorescent Lamp)
- High brightness, High contrast ratio
- Wide viewing angle
- Low power consumption
- Green Design (ROHS Compliance)
- HDTV Ready Module

Application

Personal TV

Multi-function media

Video Game Console



* General Information

The following items are characteristics summary on the table 25 °C condition:

Items	Specification	Unit	Note
Active Screen Size	20.04 inches		50.9cm diagonal
Display Area	443.61(H) x 249.41(V)	mm	
Outline Dimension	472.0(H) x 276.5(V) x 23.0(D) (typ.)	mm	Without inverter
Resolution	1366(R,G,Bx3) x 768	Pixels	
Pixel Pitch	0.32475 x 0.32475		
Pixel Arrangement	RGB vertical stripe		
Display mode	TN mode, Normally White		
Display Colors	16.2M (6-bit + FRC for R,G,B)	Colors	
Typical White Luminance	450 nit (typ.) @ 6.5mA	[cd/m ²]	
Contrast Ratio	600:1(typ.)		
Color Gamut	72%(typ.) of NTSC		
Response Time	8ms(typ.) (Tr+Tf)	ms	
Viewing Angle (L/R/U/D)	80/80/80/60		CR>10
Power Consumption	40.7 W (typ.)(VDD line +CCFL line)	W	@6.5mA
Electronic Interface	1ch LVDS		
Frame rate	60Hz(typ.), 75Hz(max.)	Hz	
Weight(g)	3000(max)	g	
Surface Treatment	Hard-Coating 3H, AG		
ROHS	ROHS compliance		



2. Absolute Maximum Ratings

The following are maximum values which, if exceeded, may cause faulty operation or damage to the unit.

Item	Symbol	Min	Max	Unit	Note
Logic/LCD Drive Voltage	V _{DD}	-0.3	6	[Volt]	1
Input Voltage of Signal	V _{IN}	-0.3	3.6	[Volt]	1
Operating Temperature	T _{OP}	0	+50	[°C]	2
Operating Humidity	H _{OP}	10	90	[%RH]	2
Storage Temperature	T _{ST}	-20	+60	[°C]	2
Storage Humidity	H _{ST}	10	90	[%RH]	2

Note 1 : Duration = 50msec

Note 2 : Maximum Wet-Bulb should be 39°C and No condensation.

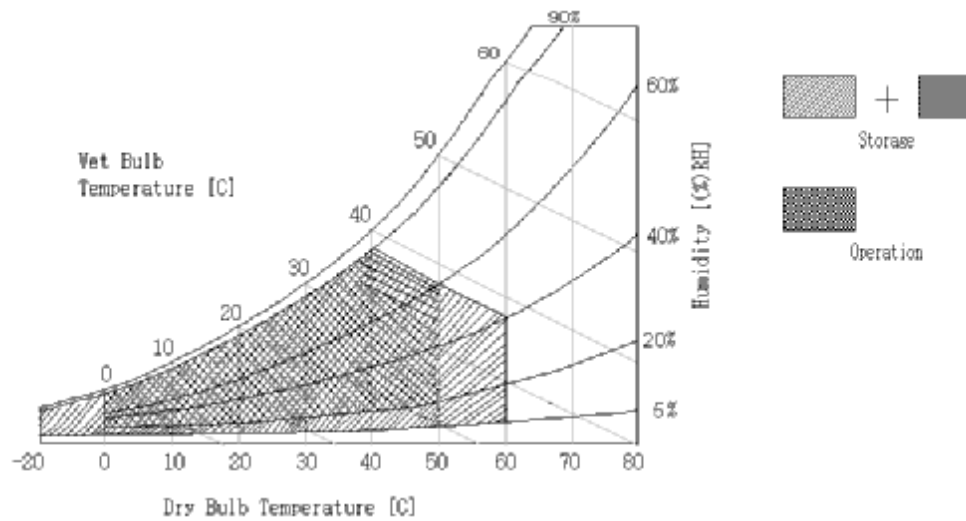



3. Electrical Specification

The T200XW02 requires two power inputs. One is employed to power the LCD electronics and to drive the TFT array and liquid crystal. An inverter typically generates the second input, which powers the CCFL.

3-1 Electrical Characteristics

Parameter	Symbol	Values			Unit	Notes
		Min	Typ	Max		
LCD:						
Power Supply Input Voltage	Vdd	4.5	5.0	5.5	Vdc	
Power Supply Input Current	Idd		0.7	TBD	A	1
Power Consumption	Pc		3.5	TBD	Watt	1
Inrush Current	I _{RUSH}		2.0	TBD	A	1
Backlight Power Consumption		-	37.2	-	Watt	2
TTL Power Consumption			40.7		Watt	2
Life Time		50000	-	-	Hours	3

The performance of the Lamp in LCM, for example lifetime or brightness, is extremely influenced by the characteristics of the DC-AC Inverter. So all the parameters of an inverter should be carefully designed so as not to produce too much leakage current from high-voltage output of the inverter. When you design or order the inverter, please make sure unwanted lighting caused by the mismatch of the lamp and the inverter (no lighting, flicker, etc) never occurs. When you confirm it, the LCD Assembly should be operated in the same condition as installed in your instrument.

Do not attach a conducting tape to lamp connecting wire. If the lamp wire attach to conducting tape, TFT-LCD Module have a low luminance and the inverter has abnormal action because leakage current occurs between lamp wire and conducting tape.

The relative humidity must not exceed 80% non-condensing at temperatures of 40°C or less. At temperatures greater than 40°C, the wet bulb temperature must not exceed 39°C. When operate at low temperatures, the brightness of CCFL will drop and the lifetime of CCFL will be reduced.

Note :

1. Vdd=5.0V, fv=75Hz, fclk=85 Mhz , 25°C, Vdd Duration time= 470 *ms*

The Power supply input check pattern definition and dissipation reference as below :

Horizontal 2 Dot pattern : TBD(Max.)

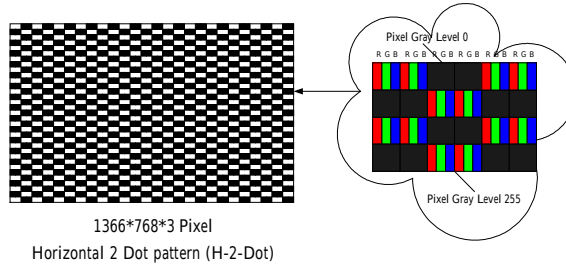

White pattern : TBD A

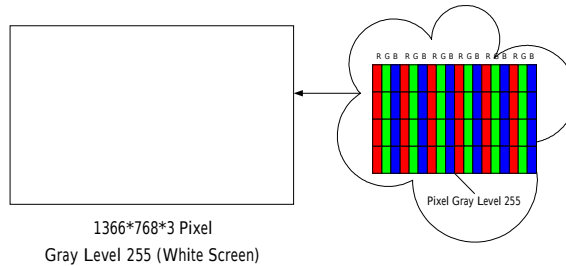

Black pattern : TBD A

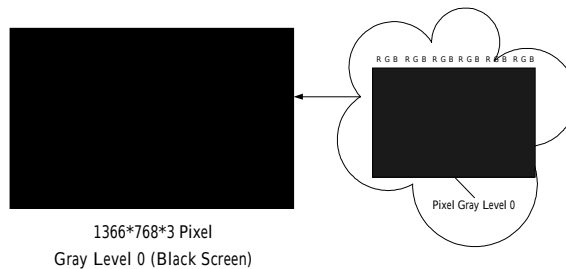

Vertical gray scale pattern : TBD A(Typ.)

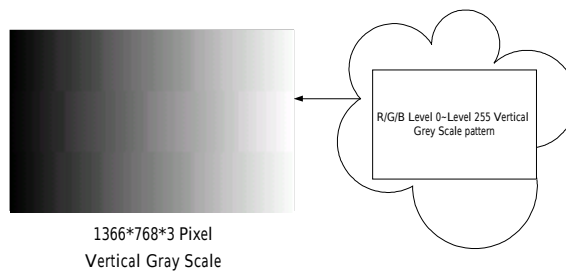

2. The lamp power consumption shown above does include loss of external inverter at 25°C. The used lamp current is the lamp typical current
3. The life is determined as the time at which luminance of the lamp is 50% compared to that of initial value at the typical lamp current on condition of continuous operating at 25±2°C. The lamp current should fix at 6.5mA(typ.) and then keep the 50000hr(typ.) lamp life



3-2 Interface Connections

- LCD connector (CN1): JAE FI-X30SSL-HF or equivalent
- LVDS Transmitter: SN75LVDS83 (Texas Instruments) or equivalent

Note:

1. All GND (ground) pins should be connected together and should also be connected to the LCD's metal frame. All Vcc (power input) pins should be connected together.

No	Description	No	Description
1	N.C.	16	GND
2	N.C.	17	Rx3-
3	N.C.	18	Rx3+
4	GND	19	GND
5	Rx0-	20	N.C.
6	Rx0+	21	LVDS Option*
7	GND	22	N.C.
8	Rx1-	23	GND
9	Rx1+	24	GND
10	GND	25	GND
11	Rx2-	26	Vdd (+5V)
12	Rx2+	27	Vdd (+5V)
13	GND	28	Vdd (+5V)
14	RxCLK-	29	Vdd (+5V)
15	RxCLK+	30	Vdd (+5V)

LVDS Option : H (3.3V) or NC ⇒ NS (Default)

L (GND) ⇒ JETDA



Backlight Connector Pin Configuration

Electrical specification (Lamp spec)

Parameter	Min	Typ	Max	Units	Condition
CCFL current(ICFL)		6.5		[mA] rms	(Ta=25°C)
CCFL Frequency(FCFL)		40		[KHz]	(Ta=25°C)
CCFL Ignition Voltage(Vs)		TBD		[Volt] rms	(Ta= 0°C)
CCFL Voltage (Reference) (VCFL)		920		[Volt] rms	(Ta=25°C)
CCFL Power consumption (PCFL)		37.2		[Watt]	(Ta=25°C)

Lamp connect configuration

Mating connector: SM02B-BHS-1-TB (JST)



SM02B

(pin1)

Connector mating way:

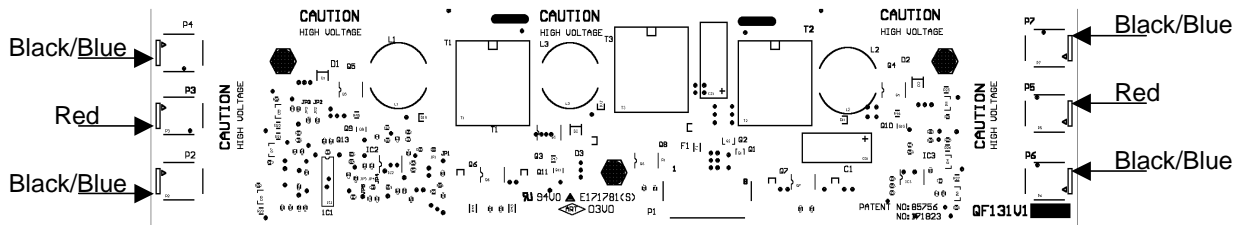



3-3 Signal Timing Specifications

This is the signal timing required at the input of the User connector. All of the interface signal timing should be satisfied with the following specifications for its proper operation.

* Timing Table

Item	Symbol	Min.	Typ.	Max.	Unit
DCLK	Period	Tc	12.84	11.76	ns
	Freq.	fc	77.9	85	MHz
Hsync	Freq.	1/Th	48.5		KHz
Vsync	Freq.	1/Yv	60		Hz
Vertical	Period	Tv	808		Th
	Active	Tvd	768		Th
Horizontal	Period	Th	1606		DCLK
	Active	Thd	1366		DCLK

*1) DCLK signal input must be valid while power supply is applied.

*2) Display position is specific by the rise of ENAB signal only.

Horizontal display position is specified by the falling edge of 1st DCLK right after the rise of ENAB, is displayed on the left edge of the screen.

Vertical display position is specified by the rise of ENAB after a "Low" level period equivalent to eight times of horizontal period. The 1st data corresponding to one horizontal line after the rise the of ENAB is displayed at the top line of screen.

3.) If a period of ENAB "High" is less than 1366 DCLK or less than 768 lines, the rest of the screen displays black.

4.) The display position does not fit to the screen if a period of ENAB "High" and the effective data period do not synchronize with each other.



3-4 Signal Timing Waveforms

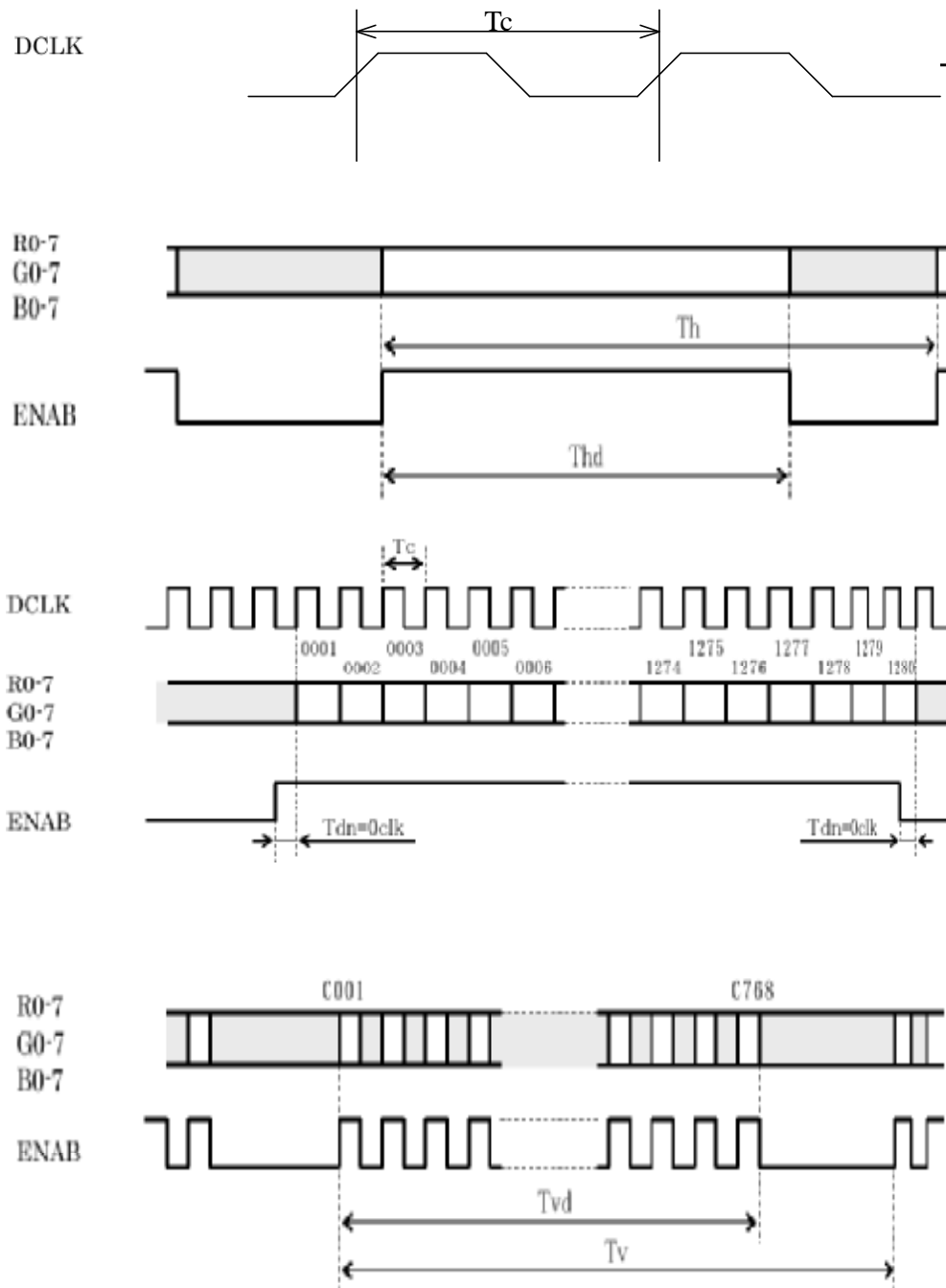



3-5 Color Input Data Reference

The brightness of each primary color (red, green and blue) is based on the 8 bit gray scale data input for the color; the higher the binary input, the brighter the color. The table below provides a reference for color versus data input.

COLOR DATA REFERENCE

Color		Input Color Data																							
		RED								GREEN								BLUE							
		MSB								MSB								MSB							
		LSB								LSB								LSB							
		R7	R6	R5	R4	R3	R2	R1	R0	G7	G6	G5	G4	G3	G2	G1	G0	B7	B6	B5	B4	B3	B2	B1	B0
Basic Color	Black	0	0	0	0	0	0	0	0	0	0	0	0	0	0	0	0	0	0	0	0	0	0	0	0
	Red(255)	1	1	1	1	1	1	1	1	0	0	0	0	0	0	0	0	0	0	0	0	0	0	0	0
	Green(255)	0	0	0	0	0	0	0	0	1	1	1	1	1	1	1	1	0	0	0	0	0	0	0	0
	Blue(255)	0	0	0	0	0	0	0	0	0	0	0	0	0	0	0	0	1	1	1	1	1	1	1	1
	Cyan	0	0	0	0	0	0	0	0	1	1	1	1	1	1	1	1	1	1	1	1	1	1	1	1
	Magenta	1	1	1	1	1	1	1	1	0	0	0	0	0	0	0	0	1	1	1	1	1	1	1	1
	Yellow	1	1	1	1	1	1	1	1	1	1	1	1	1	1	1	1	0	0	0	0	0	0	0	0
	White	1	1	1	1	1	1	1	1	1	1	1	1	1	1	1	1	1	1	1	1	1	1	1	1
RED	RED(000)	0	0	0	0	0	0	0	0	0	0	0	0	0	0	0	0	0	0	0	0	0	0	0	0
	RED(001)	0	0	0	0	0	0	0	1	0	0	0	0	0	0	0	0	0	0	0	0	0	0	0	0

	RED(254)	1	1	1	1	1	1	1	0	0	0	0	0	0	0	0	0	0	0	0	0	0	0	0	0
	RED(255)	1	1	1	1	1	1	1	1	0	0	0	0	0	0	0	0	0	0	0	0	0	0	0	0
GREEN	GREEN(000)	0	0	0	0	0	0	0	0	0	0	0	0	0	0	0	0	0	0	0	0	0	0	0	0
	GREEN(001)	0	0	0	0	0	0	0	0	0	0	0	0	0	0	1	0	0	0	0	0	0	0	0	0

	GREEN(254)	0	0	0	0	0	0	0	0	1	1	1	1	1	1	1	0	0	0	0	0	0	0	0	0
	GREEN(255)	0	0	0	0	0	0	0	0	1	1	1	1	1	1	1	1	0	0	0	0	0	0	0	0
BLUE	BLUE(000)	0	0	0	0	0	0	0	0	0	0	0	0	0	0	0	0	0	0	0	0	0	0	0	0
	BLUE(001)	0	0	0	0	0	0	0	0	0	0	0	0	0	0	0	0	0	0	0	0	0	0	0	1

	BLUE(254)	0	0	0	0	0	0	0	0	0	0	0	0	0	0	0	0	1	1	1	1	1	1	1	0
	BLUE(255)	0	0	0	0	0	0	0	0	0	0	0	0	0	0	0	0	1	1	1	1	1	1	1	1



3-6 Power Sequence

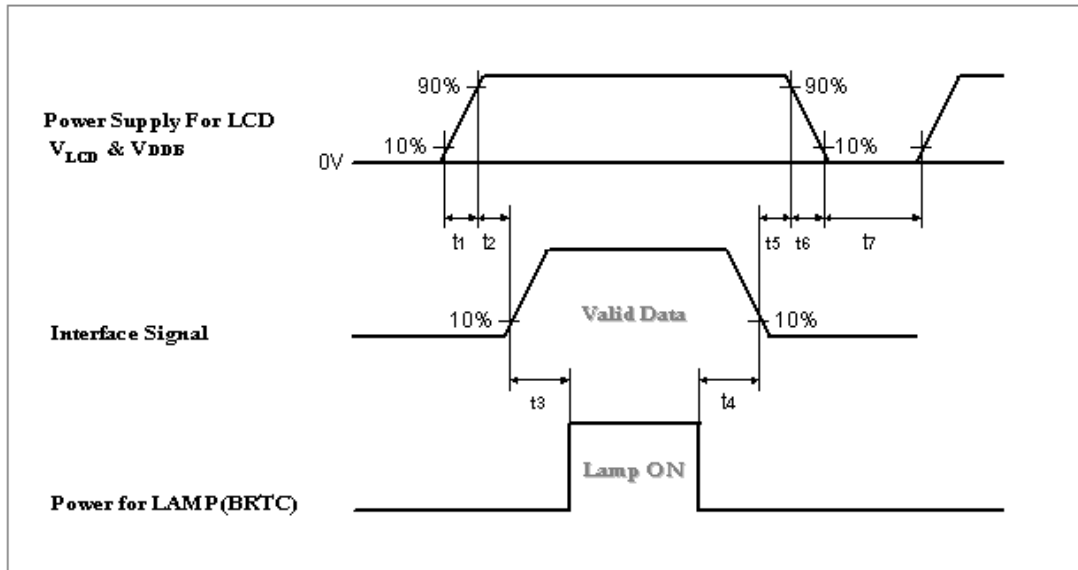

Parameter	Values			Units
	Min.	Typ.	Max.	
t1	470		1000	us
t2	25		150	ms
t3	650			ms
t4	200			ms
t5	50			ms
t6	0.47		30	ms
t7	1			s

Apply the lamp voltage within the LCD operating range. When the backlight turns on before the LCD operation or the LCD turns off before the backlight turns off, the display may momentarily become abnormal.

Caution : The above on/off sequence should be applied to avoid abnormal function in the display. In case of handling, make sure to turn off the power when you plug the cable into the input connector or pull the cable out of the connector.

4. Optical Specification

Optical characteristics are determined after the unit has been 'ON' and stable for approximately 30 minutes in a dark environment at 25°C. The values specified are at an approximate distance 50cm from the LCD surface at a viewing angle of Φ and θ equal to 0°.

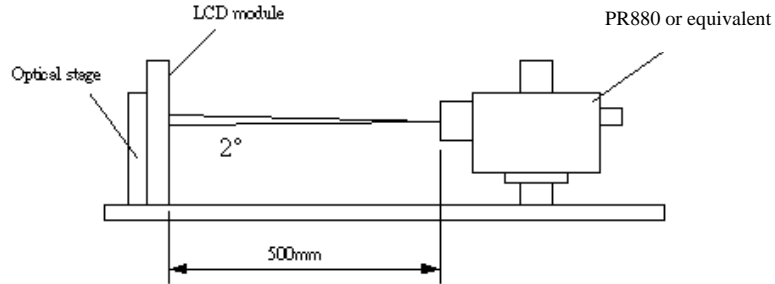

Fig.4-1 Optical measurement equipment and method

Parameter	Symbol	Values			Units	Notes
		Min.	Typ.	Max.		
Contrast Ratio	CR	500	600			1
Surface Luminance, white	LWH	350	450		cd/m ²	2
Luminance Variation	δ_{WHITE}	5 p		1.25		3
Response Time	T_{γ}		8		ms	4,5 (Ton+Toff)
	Rise Time	T_r	TBD	TBD	ms	
	Decay Time	T_f	TBD	TBD	ms	
Color Coordinates						
	RED	R_x		TBD		
		R_y		TBD		
	GREEN	G_x		TBD		
		G_y		TBD		
	BLUE	B_x	Typ.-0.03	TBD	Typ.+0.03	
		B_y		TBD		
	WHITE	W_x		TBD		
		W_y		TBD		
Viewing Angle						
	x axis, right($\varphi=0^\circ$)	θ_r	TBD	80	Degree	6
	x axis, left($\varphi=180^\circ$)	θ_l	TBD	80		
	y axis, up($\varphi=90^\circ$)	θ_u	TBD	80		
	y axis, down($\varphi=0^\circ$)	θ_d	TBD	60		

Note:

1. Contrast Ratio (CR) is defined mathematically as:

$$\text{Contrast ratio (CR)} = \frac{\text{Brightness on the "white" state}}{\text{Brightness on the "black" state}}$$

2. Surface luminance is luminance value at point 1 across the LCD surface 50cm from the surface with all pixels displaying white. From more information see FIG 4-2. When $I_{BL} = 4.5\text{mA}$, $L_{WH} = 450\text{cd/m}^2$ (typ.) $L_{WH} = L_{on1}$, Where L_{on1} is the luminance with all pixels displaying white at center 1 location.

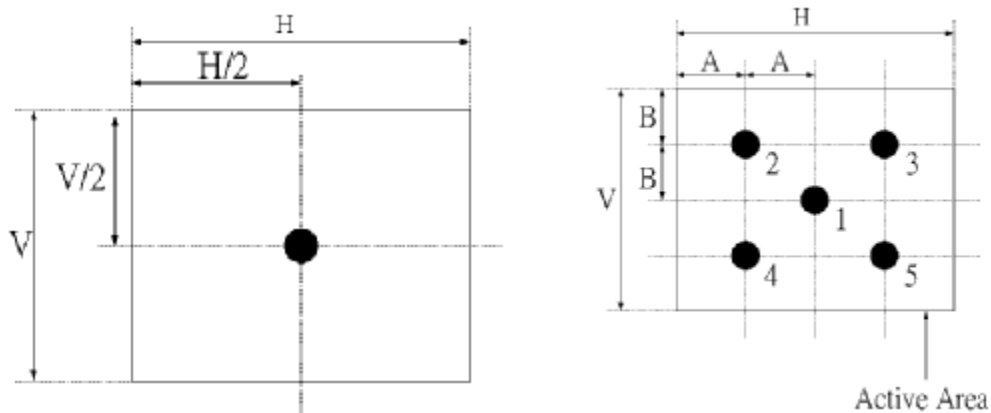

Fig.4-2 Optical measurement point

3. The variation in surface luminance, δ WHITE is defined (center of Screen) as:

$$\delta_{\text{WHITE}(5P)} = \frac{\text{Maximum}(L_{on1}, L_{on2}, \dots, L_{on5})}{\text{Minimum}(L_{on1}, L_{on2}, \dots, L_{on5})}$$

4. Response time is the time required for the display to transition from white(L255) to black(L0) (Decay Time, $T_{rD} = T_f$) and from black(L0) to white(L255) (Rise Time, $T_{rR} = T_r$). For additional information see FIG4-3.

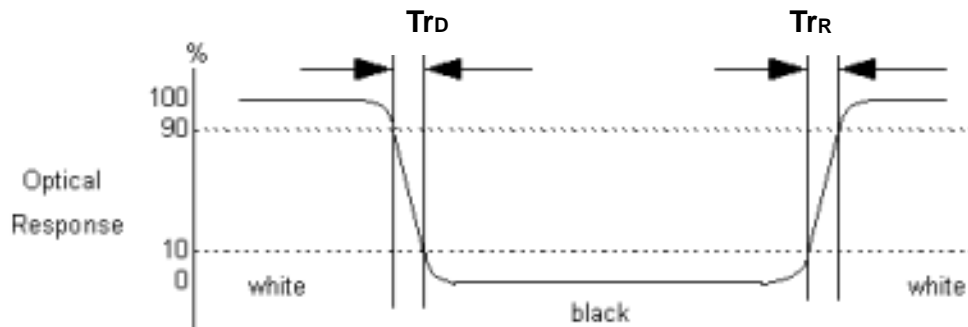

Fig.4-3 Response time

5. The response time is defined as the following figure and shall be measured by switching the input signal for different gray level. For additional information see FIG4-4

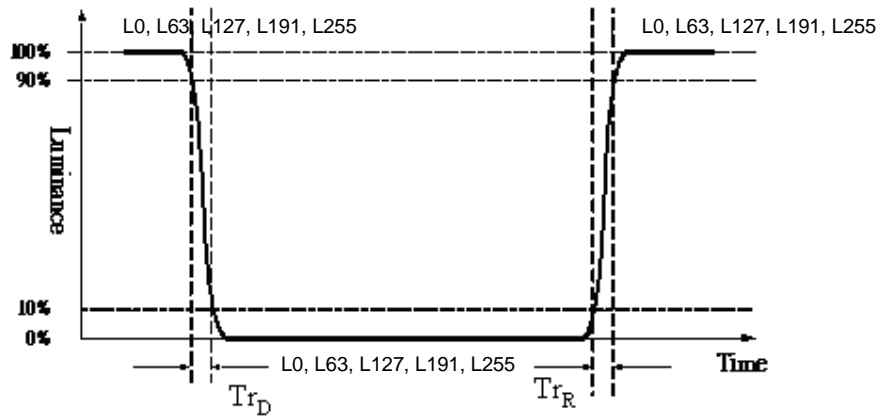

Fig.4-4 Response time

6. Viewing angle is the angle at which the contrast ratio is greater than 10. The angles are determined for the horizontal or x axis and the vertical or y axis with respect to the z axis which is normal to the LCD surface. For more information see FIG4-5.

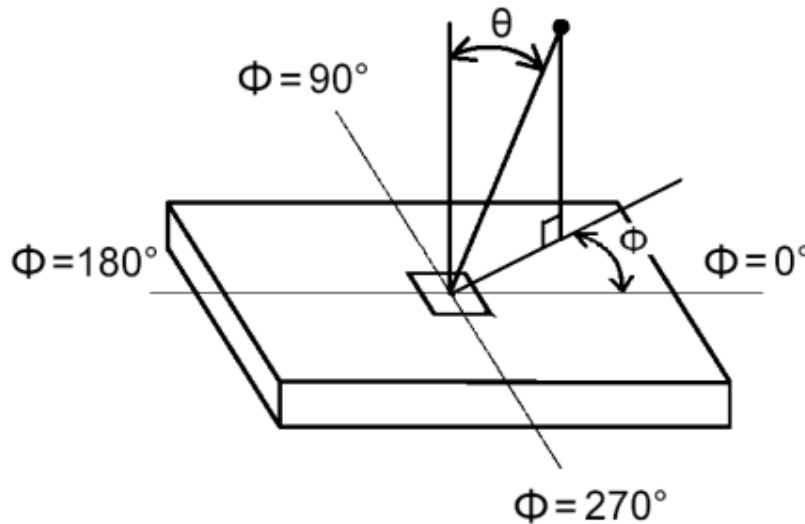

Fig.4-5 Viewing Angle Definition



5. Mechanical Characteristics

The contents provide general mechanical characteristics for the model T200XW02. In addition the figures in the next page are detailed mechanical drawing of the LCD.

Outline Dimension	Horizontal (typ.)	472.0mm
	Vertical (typ.)	276.5mm
	Depth (typ.)	23.0mm
Bezel Area	Horizontal (typ.)	448.0mm
	Vertical (typ.)	253.8mm
Active Display Area	Horizontal	443.61mm
	Vertical	249.41mm
Weight	3000g (max.)	
Surface Treatment	HC, 3H	



6. International Standard

6-1. Safety

- (1) UL6500, Underwriters Laboratories, Inc. (AUO file number : E204356)
Standard for Safety of Information Technology Equipment Including electrical Business Equipment.
- (2) CAN/CSA C22.2 No. 950-95 Third Edition, Canadian Standards Association, Jan. 28, 1995
Standard for Safety of Information Technology Equipment Including Electrical Business Equipment.
- (3) EN60950 : 1992+A2: 1993+A2: 1993+C3: 1995+A4: 1997+A11: 1997
IEC 950: 1991+A1: 1992+A2: 1993+C3: 1995+A4:1996
IEC 60065
European Committee for Electro technical Standardization (CENELEC)
EUROPEAN STANDARD for Safety of Information Technology Equipment Including Electrical Business Equipment.

6-2. EMC

- a) ANSI C63.4 "Methods of Measurement of Radio-Noise Emissions from Low-Voltage Electrical and Electrical Equipment in the Range of 9kHz to 40GHz. "American National standards Institute(ANSI), 1992
- b) C.I.S.P.R "Limits and Methods of Measurement of Radio Interface Characteristics of Information Technology Equipment." International Special committee on Radio Interference.
- c) EN 55022 "Limits and Methods of Measurement of Radio Interface Characteristics of Information Technology Equipment." European Committee for Electrotechnical Standardization. (CENELEC), 1998



7. Packing

Label Sample



Green Mark Description:

For Pb Free products, AUO will add  for identification.

For RoHS compatible products, AUO will add  for identification.

Note. The Green Mark will be present only when the green documents have been ready by AUO Internal Green Team. (The definition of green design follows the AUO green design checklist.)

Carton Label

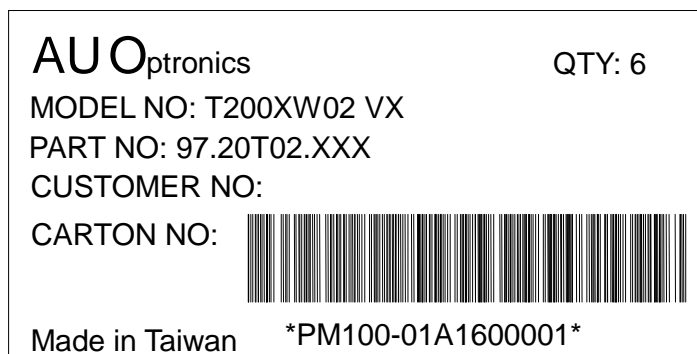

Cushion set

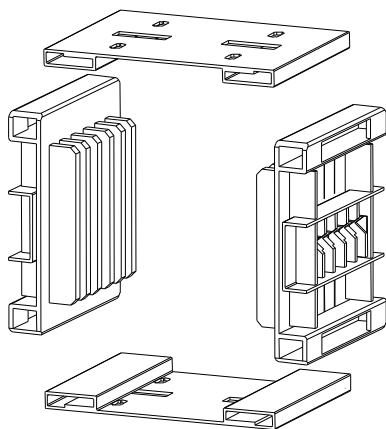

Carton Box, 320mm(W)x590mm(L)x410mm(H)



Pallet Package

©Copyright AU Optronics, Inc.
November, 2005 All Rights Reserved.
No Reproduction and Redistribution Allowed

T200XW02 Ver0.2

22/25



Air Cargo : (3 *2) *3 layers, total 18 boxes with 108 pcs panel in one pallet

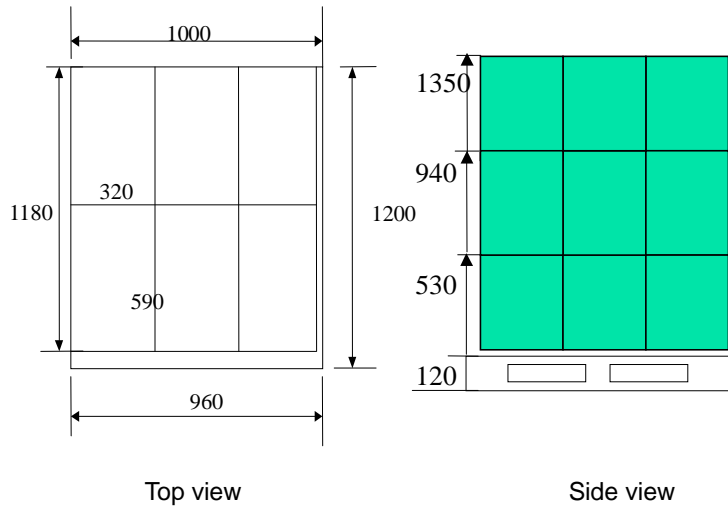

Ocean shipping : (3 *2) *5layers, total 30 boxes with 180 pcs panel in one pallet

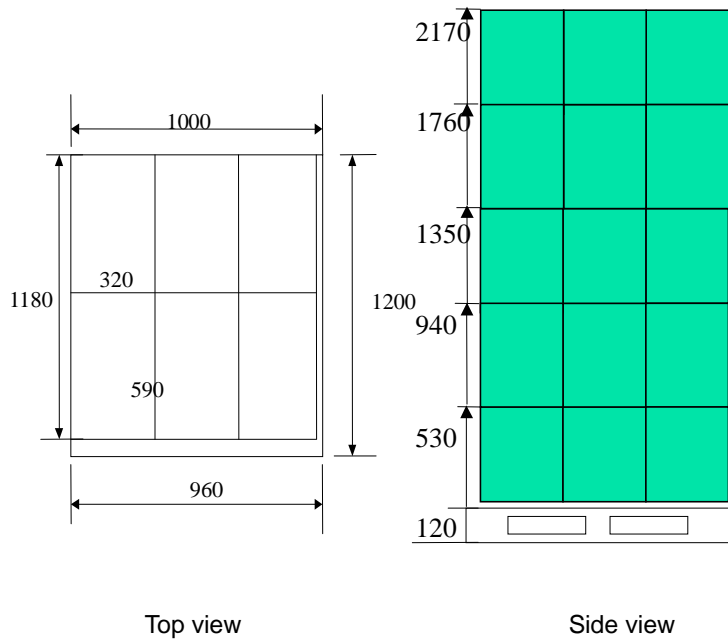



8. PRECAUTIONS

Please pay attention to the followings when you use this TFT LCD module.

8-1 MOUNTING PRECAUTIONS

- (1) You must mount a module using holes arranged in four corners or four sides.
- (2) You should consider the mounting structure so that uneven force (ex. Twisted stress) is not applied to module. And the case on which a module is mounted should have sufficient strength so that external force is not transmitted directly to the module.
- (3) Please attach the surface transparent protective plate to the surface in order to protect the polarizer. Transparent protective plate should have sufficient strength in order to resist external force.
- (4) You should adopt radiation structure to satisfy the temperature specification.
- (5) Acetic acid type and chlorine type materials for the cover case are not desirable because the former generates corrosive gas of attacking the polarizer at high temperature and the latter causes circuit break by electro-chemical reaction.
- (6) Do not touch, push or rub the exposed polarizers with glass, tweezers or anything harder than HB pencil lead. And please do not rub with dust clothes with chemical treatment. Do not touch the surface of polarizer for bare hand or greasy cloth. (Some cosmetics are detrimental to the polarizer.)
- (7) When the surface becomes dusty, please wipe gently with absorbent cotton or other soft materials like chamois soaks with petroleum benzene. Normal-hexane is recommended for cleaning the adhesives used to attach front/ rear polarizers. Do not use acetone, toluene and alcohol because they cause chemical damage to the polarizer.
- (8) Wipe off saliva or water drops as soon as possible. Their long time contact with polarizer causes deformations and color fading.
- (9) Do not open the case because inside circuits do not have sufficient strength.

8-2 OPERATING PRECAUTIONS

- (1) The spike noise causes the mis-operation of circuits. It should be lower than following voltage: $V=\pm 200\text{mV}$ (Over and under shoot voltage)
- (2) Response time depends on the temperature. (In lower temperature, it becomes longer..)
- (3) Brightness depends on the temperature. (In lower temperature, it becomes lower.) And in lower temperature, response time (required time that brightness is stable after turned on) becomes longer.



- (4) Be careful for condensation at sudden temperature change. Condensation makes damage to polarizer or electrical contacted parts. And after fading condensation, smear or spot will occur.
- (5) When fixed patterns are displayed for a long time, remnant image is likely to occur.
- (6) Module has high frequency circuits. Sufficient suppression to the electromagnetic interference shall be done by system manufacturers. Grounding and shielding methods may be important to minimize the interface.

8-3 ELECTROSTATIC DISCHARGE CONTROL

Since a module is composed of electronic circuits, it is not strong to electrostatic discharge. Make certain that treatment persons are connected to ground through wrist band etc. And don't touch interface pin directly.

8-4 PRECAUTIONS FOR STRONG LIGHT EXPOSURE

Strong light exposure causes degradation of polarizer and color filter.

8-5 STORAGE

When storing modules as spares for a long time, the following precautions are necessary.

- (1) Store them in a dark place. Do not expose the module to sunlight or fluorescent light. Keep the temperature between 5°C and 35°C at normal humidity.
- (2) The polarizer surface should not come in contact with any other object. It is recommended that they be stored in the container in which they were shipped.

8-6 HANDLING PRECAUTIONS FOR PROTECTION FILM

- (1) The protection film is attached to the bezel with a small masking tape. When the protection film is peeled off, static electricity is generated between the film and polarizer. This should be peeled off slowly and carefully by people who are electrically grounded and with well ion-blown equipment or in such a condition, etc.
- (2) When the module with protection film attached is stored for a long time, sometimes there remains a very small amount of glue still on the Bezel after the protection film is peeled off.
- (3) You can remove the glue easily. When the glue remains on the Bezel or its vestige is recognized, please wipe them off with absorbent cotton waste or other soft material like chamois soaked with normal-hexane.