

$V_{RRM}$	=	400 V
$I_{FAVM}$	=	9244 A
$I_{FRMS}$	=	14520 A
$I_{FSM}$	=	60000 A
$V_{F0}$	=	0.780 V
$r_F$	=	0.031 mW

## Housingless Welding Diode

# 5SDD 92Z0400

## PRELIMINARY

Doc. No. 5SYA1178-00 March 07

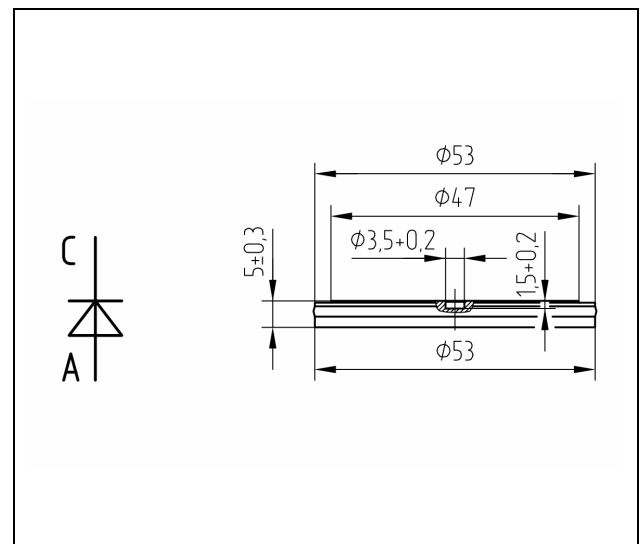
- High forward current capability
- Low forward and reverse recovery losses
- High current application up to 2000 Hz
- For parallel connection, please contact factory

### Blocking

$V_{RRM}$	Repetitive peak reverse voltage	400 V	Half sine waveform, $f = 50$ Hz $T_j = -40 \dots 180$ °C
$I_{RRM}$	Repetitive peak reverse current	50 mA	$V_R = V_{RRM}$

### Mechanical

$F_M$	Mounting force	22 ..50 kN
$m$	Weight	0.10 kg
$D_S$	Surface creepage distance	2 mm
$D_a$	Air strike distance	2 mm



**Fig. 1**

Outline drawing.

All dimensions are in millimeters and represent nominal values unless stated otherwise.

ABB Switzerland Ltd, Semiconductors reserves the right to change specifications without notice.

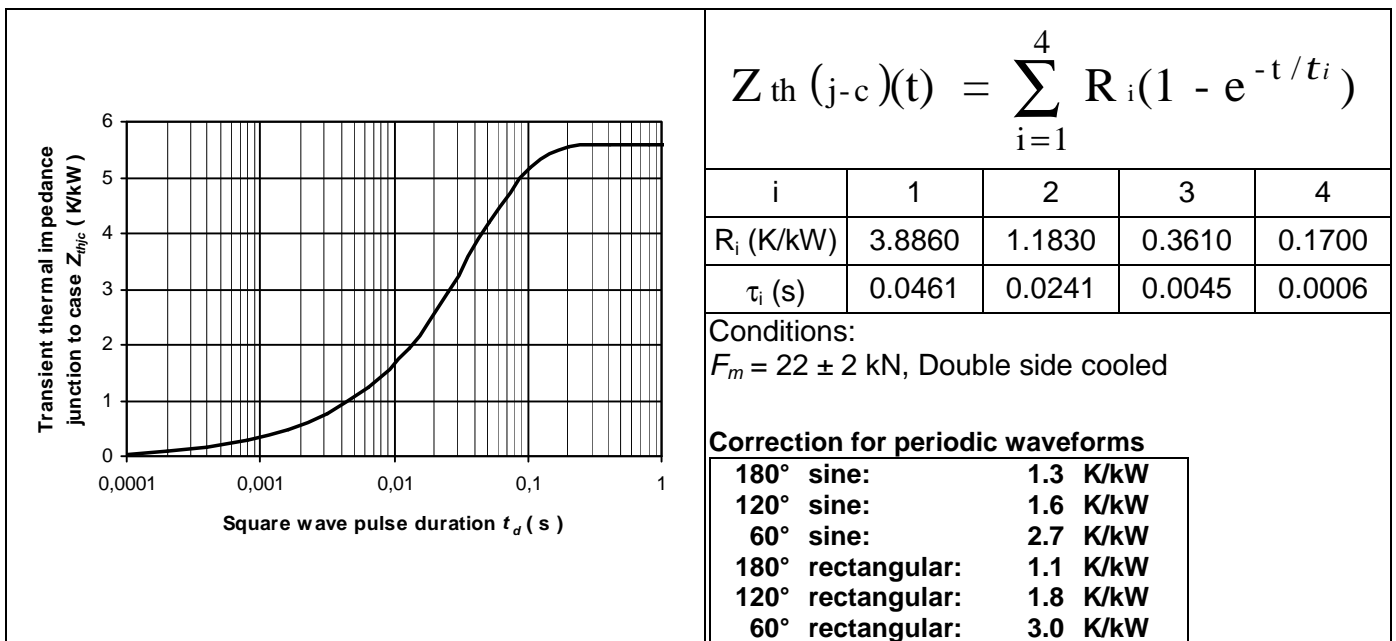
## On-state

$I_{FAVM}$	Max. average on-state current	9244 A	$T_c = 85\text{ °C}$	Half sine pulse
$I_{FRMS}$	Max. RMS on-state current	14520 A	$T_c = 85\text{ °C}$	Half sine pulse
$I_{FSM}$	Max. peak non-repetitive surge current	64000 A	$t_p = 8.3\text{ ms}$	$V_R = 0\text{ V}$
		60000 A	$t_p = 10\text{ ms}$	Half sine pulse
$\int i^2 dt$	Max. surge current integral	17049 kA <sup>2</sup> s	$t_p = 8.3\text{ ms}$	$V_R = 0\text{ V}$
		18000 kA <sup>2</sup> s	$t_p = 10\text{ ms}$	Half sine pulse
$V_{Fmax}$	Max. on-state voltage	0.920 V	$I_F = 5000\text{ A}$	
		1.030 V	$I_F = 8000\text{ A}$	
$V_{F0}$	Max. Threshold voltage	0.780 V		
$r_F$	Max. Slope resistance	0.031 mΩ	$I_F = 7\ 000...21\ 000\text{ A}$	
$Q_{rr}$	Typ. Recovered charge	400 μC	$I_F = 1\ 000\text{ A}$ , $di/dt = -30\text{ A}/\mu\text{s}$ , $V_R = 100\text{ V}$	

Unless otherwise specified  $T_j = 180\text{ °C}$

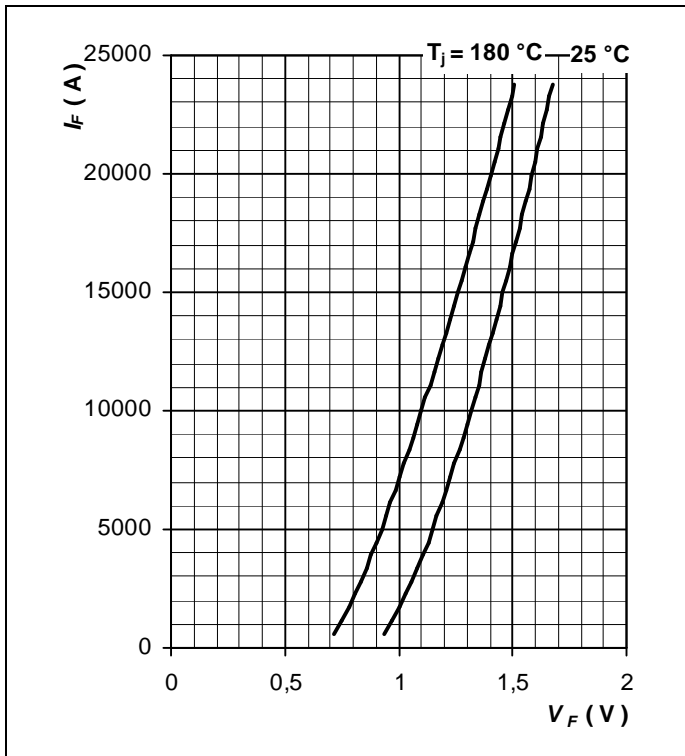
## Thermal characteristics

$T_j$	Operating junction temperature range	-40...180 °C	
$T_{stg}$	Storage temperature range	-40...180 °C	
$R_{th(j-c)}$	Thermal resistance junction to case	7.4 K/kW	Anode side cooled
		23.5 K/kW	Cathode side cooled
		5.6 K/kW	Double side cooled
$R_{th(c-h)}$	Thermal resistance case to heatsink	6.7 K/kW	Anode side cooled
		8.0 K/kW	Cathode side cooled
		3.6 K/kW	Double side cooled



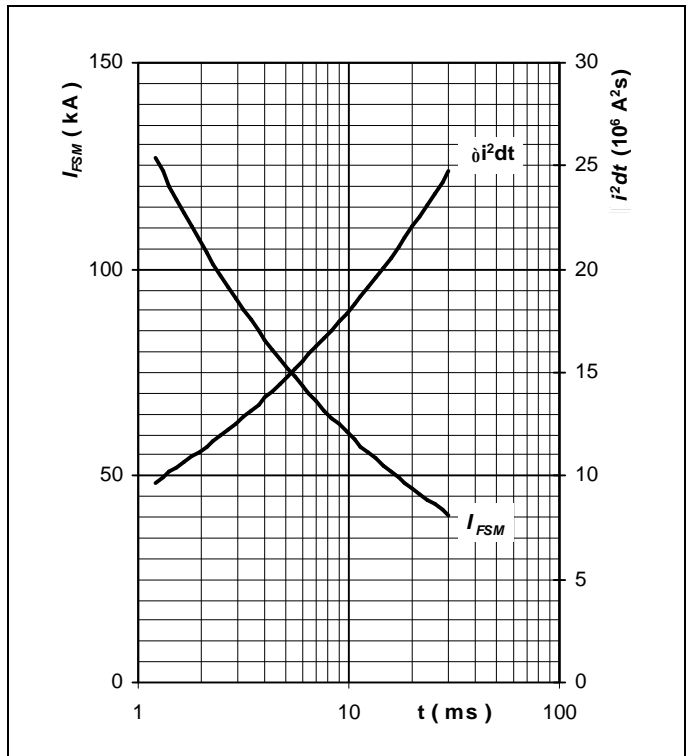
**Fig. 2** Transient thermal impedance (junction-to-case) vs. time in analytical and graphical forms.

**On-state characteristics**



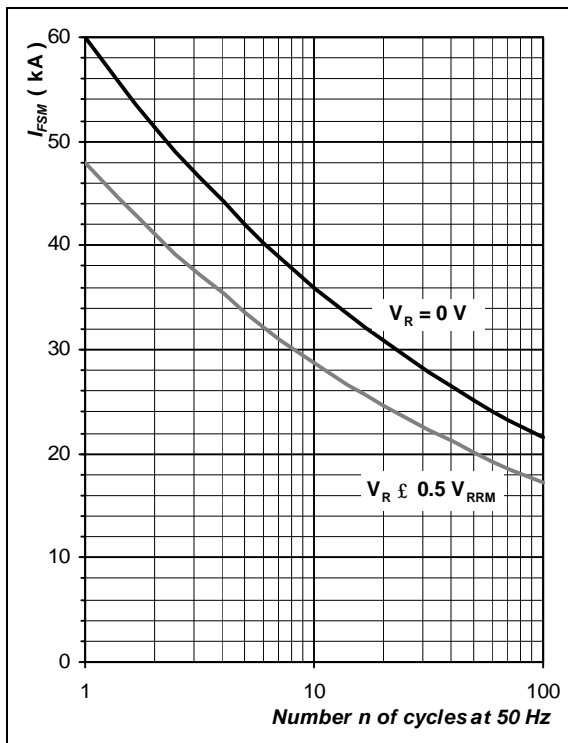
**Fig. 3** Forward current vs. forward voltage (max. values).

**Surge current characteristics**



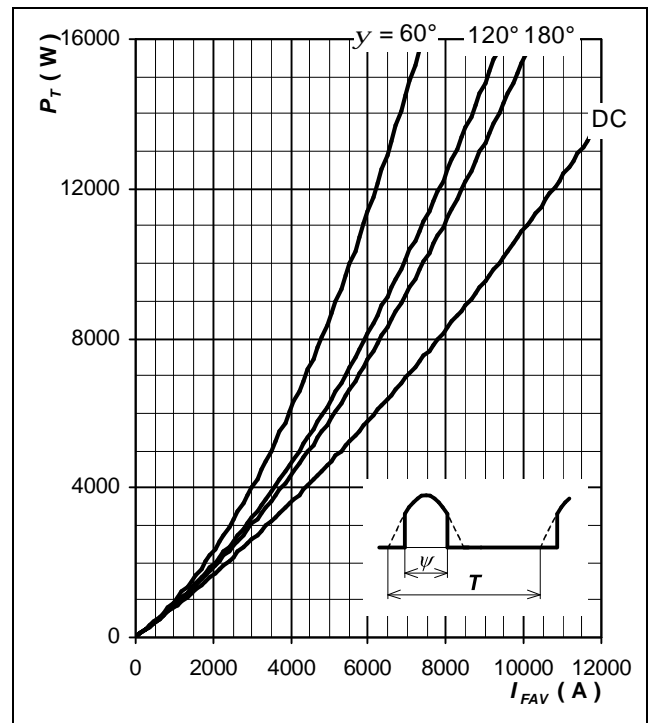
**Fig. 4** Surge forward current vs. pulse length, half sine wave, single pulse,  $V_R = 0 \text{ V}$ ,  $T_j = T_{jmax}$

**Surge current characteristics**



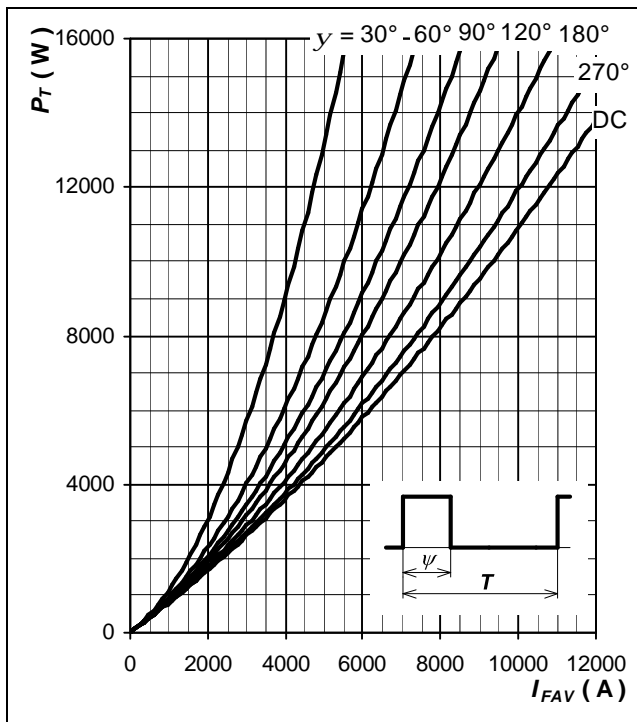
**Fig. 5** Surge forward current vs. number of pulses, half sine wave,  $T_j = T_{jmax}$

**Forward power loss**

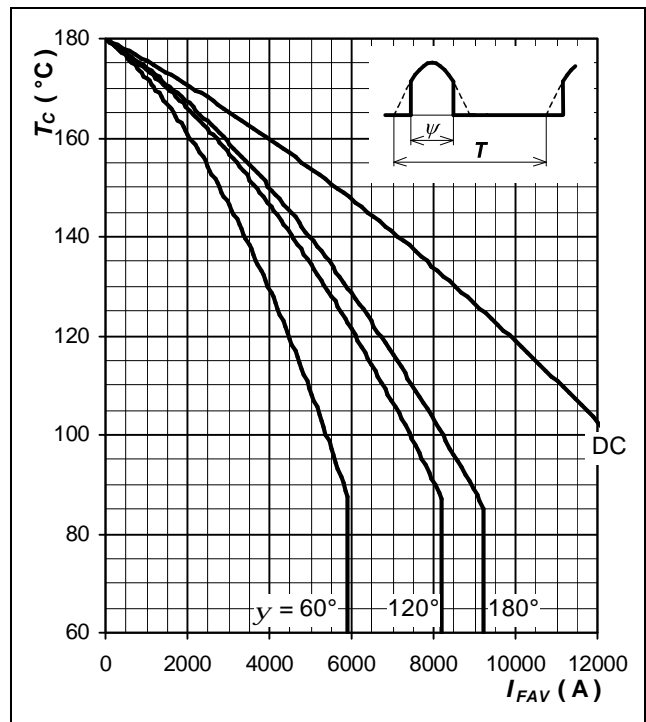


**Fig. 6** Forward power loss vs. average forward current, sine waveform,  $f = 50 \text{ Hz}$ ,  $T = 1/f$

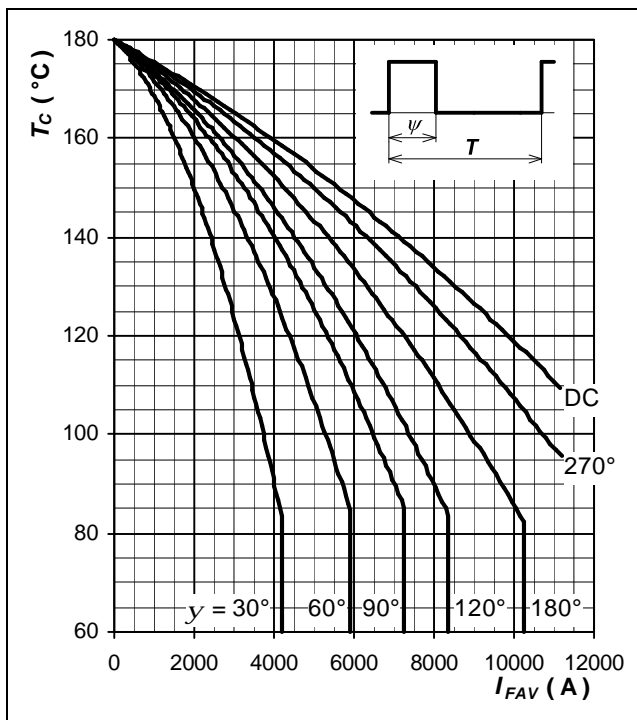
**Forward power loss**



**Fig. 7** Forward power loss vs. average forward current, square waveform,  $f = 50 \text{ Hz}$ ,  $T = 1/f$



**Fig. 8** Forward power loss vs. average forward current, sine waveform,  $f = 50 \text{ Hz}$ ,  $T = 1/f$



**Fig. 9** Max. case temperature vs. aver. forward current, square waveform,  $f = 50 \text{ Hz}$ ,  $T = 1/f$

ABB Switzerland Ltd, Semiconductors reserves the right to change specifications without notice.



ABB Switzerland Ltd  
Semiconductors  
Fabrikstrasse 3  
CH-5600 Lenzburg, Switzerland

Doc. No. 5SYA1178-00 March 07

Telephone +41 (0)58 586 1419  
Fax +41 (0)58 586 1306  
Email [abbsem@ch.abb.com](mailto:abbsem@ch.abb.com)  
Internet [www.abb.com/semiconductors](http://www.abb.com/semiconductors)