

## GMPSA27 NPN SILICON DARLINGTON TRANSISTOR

### Description

The GMPSA27 is designed for darlington applications requiring extremely high current gain at collector to 500mA.

### Package Dimensions

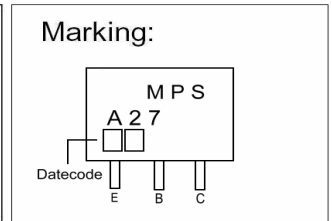
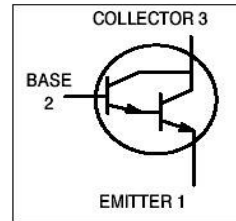
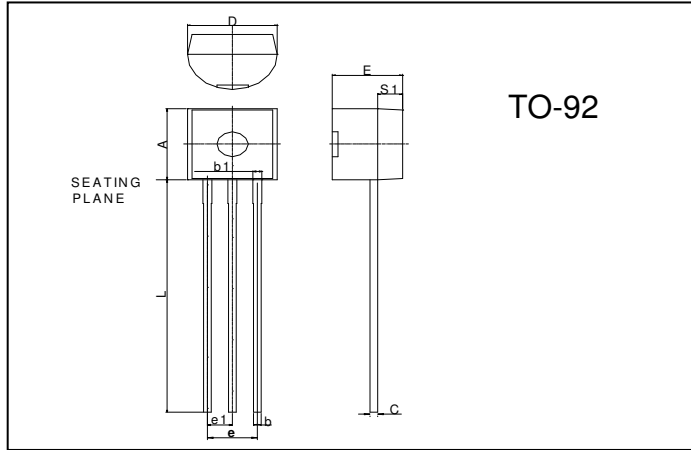

REF.	Millimeter		REF.	Millimeter	
	Min.	Max.		Min.	Max.
A	4.45	4.7	D	4.44	4.7
S1	1.02	-	E	3.30	3.81
b	0.36	0.51	L	12.70	-
b1	0.36	0.76	e1	1.150	1.390
C	0.36	0.51	e	2.42	2.66

### Absolute Maximum Ratings at Ta = 25°C

Parameter	Symbol	Ratings	Unit
Junction Temperature	Tj	+150	°C
Storage Temperature	Tstg	-55 ~ +150	°C
Collector to Base Voltage	VCBO	60	V
Collector to Emitter Voltage	VCES	60	V
Emitter to Base Voltage	VEBO	10	V
Collector Current	Ic	500	mA
Total Power Dissipation	PD	625	mW

### Characteristics at Ta = 25°C

Symbol	Min.	Typ.	Max.	Unit	Test Conditions
BVCBO	60	-	-	V	Ic=100uA, IE=0
BVCES	60	-	-	V	Ic=100uA, VBE=0
BVEBO	10	-	-	V	IE=10uA, Ic=0
ICBO	-	-	100	nA	VCB=50V, IE = 0
ICES	-	-	500	nA	VCE=50V
IEBO	-	-	100	nA	VEB=10V, Ic = 0
*VCE(sat)	-	-	1.5	V	Ic=100mA, Ib=0.1mA
VBE(on)	-	-	2	V	VCE=5V, Ic=100mA
*hFE1	10K	-	-		VCE=5V, Ic=10mA
*hFE2	10K	-	-		VCE=5V, Ic=100mA

● Pulse Test: Pulse Width ≤ 380us, Duty Cycle ≤ 2%

## Characteristics Curve

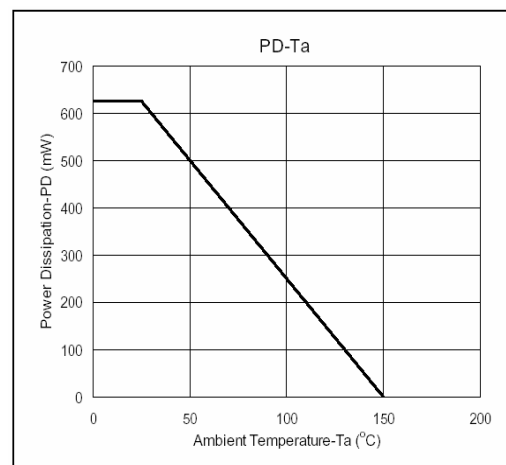
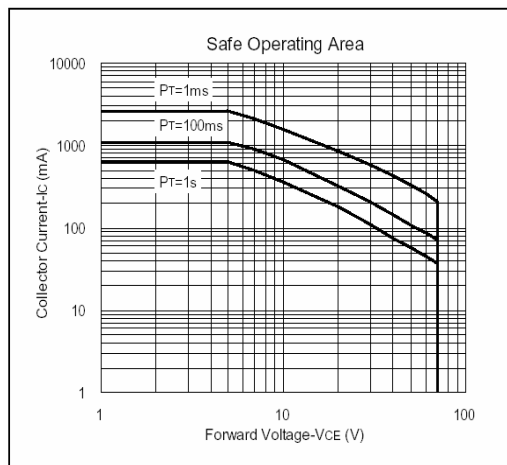
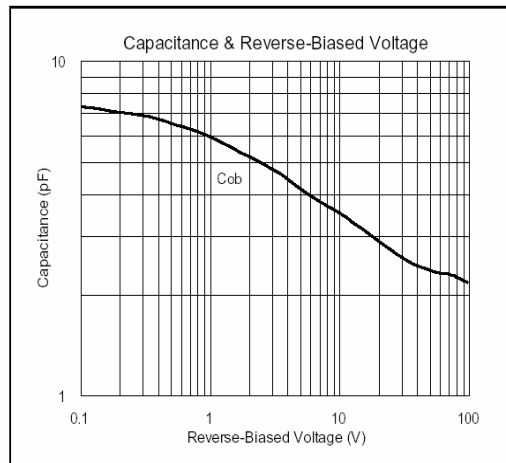
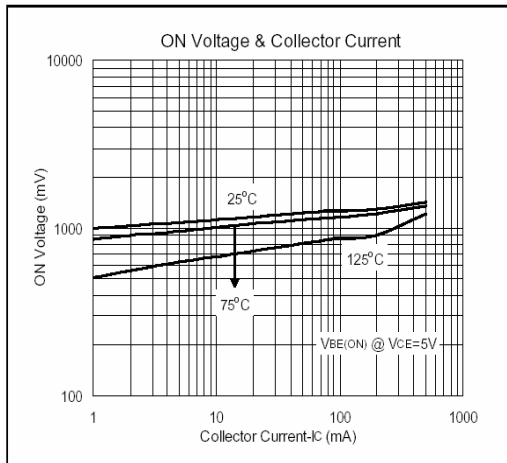
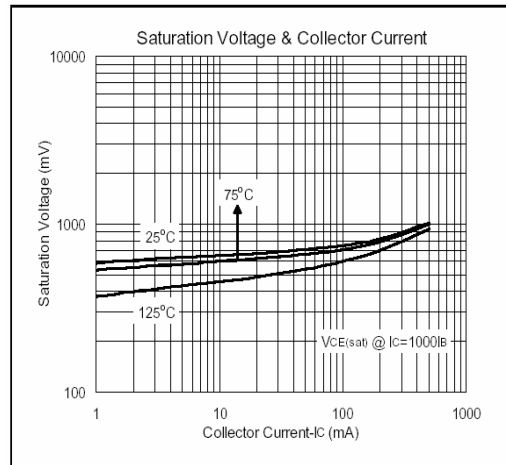
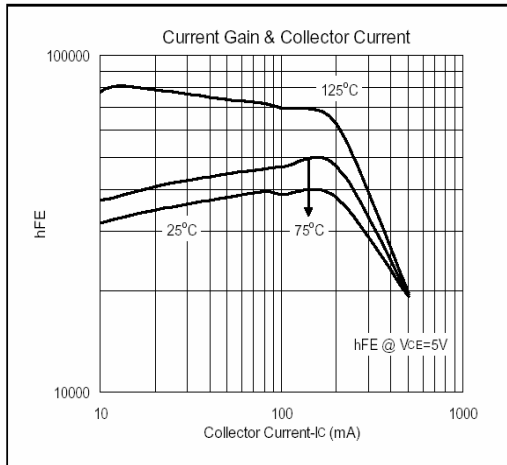

**Important Notice:**

- All rights are reserved. Reproduction in whole or in part is prohibited without the prior written approval of GTM.
- GTM reserves the right to make changes to its products without notice.
- GTM semiconductor products are not warranted to be suitable for use in life-support Applications, or systems.
- GTM assumes no liability for any consequence of customer product design, infringement of patents, or application assistance.

**Head Office And Factory:**

- **Taiwan:** No. 17-1 Tatung Rd. Fu Kou Hsin-Chu Industrial Park, Hsin-Chu, Taiwan, R. O. C.
- TEL : 886-3-597-7061 FAX : 886-3-597-9220, 597-0785
- **China:** (201203) No.255, Jang-Jiang Tsai-Lueng RD. , Pu-Dung-Hsin District, Shang-Hai City, China
- TEL : 86-21-5895-7671 ~ 4 FAX : 86-21-38950165