

VI TELEFILTER

Filter specification

TFS 350D

Measurement condition

Ambient Temperature: 23 °C
 Input Power Level: 0 dBm
 Terminating Impedance at f_C^* :
 input: 47 Ω // 7,2 pF
 output: 47 Ω // 7,5 pF

Characteristics

Remark:

The reference level for the relative attenuation a_{rel} of TFS 350D is the minimum of the pass band attenuation a_{min} . This minimum is defined as the insertion loss a_e . The nominal frequency f_N is fixed at 350 MHz without any tolerance. The given values for the relative attenuation a_{rel} and the group delay ripple have to be reached at the frequencies given below, even if the centre frequency f_C is shifted due to the temperature coefficient of frequency TC_f in the operating temperature range and due to a production tolerance for the centre frequency f_C .

D a t a		typ. Value	Limit
Insertion Loss (Reference Level)	$a_e = a_{min}$	16 dB	max. 20,0 dB
Nominal Frequency	f_N	-	350,0 MHz
Pass Band Amplitude Ripple within PB	PB	-	$f_N \pm 0,75$ MHz max. 0,5 dB p-p
Group Delay Variation within PB		110 ns	max. 180 ns
Return loss in PB		10 dB	-
Relative Attenuation	a_{rel}		
f_N ... $f_N \pm 0,75$ MHz		0,5 dB	max. 0,7 dB
$f_N \pm 4,45$ MHz ... $f_N \pm 30$ MHz		48 dB	min. 40 dB
$f_N \pm 30$ MHz ... $f_N \pm 350$ MHz		53 dB	min. 50 dB
Operating Temperature Range		-	-40... +85 °C
Storage Temperature Range		-	-55... +85 °C
Turnover temperature T_0		30 °C	-
Temperature Coefficient of frequency TC_f^{**}		- 0,036 ppm / K ²	-

*) The terminating impedances depend on parasitics and q-values of matching elements and the board used, and are to be understood as reference values only. Should there be additional questions, do not hesitate to ask for an application note or contact our design team.

***) $\Delta f(\text{Hz}) = TC_f(\text{ppm/K}^2) \times (T - T_0)^2 \times f_{T0}(\text{MHz})$

generated: _____

checked / approved: _____

Tele Filter GmbH
 Potsdamer Straße 18
 D 14 513 TELTOW / Germany
 Tel: (+49) 3328 4784-0 / Fax: (+49) 3328 4784-30
 E-Mail: tft@telefilter.com

VI TELEFILTER reserves the right to make changes to the product(s) and/or information contained herein without notice. No liability is assumed as a result of their use or application. No rights under any patent accompany the sale of any such product(s) or information.

Filter characteristic

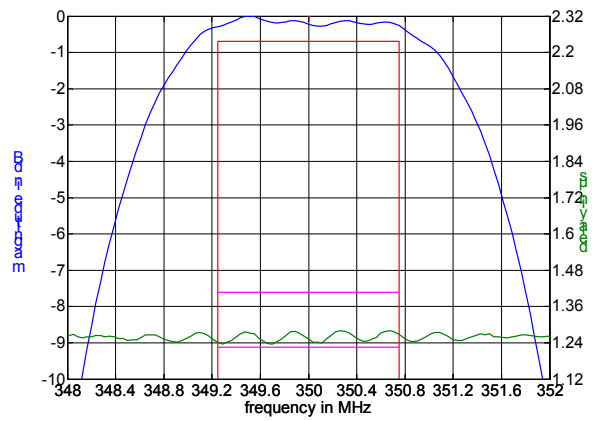
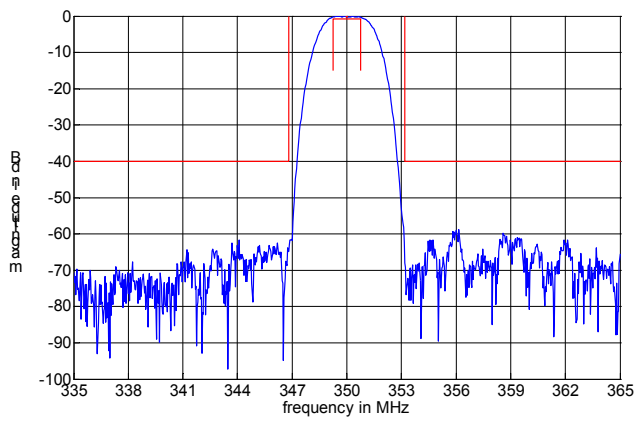

Construction and pin connection

(All dimensions in mm)

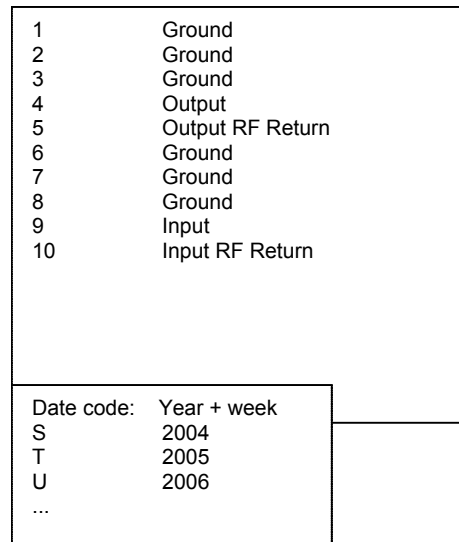
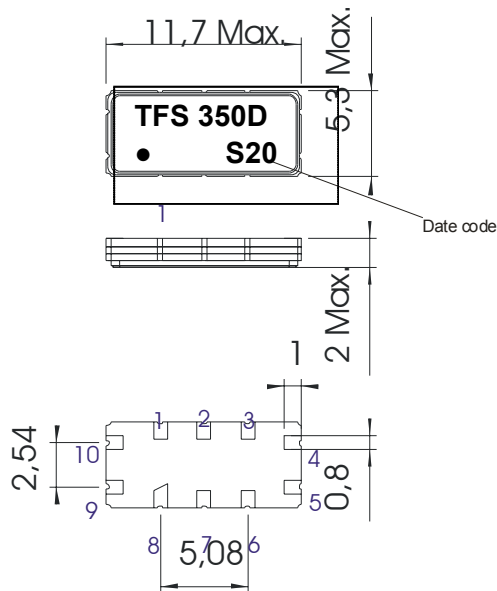

50 Ω Test circuit

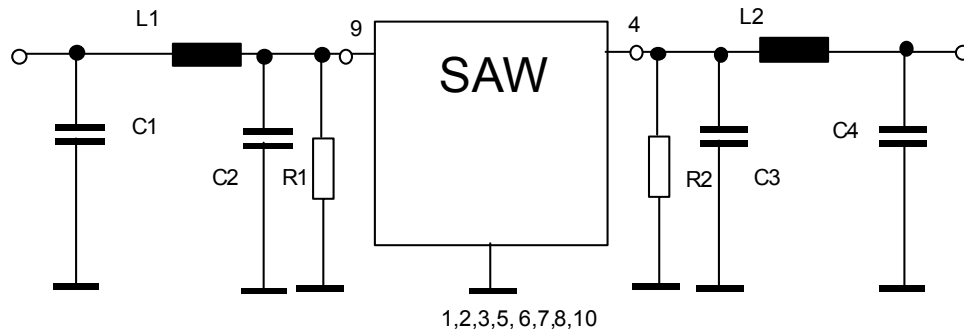

Tele Filter GmbH
 Potsdamer Straße 18
 D 14 513 TELTOW / Germany
 Tel: (+49) 3328 4784-0 / Fax: (+49) 3328 4784-30
 E-Mail: tft@telefilter.com

VI TELEFILTER reserves the right to make changes to the product(s) and/or information contained herein without notice. No liability is assumed as a result of their use or application. No rights under any patent accompany the sale of any such product(s) or information.

Stability Characteristics

After the following tests the filter shall meet the whole specification:

1. Shock: 500g, 18 ms, half sine wave, 3 shocks each plane;
DIN IEC 68 T2 - 27
2. Vibration: 10 Hz to 500 Hz, 0,35 mm or 5g respectively, 1 octave per min, 10 cycles per plan, 3 plans;
DIN IEC 68 T2 - 6
3. Change of temperature: -55 °C to 125°C / 30 min. each / 10 cycles
DIN IEC 68 part 2 – 14 Test N
4. Resistance to solder heat (reflow): reflow possible: twice max.;
for temperature conditions, please refer to the attached "Air reflow temperature conditions" on page 4;

Packing

Tape & Reel: DIN IEC 286 – 3, with exception of value for N and minimum bending radius;
tape type II, embossed carrier tape with top cover tape on the upper side;

max. pieces of filters per reel: 3000
reel of empty components at start: min 300 mm
reel of empty components at start including leader: min 500 mm
trailer: min 300 mm

Tape (all dimensions in mm)

- W : 24± 0,3
- Po : 4 ± 0,1
- Do : 1,5 + 0,1
- E : 1,75 ± 0,1
- F : 7,5 ± 0,1
- G (min) : 0,6
- P2 : 2 ± 0,1
- P1 : 8 ± 0,1
- D1(min) : 1,5
- Ao : 5,6 ± 0,1
- Bo : 11,8 ± 0,1
- CT : 21,5 ± 0,1

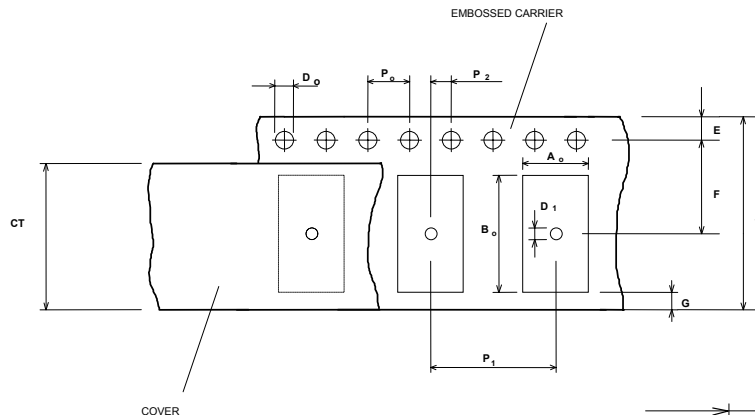

Reel (all dimensions in mm):

- A : 330
- W1 : 24,4 +2
- W2 (max) : 30,4
- N (min) : 60
- C : 13 +0,5/-0,2

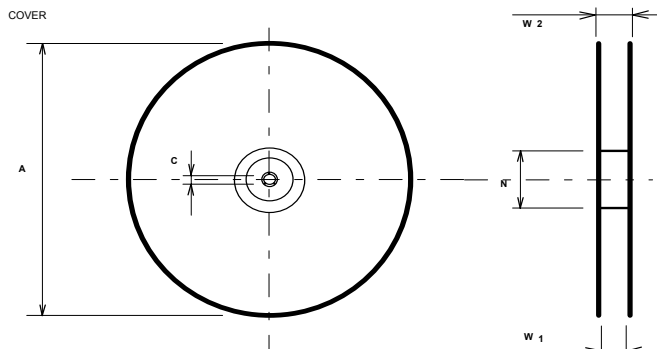

The minimum bending radius is 45 mm. The mounting surface of the filters faces the bottom side of the embossed carrier tape. Markings on the filters can be read if the upper side of the carrier tape is regarded with the sprocket holes on its right.

Tele Filter GmbH
Potsdamer Straße 18
D 14 513 TELTOW / Germany
Tel: (+49) 3328 4784-0 / Fax: (+49) 3328 4784-30
E-Mail: tft@telefilter.com

VI TELEFILTER reserves the right to make changes to the product(s) and/or information contained herein without notice. No liability is assumed as a result of their use or application. No rights under any patent accompany the sale of any such product(s) or information.

Air reflow temperature conditions

1st and 2nd air reflow profile

Name:	pre-heating periods	main-heating periods	peak temperature
Temperature:	150 °C – 170 °C	over 200 °C	255 °C ± 5 °C
Time:	60 sec. – 90 sec.	20 sec. – 25 sec.	

Chip-mount air reflow profile

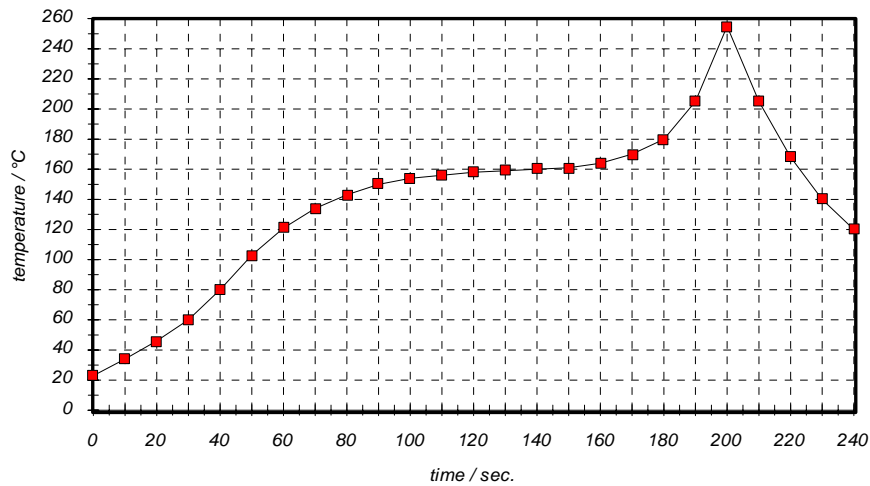

Table for temperature vs. Time during the air reflow process

Tolerance of temperatures: ± 5 °C

time / sec.	Temperature / °C	time / sec.	Temperature / °C
0	23	140	160
10	34	150	161
20	46	160	164
30	60	170	170
40	80	180	180
50	103	190	205
60	121	195	230
70	134	200	255
80	143	205	230
90	150	210	205
100	154	215	180
110	156	220	165
120	158	230	140
130	159	240	120

VI TELEFILTER**Filter specification****TFS 350D****5/5****History**

Version	Reason of Changes	Name	Date
1.0	generation of specification according to customer requirements	Pfeiffer	28.01.2002
1.1	typical value for return loss and extended storage temperature range added	Steiner	11.02.2002
1.2	typical values added terminating impedance added changing pinning 'output rf return'	Pfeiffer	24.05.2002
1.3	package (pin 1 marker) modified filter characteristic added	Pfeiffer	13.05.2004

Tele Filter GmbH
Potsdamer Straße 18
D 14 513 TELTOW / Germany
Tel: (+49) 3328 4784-0 / Fax: (+49) 3328 4784-30
E-Mail: tft@telefilter.com

VI TELEFILTER reserves the right to make changes to the product(s) and/or information contained herein without notice. No liability is assumed as a result of their use or application. No rights under any patent accompany the sale of any such product(s) or information.