



LIGITEK ELECTRONICS CO.,LTD.
Property of Ligitek Only

PLCC TYPE RED LED



Lead-Free Parts

L3URF9Q53S/TR1

DATA SHEET

DOC. NO : QW0905-L3URF9Q53S/TR1

REV. : A

DATE : 29 - Sep. - 2009





Package Dimensions

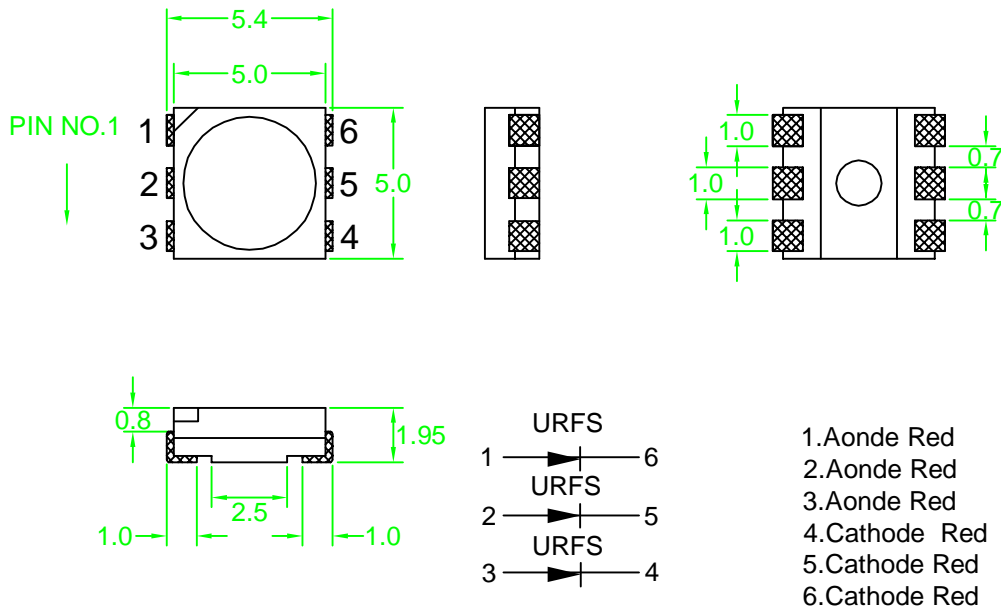

Note : 1.All dimension are in millimeter tolerance is $\pm 0.2\text{mm}$ unless otherwise noted.
 2.Specifications are subject to change without notice.

Carrier Type Dimensions

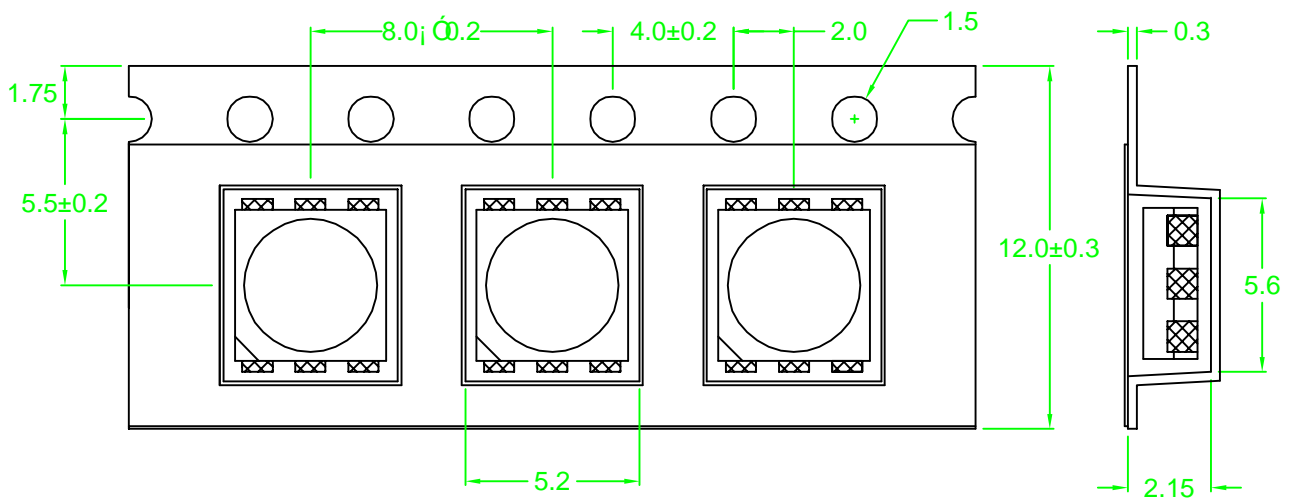

Note : The tolerances unless mentioned is $\pm 0.1\text{mm}$, Angle ± 0.5 . Unit=mm.



Reel Dimensions

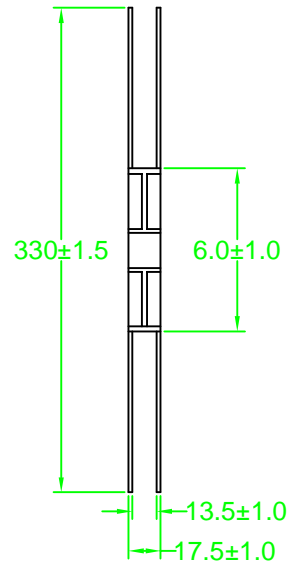
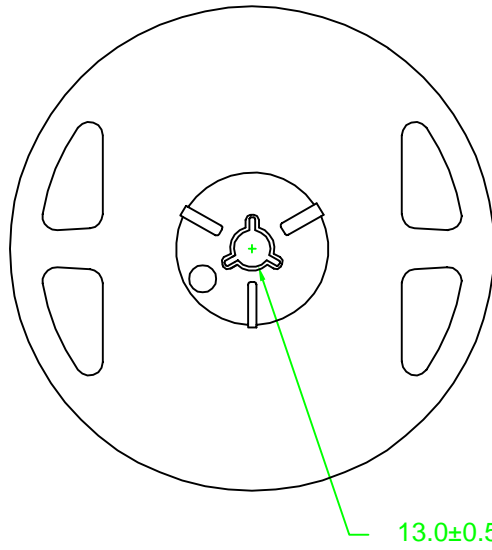

Part No.	Description	Quantity/Reel
L3URF9Q53S/TR1	12.0mm tape,13"reel	4000 devices

**Absolute Maximum Ratings at Ta=25**

Parameter	Symbol	Ratings	UNIT
		URF(S)	
Forward Current	IF	50	mA
Peak Forward Current Duty 1/10@10KHz	IFP	90	mA
Power Dissipation	PD	120	mW
Reverse Current @5V	Ir	10	μ A
Electrostatic Discharge(*)	ESD	2000	V
Operating Temperature	Topr	-40 ~ +85	
Storage Temperature	Tstg	-40 ~ +100	

* Static Electricity or power surge will damage the LED. Use of a conductive wrist band or anti-electrosatic glove is recommended when handing these LED. All devices, equipment and machinery must be properly grounded.

Typical Electrical & Optical Characteristics (Ta=25)

PART NO	MATERIAL	COLOR		Dominant wave length Dnm	Spectral halfwidth nm	Forward voltage @20mA(V)		Luminous intensity @20mA(mcd)		Viewing angle 2 1/2 (deg)
		Emitted	Lens			Min.	Max.	Min.	Typ.	
L3URF9Q53S/TR1	AlGaInP	Red	Water Clear	625	20	1.7	2.6	320	500	120

Note : 1.The forward voltage data did not including $\pm 0.1V$ testing tolerance.
2. The luminous intensity data did not including $\pm 15\%$ testing tolerance.



Typical Electro-Optical Characteristics Curve

URFS CHIP

Fig.1 Forward current vs. Forward Voltage

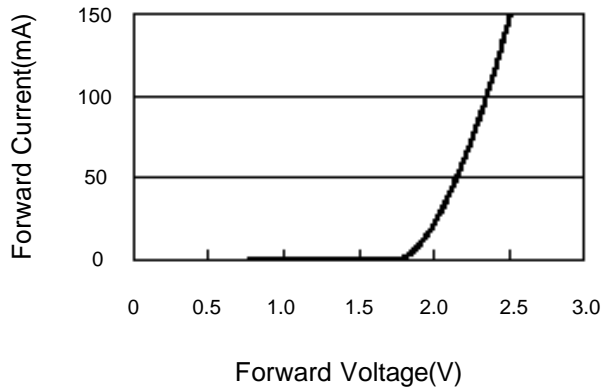

Fig.2 Luminous Intensity vs. Forward Current

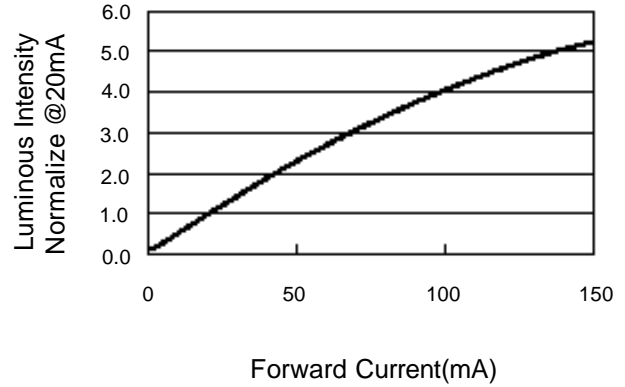

Fig.3 Forward Voltage vs. Temperature

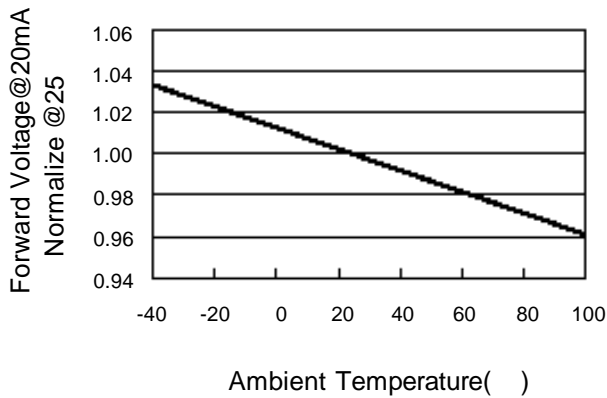

Fig.4 Luminous Intensity vs. Temperature

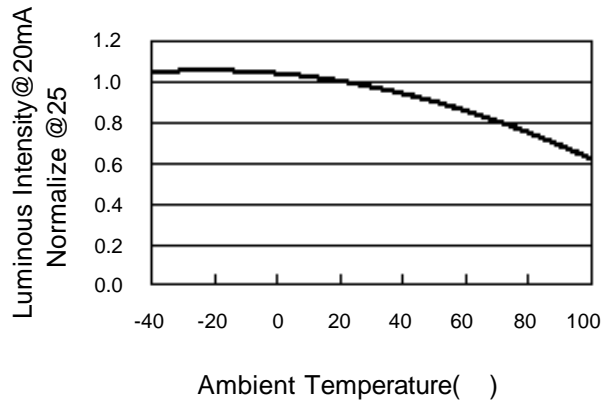
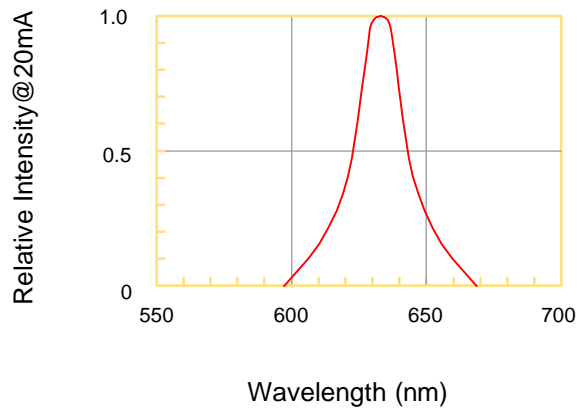

Fig.5 Relative Intensity vs. Wavelength





Recommended Soldering Conditions

1. Hand Solder

Basic spec is 280 3 sec one time only.

2. Wave Solder

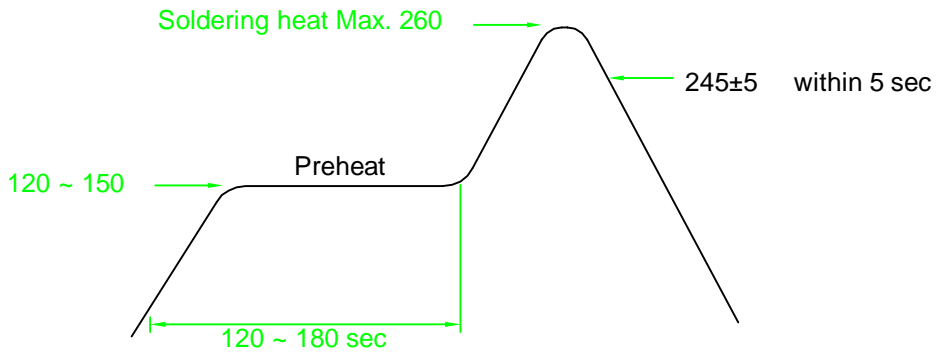

3. LEAD Reflow Solder

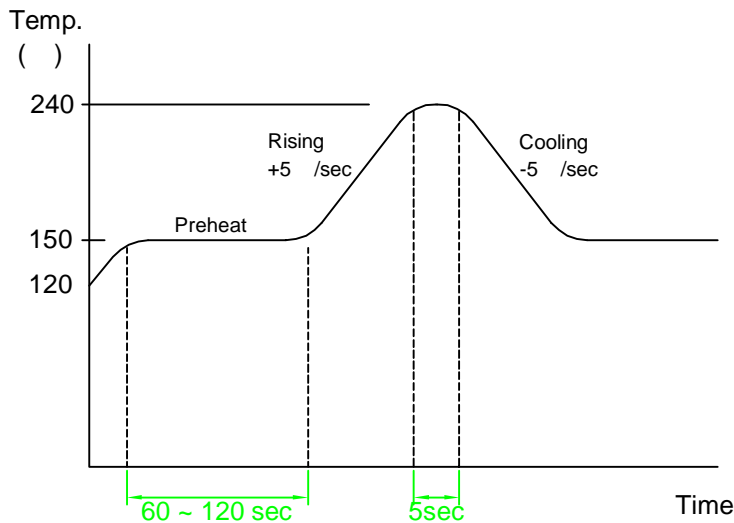

4. PB-Free Reflow Solder

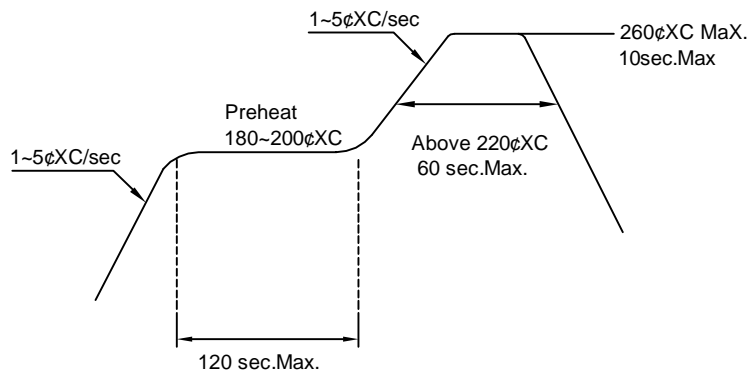

Note: 1.Wave solder and reflow soldering should not be made more than one time.
2.You can just only select one of the soldering conditions as above.

Precautions For Use:
Storage time:

- 1.The operation of Temperatures and RH are : 5 ~35 ,RH<60%.
- 2.Once the package is opened, the products should be used within a week.
 Otherwise, they should be kept in a damp proof box with descanting agent.
 Considering the tape life, we suggest our customers to use our products within a year(from production date).
- 3.If opened more than one week in an atmosphere 5 ~ 35 ,RH<60%, they should be treated at 60 ±5 fo r 15hrs.

Drive Method:

LED is a current operated device, and therefore, requirer some kind of current limiting incorporated into the driver circuit. This current limiting typically takes the form of a current limiting resistor placed in series with the LED.

Consider worst case voltage variations than could occur across the current limiting resistor. The forwrd current should not be allowed to change by more than 40 % of its desired value.

Circuit model A

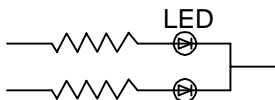

Circuit model B

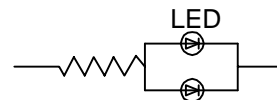

(A) Recommended circuit.

(B) The difference of brightness between LED could be found due to the VF-IF characteristics of LED.

Cleaning:

Use alcohol-based cleaning solvents such as isopropyl alcohol to clean the LED.

ESD(Electrostatic Discharge):

Static Electricity or power surge will damage the LED. Use of a conductive wrist band or anti-electrosatic glove is recommended when handing these LED. All devices, equipment and machinery must be properly grounded.



Reliability Test:

Classification	Test Item	Test Condition	Reference Standard
Endurance Test	Operating Life Test	1.Ta=Under Room Temperature As Per Data Sheet Maximum Rating. 2.If=20mA 3.t=1000 hrs (-24hrs, +72hrs)	MIL-STD-750D: 1026 MIL-STD-883D: 1005 JIS C 7021: B-1
	High Temperature Storage Test	1.Ta=105 ±5 2.t=1000 hrs (-24hrs, +72hrs)	MIL-STD-883D:1008 JIS C 7021: B-10
	Low Temperature Storage Test	1.Ta=-40 ±5 2.t=1000 hrs (-24hrs, +72hrs)	JIS C 7021: B-12
	High Temperature High Humidity Storage Test	1.IR-Reflow In-Board, 2 Times 2.Ta=65 ±5 3.RH=90%~95% 4.t=1000hrs ±2hrs	MIL-STD-202F:103B JIS C 7021: B-11
Environmental Test	Thermal Shock Test	1.IR-Reflow In-Board,2 times 2.Ta=105 ±5 & -40 ±5 (10min) (10min) 3.total 10 cycles	MIL-STD-202F: 107D MIL-STD-750D: 1051 MIL-STD-883D: 1011
	Solderability Test	1.T.Sol=235 ±5 2.Immersion time 2 ±0.5sec 3.Immersion rate 25 ±2.5mm/sec 4.Immersion rate 25 ±2.5mm/sec 5.Coverage 95% of the dipped surface	MIL-STD-202F: 208D MIL-STD-750D: 2026 MIL-STD-883D: 2003 IEC 68 Part 2-20 JIS C 7021: A-2
	Temperature Cycling	1.105 ~ 25 ~ 55 ~ 25 30mins 5mins 30mins 5mins 2.10 Cycles	MIL-STD-202F: 107D MIL-STD-750D: 1051 MIL-STD-883D: 1010 JIS C 7021: A-4
	Solderability Test	Ramp-up rate(183 to Peak) +3 second max Temp. maintain at 125(±25) 120 seconds max Temp. maintain above 183 60-150 seconds Peak temperature range 235 +5-0 Time within 5 of actual Peak Temperature(tp) 10-30 seconds Ramp-down rate +6 /second max	MIL-STD-750D:2031.2 J-STD-020