

**FM220C
THRU
FM260C**

SURFACE MOUNT SCHOTTKY BARRIER RECTIFIER

VOLTAGE RANGE 20 to 60 Volts CURRENT 2.0 Ampere

FEATURES

- * Low switching noise
- * Low forward voltage drop
- * High current capability
- * High switching capability
- * High surge capability
- * High reliability

MECHANICAL DATA

- * Case: Molded plastic
- * Epoxy: Device has UL flammability classification 94V-O
- * Lead: MIL-STD-202E method 208C guaranteed
- * Metallurgically bonded construction
- * Mounting position: Any
- * Weight: 0.24 gram

MAXIMUM RATINGS AND ELECTRICAL CHARACTERISTICS

Ratings at 25 °C ambient temperature unless otherwise specified.
Single phase, half wave, 60 Hz, resistive or inductive load.
For capacitive load, derate current by 20%.

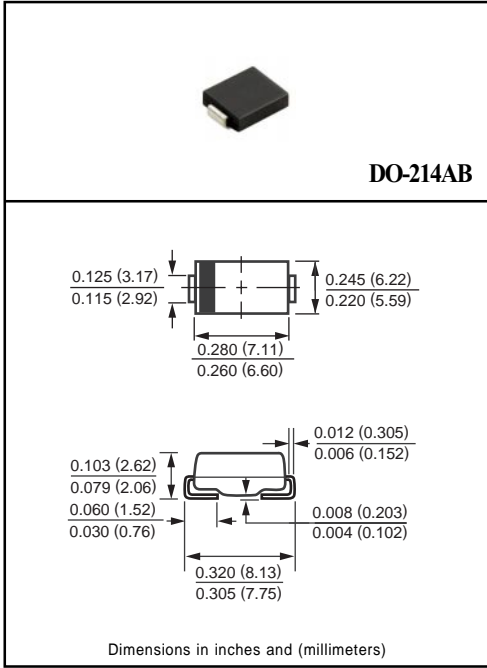

MAXIMUM RATINGS (At TA = 25°C unless otherwise noted)

RATINGS	SYMBOL	FM220C	FM230C	FM240C	FM250C	FM260C	UNITS
Maximum Recurrent Peak Reverse Voltage	VRRM	20	30	40	50	60	Volts
Maximum RMS Voltage	VRMS	14	21	28	35	42	Volts
Maximum DC Blocking Voltage	VDC	20	30	40	50	60	Volts
Maximum Average Forward Rectified Current at Derating Lead Temperature	IO	2.0					Amps
Peak Forward Surge Current 8.3 ms single half sine-wave superimposed on rated load (JEDEC method)	IFSM	50					Amps
Typical Thermal Resistance (Note 1)	R θJA	40					°C/W
Typical Junction Capacitance (Note 2)	CJ	130					pF
Operating Temperature Range	TJ	-65 to + 125			-65 to + 150		°C
Storage Temperature Range	TSTG	-65 to + 150					°C

ELECTRICAL CHARACTERISTICS (At TA = 25°C unless otherwise noted)

CHARACTERISTICS	SYMBOL	FM220C	FM230C	FM240C	FM250C	FM260C	UNITS
Maximum Instantaneous Forward Voltage at 2.0A DC	VF	.55			.70		Volts
Maximum Average Reverse Current at Rated DC Blocking Voltage	IR	1.0			10		mAmps
		@ TA = 25°C					
		@ TA = 100°C					

NOTES : 1. Thermal Resistance (Junction to Ambient): Vertical PC Board Mounting, 0.5" (12.7mm) Lead Length.
2. Measured at 1 MHz and applied reverse voltage of 4.0 volts.

RATING AND CHARACTERISTIC CURVES (FM220C THRU FM260C)

FIG. 1 - TYPICAL FORWARD CURRENT DERATING CURVE

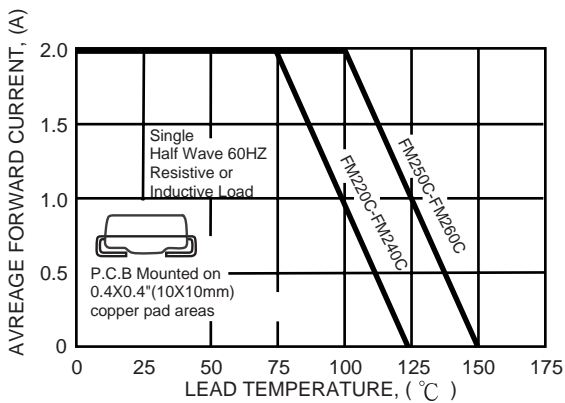

FIG. 2 - TYPICAL INSTANTANEOUS FORWARD CHARACTERISTICS

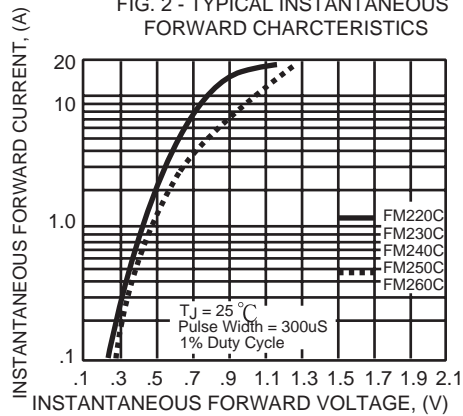

FIG. 3A - TYPICAL REVERSE CHARACTERISTICS

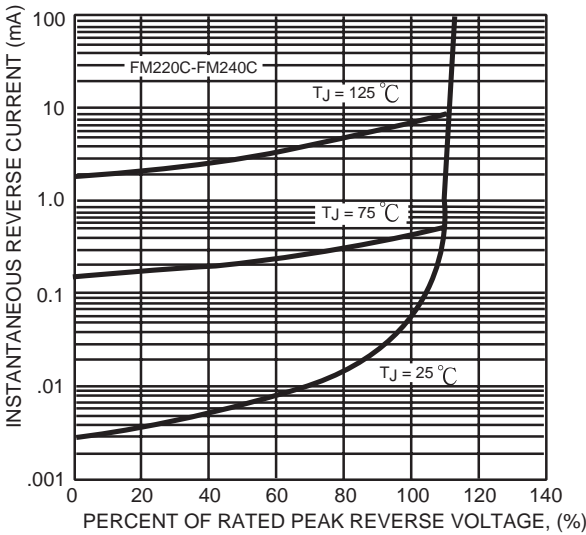

FIG. 3B - TYPICAL REVERSE CHARACTERISTICS

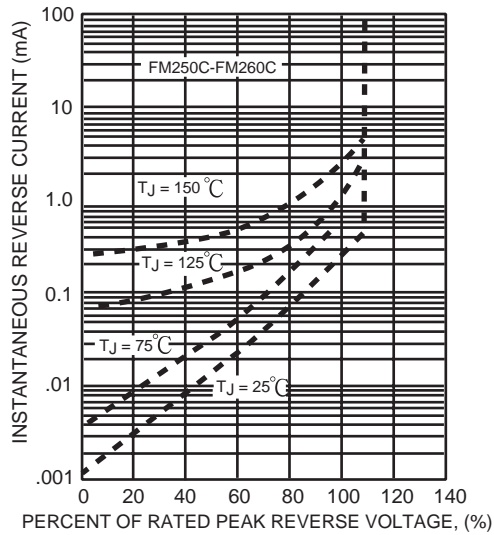

FIG. 4 - TYPICAL JUNCTION CAPACITANCE

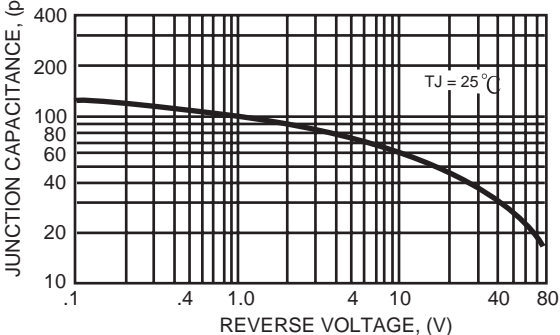
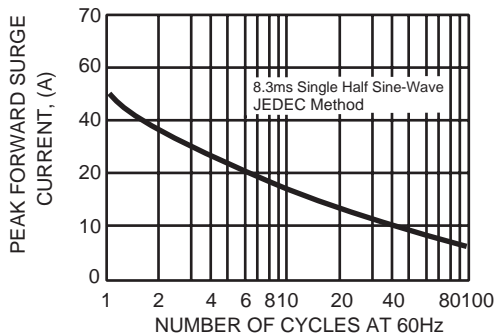
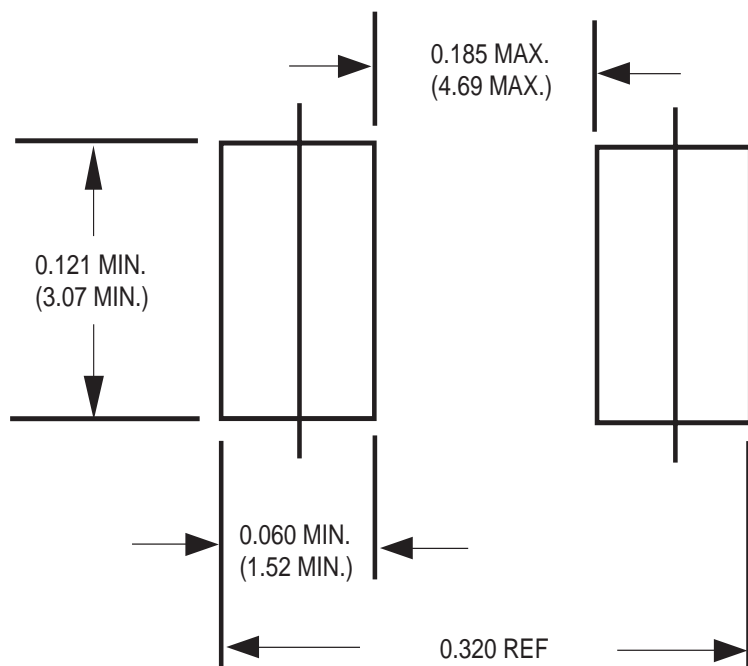

FIG. 5 - MAXIMUM NON-REPETITIVE FORWARD SURGE CURRENT



Mounting Pad Layout



Dimensions in inches and (millimeters)