



**TGL6425-SCC**

**Digital Attenuator**

# 6425

- 0.5 to 18-GHz Frequency Range
- 5-Bit Step Attenuator
- 15.5-dB Attenuation Range
- 4-dB Typical Insertion Loss
- 1.6:1 Input/Output SWR
- 2,1844 x 1,8288 x 0,1016 mm (0.086 x 0.072 x 0.004 in.)

PHOTO ENLARGEMENT

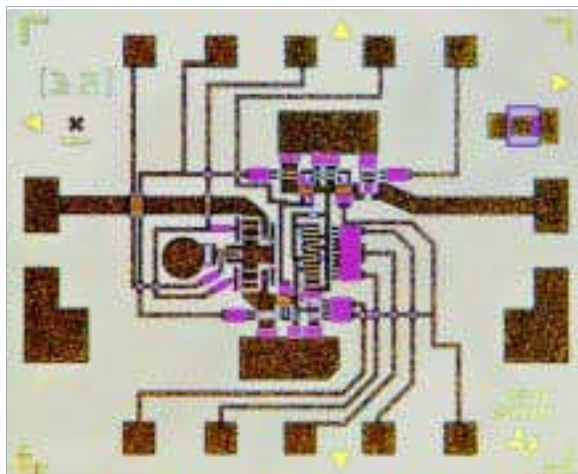

DESCRIPTION

The TriQuint TGL6425-SCC is a GaAs MMIC 5-bit FET attenuator which operates from 0.5 to 18-GHz. The attenuation step is 0.5-dB and is controlled by 10 input lines. Control bias voltages are 0 V and -5 V. The input and output return loss is typically 13-dB.

This unique absorptive design combines both "T" and "PI" configurations to produce an extremely small size and low insertion loss attenuator. The small size and reliability advantage of a monolithic attenuator over a hybrid design make this device attractive for use in electronic warfare, radar, telecommunication, and navigation systems for level set, modulation and switching functions.

Bond pad and backside metallization is gold plated for compatibility with eutectic alloy attachment method as well as the thermocompression and thermosonic wire bonding processes. Ground is provided to the circuitry through vias to the backside metallization.

TYPICAL ATTENUATION

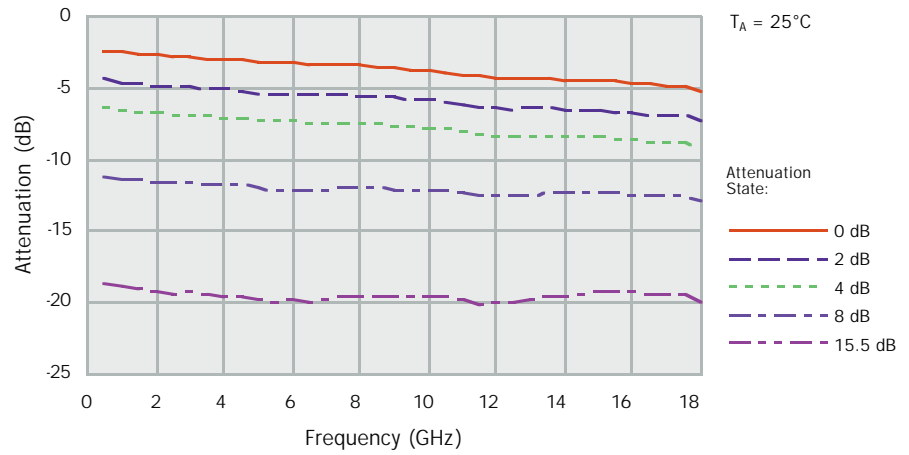

TYPICAL INPUT POWER  
 $P_{1dB}$

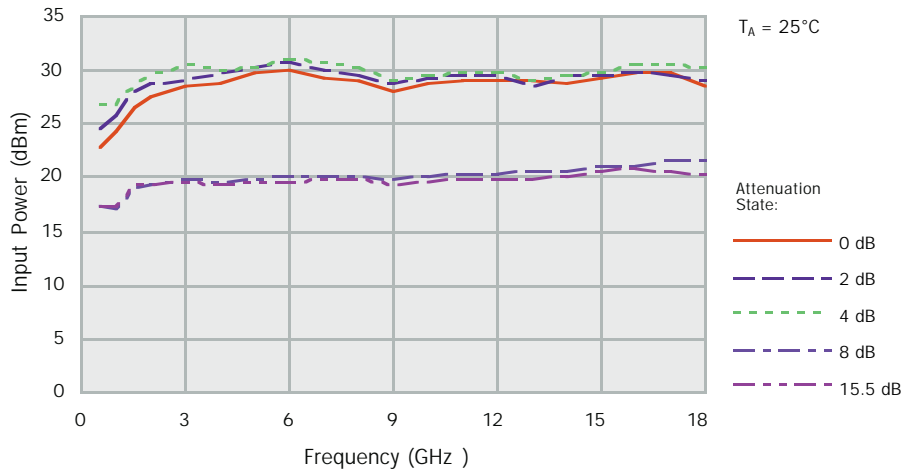

TYPICAL INPUT RETURN LOSS

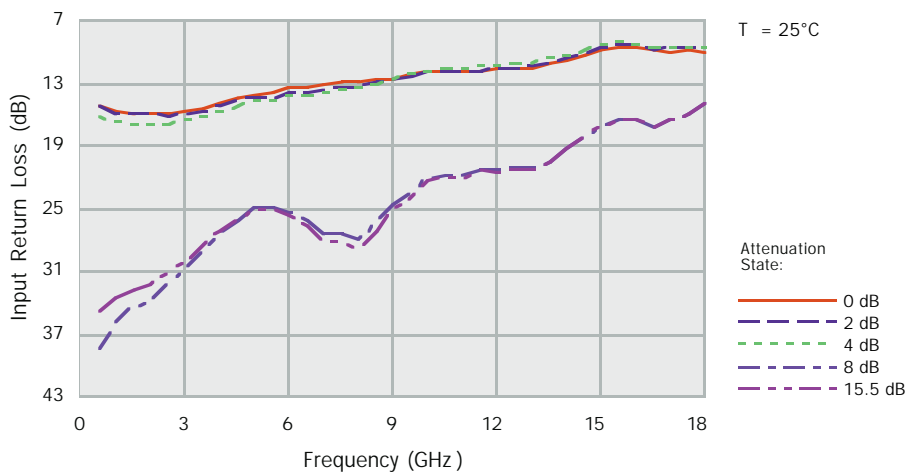

TYPICAL  
OUTPUT RETURN LOSS

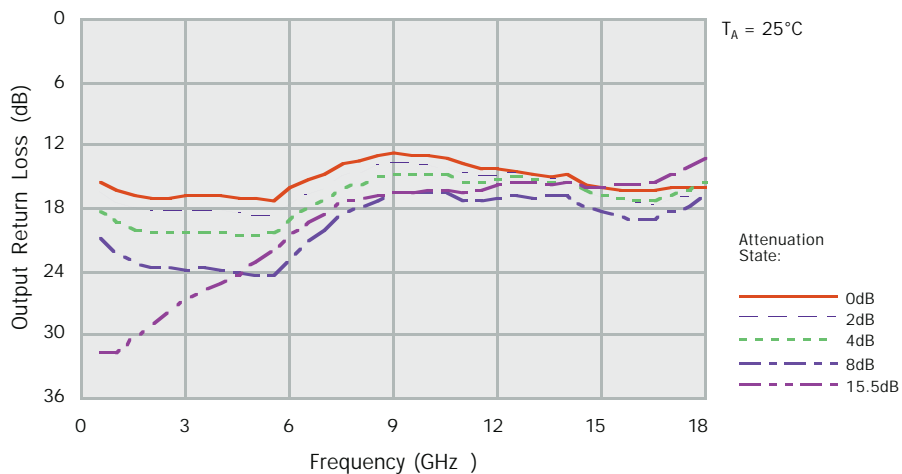

ABSOLUTE  
MAXIMUM RATINGS

Input continuous wave power,  $P_{IN}$  ..... 1 W  
 Control voltage range, V1, V2, V3, V4, V5, V6, V7, V8, V9, V10 ..... -10 V to 0 V  
 Operating channel temperature,  $T_{CH}^*$  ..... 150 °C  
 Mounting temperature (30 sec),  $T_M$  ..... 320 °C  
 Storage temperature range,  $T_{STG}$  ..... -65 to 150 °C

Ratings over operating channel temperature range,  $T_{CH}$  (unless otherwise noted)

Stresses beyond those listed under “Absolute Maximum Ratings” may cause permanent damage to the device. These are stress ratings only and functional operation of the device at these or any other conditions beyond those indicated under “RF Characteristics” is not implied. Exposure to absolute maximum rated conditions for extended periods may affect device reliability.

\*Operating channel temperature,  $T_{CH}$ , will directly affect the device MTTF . For maximum life, it is recommended that channel temperature be maintained at the lowest possible level.

RF CHARACTERISTICS

PARAMETER	TEST CONDITIONS	TYPICAL	UNIT
Attenuation		see next table	dB
SWR(in) Input standing wave ratio	f = 2 - 18 GHz (all states)	1.6:1	-
SWR(out) Output standing wave ratio	f = 2 - 18GHz (all states)	1.4:1	-
$P_{1dB}$ (in) Input power at 1-dB gain compression		see next table	dBm

$T_A = 25^\circ C$

## RF CHARACTERISTICS

ATTENUATION STATE (dB)	TYPICAL ATTENUATION at 9 GHz (dB)	TYPICAL VARIANCE at 9 GHz (dB)	TYPICAL INPUT POWER 1-dB Gain Compression at 2-18 GHz (dBm)
0	3.6	± 0.25	28
0.5	4.1	± 0.25	28
1	4.4	± 0.25	29
2	5.7	± 0.25	29
4	7.6	± 0.25	29
8	12.1	± 0.45	20
15.5	19.7	± 0.7	20

## BIAS TRUTH TABLE

ATTEN STATE (dB)	V <sub>1</sub>	V <sub>2</sub>	V <sub>3</sub>	V <sub>4</sub>	V <sub>5</sub>	V <sub>6</sub>	V <sub>7</sub>	V <sub>8</sub>	V <sub>9</sub>	V <sub>10</sub>
0.0	-5	0	-5	-5	-5	0	0	0	0	-5
0.5	-5	0	-5	-5	-5	0	0	0	0	0
1.0	-5	0	-5	-5	0	0	-5	-5	0	-5
1.5	-5	0	-5	-5	0	0	-5	-5	0	0
2.0	-5	0	-5	0	-5	-5	0	0	-5	-5
2.5	-5	0	-5	0	-5	-5	0	0	-5	0
3.0	-5	0	-5	0	0	-5	0	-5	-5	-5
3.5	-5	0	-5	0	0	-5	0	-5	-5	0
4.0	-5	0	0	-5	-5	-5	-5	0	0	-5
4.5	-5	0	0	-5	-5	-5	-5	0	0	0
5.0	-5	0	0	-5	0	-5	-5	0	-5	-5
5.5	-5	0	0	-5	0	-5	-5	0	-5	0
6.0	-5	0	0	0	-5	-5	-5	-5	0	-5
6.5	-5	0	0	0	-5	-5	-5	-5	0	0
7.0	-5	0	0	0	0	-5	-5	-5	-5	-5
7.5	-5	0	0	0	0	-5	-5	-5	-5	0
8.0	0	-5	-5	-5	-5	0	0	0	0	-5
8.5	0	-5	-5	-5	-5	0	0	0	0	0
9.0	0	-5	-5	-5	0	0	-5	-5	0	-5
9.5	0	-5	-5	-5	0	0	-5	-5	0	0
10.0	0	-5	-5	0	-5	-5	0	0	-5	-5
10.5	0	-5	-5	0	-5	-5	0	0	-5	0
11.0	0	-5	-5	0	0	-5	0	-5	-5	-5
11.5	0	-5	-5	0	0	-5	0	-5	-5	0
12.0	0	-5	0	-5	-5	-5	-5	0	0	-5
12.5	0	-5	0	-5	-5	-5	-5	0	0	0
13.0	0	-5	0	-5	0	-5	-5	0	-5	-5
13.5	0	-5	0	-5	0	-5	-5	0	-5	0
14.0	0	-5	0	0	-5	-5	-5	-5	0	-5
14.5	0	-5	0	0	-5	-5	-5	-5	0	0
15.0	0	-5	0	0	0	-5	-5	-5	-5	-5
15.5	0	-5	0	0	0	-5	-5	-5	-5	0

EQUIVALENT SCHEMATIC

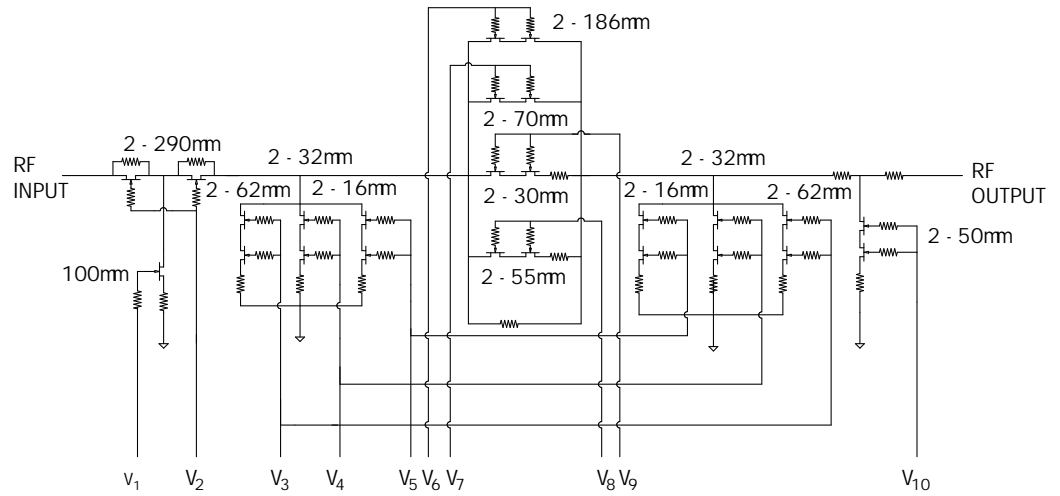

BIAS NETWORK

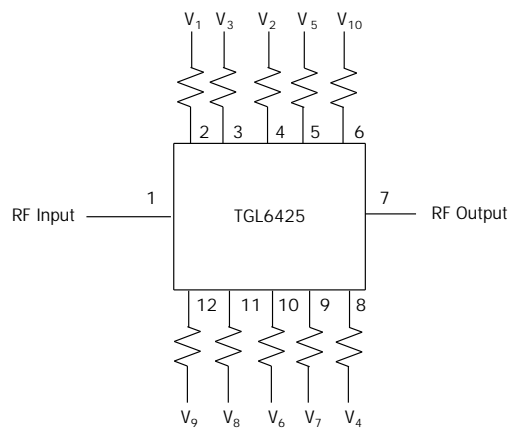

All bias resistors have a nominal value of 25 - Ohms.

RF connections: Bond using two 1-mil diameter , 20 to 25-mil-length gold bond wires at both RF Input and RF Output for optimum RF performance.

DC blocks are not provided at RF ports.

Close placement of external components is essential to resonant-free performance.

MECHANICAL DRAWING

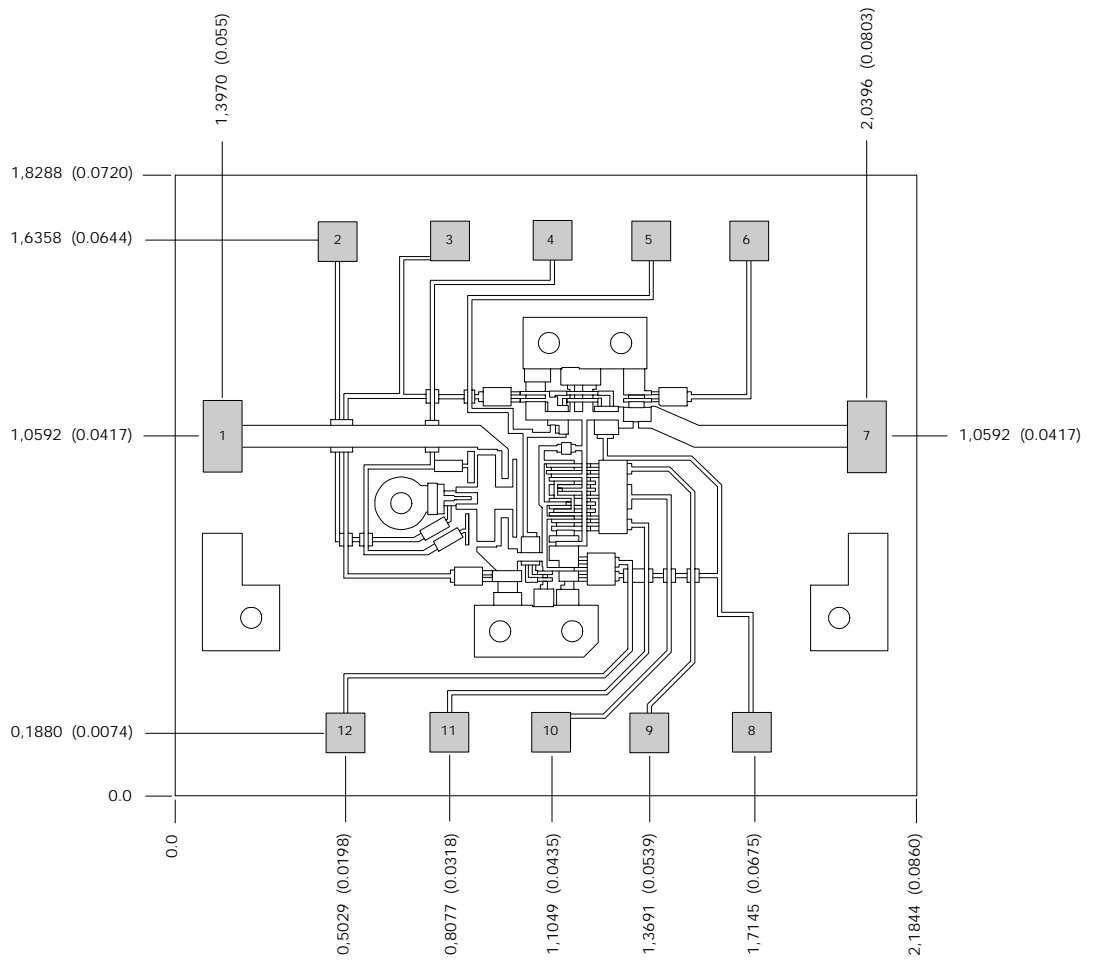

Units: Millimeters (inches)  
 Thickness: 0,102 (0.004) (reference only)  
 Chip edge to bond pad dimensions are shown to center of bond pad.  
 Chip size ±0,0508 (0.002)

Bond pad #1 (RF In): 0,127 x 0,207 (0.0050 x 0.0082)	Bond pad #7 (RF Out): 0,246 x 0,119 (0.0097 x 0.0047)
Bond pad #2 (V <sub>1</sub> ): 0,120 x 0,120 (0.0047 x 0.0047)	Bond pad #8 (V <sub>4</sub> ): 0,120 x 0,120 (0.0047 x 0.0047)
Bond pad #3 (V <sub>3</sub> ): 0,120 x 0,120 (0.0047 x 0.0047)	Bond pad #9 (V <sub>7</sub> ): 0,120 x 0,120 (0.0047 x 0.0047)
Bond pad #4 (V <sub>2</sub> ): 0,120 x 0,120 (0.0047 x 0.0047)	Bond pad #10 (V <sub>6</sub> ): 0,120 x 0,120 (0.0047 x 0.0047)
Bond pad #5 (V <sub>5</sub> ): 0,120 x 0,120 (0.0047 x 0.0047)	Bond pad #11 (V <sub>8</sub> ): 0,120 x 0,120 (0.0047 x 0.0047)
Bond pad #6 (V <sub>10</sub> ): 0,120 x 0,120 (0.0047 x 0.0047)	Bond pad #12 (V <sub>9</sub> ): 0,120 x 0,120 (0.0047 x 0.0047)

OVERVIEW

The following is a suggested driver circuit for the TriQuint TGL6425-SCC 0.5 to 18 -Ghz step attenuator. The circuit allows the user to use a digital binary input to achieve the desired level of attenuation; with a digital word of "00000" equaling 0-dB relative attenuation and "11111" equaling 15.5-dB relative attenuation. The JFET s (2N5116 or equivalent) provide the required level shift from TTL voltages to attenuation control levels. The 2 -input NOR gates should be CMOS (74C02 or equivalent) with 0 V applied to the positive supply terminal and -5 V on the negative supply terminal.

DRIVER CIRCUIT SCHEMATIC

