

SURFACE MOUNT SCHOTTKY BARRIER DIODE ARRAYS

NEW PRODUCT

Features

- Low Forward Voltage Drop
- Fast Switching
- Ultra-Small Surface Mount Package
- PN Junction Guard Ring for Transient and ESD Protection
- Also Available in Lead Free Version

Mechanical Data

- Case: SOT-363, Molded Plastic
- Case material - UL Flammability Rating Classification 94V-0
- Moisture sensitivity: Level 1 per J-STD-020A
- Terminals: Solderable per MIL-STD-202, Method 208
- Also Available in Lead Free Plating (Matte Tin Finish). Please see Ordering Information, Note 4, on Page 3
- Orientation: See Diagrams Below
- Weight: 0.006 grams (approx.)
- Marking: See Diagrams Below & Page 3

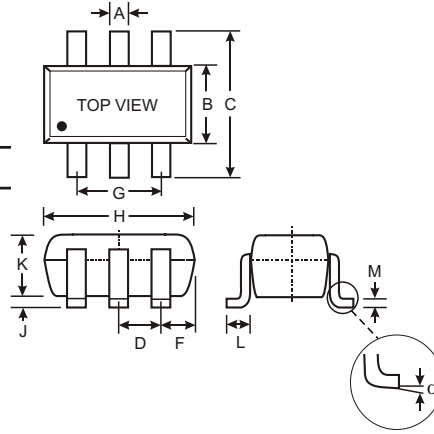

SOT-363		
Dim	Min	Max
A	0.10	0.30
B	1.15	1.35
C	2.00	2.20
D	0.65 Nominal	
F	0.30	0.40
H	1.80	2.20
J	—	0.10
K	0.90	1.00
L	0.25	0.40
M	0.10	0.25
α	0°	8°
All Dimensions in mm		

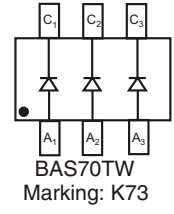
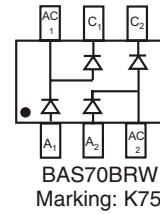
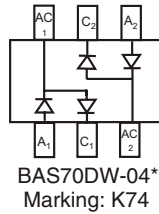
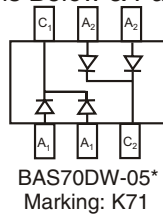
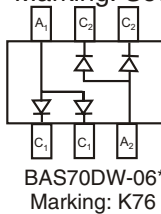

*Symmetrical configuration, no orientation indicator.

Maximum Ratings @ $T_A = 25^\circ\text{C}$ unless otherwise specified

Characteristic	Symbol	Value	Unit
Peak Repetitive Reverse Voltage Working Peak Reverse Voltage DC Blocking Voltage	V_{RRM} V_{RWM} V_R	70	V
RMS Reverse Voltage	$V_{R(RMS)}$	49	V
Forward Continuous Current (Note 1)	I_{FM}	70	mA
Non-Repetitive Peak Forward Surge Current @ $t < 1.0\text{s}$	I_{FSM}	100	mA
Power Dissipation (Note 1)	P_d	200	mW
Thermal Resistance Junction to Ambient Air (Note 1)	$R_{\theta JA}$	625	$^\circ\text{C/W}$
Operating and Storage Temperature Range	T_j T_{STG}	-55 to +125 -65 to +125	$^\circ\text{C}$

Electrical Characteristics @ $T_A = 25^\circ\text{C}$ unless otherwise specified

Characteristic	Symbol	Min	Max	Unit	Test Condition
Forward Voltage (Note 2)	V_F	—	410 1000	mV mV	$t_p < 300\mu\text{s}$, $I_F = 1.0\text{mA}$ $t_p < 300\mu\text{s}$, $I_F = 15\text{mA}$
Reverse Current (Note 2)	I_R	—	100	nA	$t_p < 300\mu\text{s}$, $V_R = 50\text{V}$
Total Capacitance	C_T	—	2.0	pF	$V_R = 0\text{V}$, $f = 1.0\text{MHz}$
Reverse Recovery Time	t_{rr}	—	5.0	ns	$I_F = I_R = 10\text{mA}$ to $I_R = 1.0\text{mA}$, $I_{rr} = 0.1 \times I_R$, $R_L = 100\Omega$

Notes: 1. Part mounted on FR-4 board with recommended pad layout, which can be found on our website at <http://www.diodes.com/datasheets/ap02001.pdf>.

2. Short duration test pulse used to minimize self-heating effect.

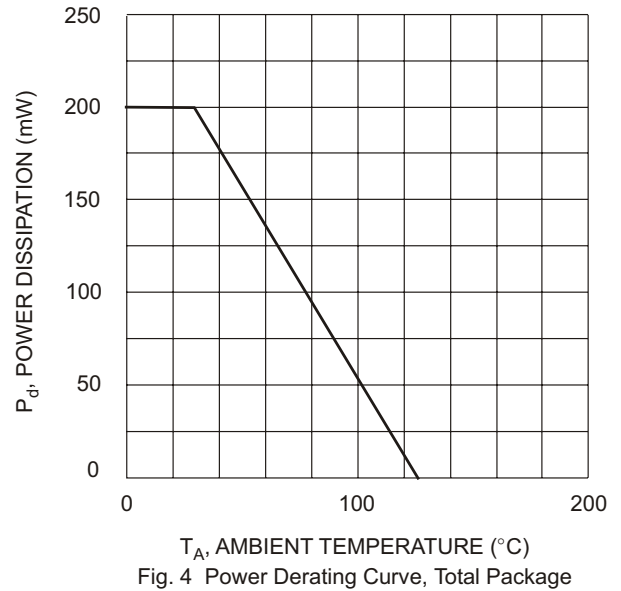
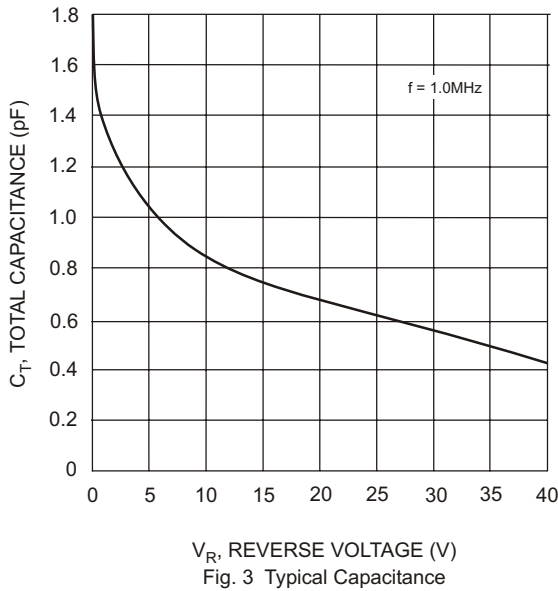
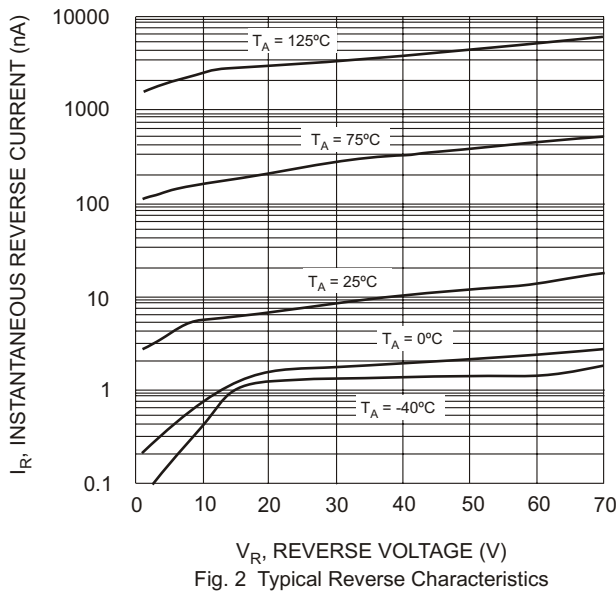
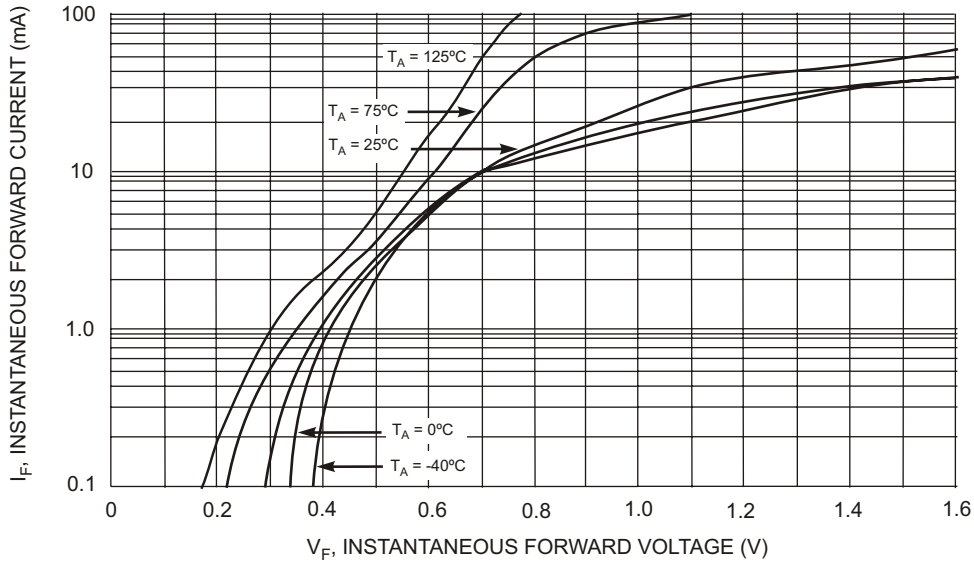

Ordering Information (Note 3)

Device	Packaging	Shipping
BAS70DW-04-7	SOT-363	3000/Tape & Reel
BAS70DW-05-7	SOT-363	3000/Tape & Reel
BAS70DW-06-7	SOT-363	3000/Tape & Reel
BAS70BRW-7	SOT-363	3000/Tape & Reel
BAS70TW-7	SOT-363	3000/Tape & Reel

- Notes: 3. For Packaging Details, go to our website at <http://www.diodes.com/datasheets/ap02007.pdf>.
 4. For Lead Free version (with Lead Free terminal finish) part number, please add "-F" suffix to part number above.
 Example: BAS70TW-7-F.

Marking Information

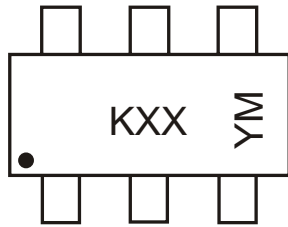

KXX = Product Type Marking Code (See Page 1)
 YM = Date Code Marking
 Y = Year ex: N = 2002
 M = Month ex: 9 = September

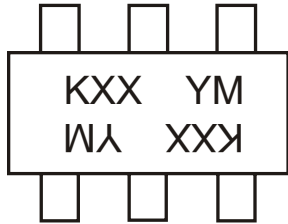

KXX = Product Type Marking Code (See Page 1)
 For Symmetrical Configuration, No Orientation Indicator
 YM = Date Code Marking
 Y = Year ex: N = 2002
 M = Month ex: 9 = September

Date Code Key

Year	2001	2002	2003	2004	2005	2006	2007	2008	2009
Code	M	N	P	R	S	T	U	V	W

Month	Jan	Feb	March	Apr	May	Jun	Jul	Aug	Sep	Oct	Nov	Dec
Code	1	2	3	4	5	6	7	8	9	O	N	D