

<b>Title</b>	<b><i>Reference Design Report for a High Efficiency (<math>\geq 85\%</math>), High Power Factor (<math>&gt; 0.9</math>) TRIAC Dimmable 14 W LED Driver Using LinkSwitch<sup>TM</sup>-PH LNK406EG</i></b>
<b>Specification</b>	90 VAC – 265 VAC Input; 28 V <sub>TYP</sub> , 0.5 A Output
<b>Application</b>	LED Driver
<b>Author</b>	Applications Engineering Department
<b>Document Number</b>	RDR-194
<b>Date</b>	December 14, 2010
<b>Revision</b>	1.1

#### **Summary and Features**

- Superior performance and end user experience
  - TRIAC dimmer compatible (including low cost leading edge type)
    - No output flicker
    - $> 1000:1$  dimming range
  - Clean monotonic start-up – no output blinking
  - Fast start-up ( $< 300$  ms) – no perceptible delay
  - Consistent dimming performance unit to unit
- Highly energy efficient
  - $\geq 85\%$  at 115 VAC,  $\geq 87\%$  at 230 VAC
- Low cost, low component count and small printed circuit board footprint solution
  - No current sensing required
  - Frequency jitter for smaller, lower cost EMI filter components
- Integrated protection and reliability features
  - Output open circuit / output short-circuit protected with auto-recovery
  - Line input overvoltage shutdown extends voltage withstand during line faults.
  - Auto-recovering thermal shutdown with large hysteresis protects both components and printed circuit board
  - No damage during brown-out or brown-in conditions
- IEC 61000-4-5 ringwave, IEC 61000-3-2 Class C and EN55015 B conducted EMI compliant

**PATENT INFORMATION**

The products and applications illustrated herein (including transformer construction and circuits external to the products) may be covered by one or more U.S. and foreign patents, or potentially by pending U.S. and foreign patent applications assigned to Power Integrations. A complete list of Power Integrations' patents may be found at [www.powerint.com](http://www.powerint.com). Power Integrations grants its customers a license under certain patent rights as set forth at <http://www.powerint.com/ip.htm>.



## Table of Contents

1	Introduction .....	5
2	Power Supply Specification .....	7
3	Schematic .....	8
4	Circuit Description .....	9
4.1	Input Filtering .....	9
4.2	LinkSwitch-PH Primary .....	9
4.3	Feedback .....	10
4.4	Output Rectification .....	11
4.5	TRIAC Phase Dimming Control Compatibility .....	11
5	PCB Layout .....	12
6	Bill of Materials .....	13
6.1	Electrical .....	13
6.2	Mechanical .....	14
7	Transformer Specification .....	15
7.1	Electrical Diagram .....	15
7.2	Electrical Specifications .....	15
7.3	Materials .....	15
7.4	Transformer Build Diagram .....	16
7.5	Transformer Construction .....	16
8	Transformer Design Spreadsheet .....	17
9	Performance Data .....	20
9.1	Power Efficiency .....	20
9.1.1	28 V .....	20
9.1.2	25 V .....	20
9.1.3	31 V .....	21
9.2	Regulation .....	22
9.2.1	Output Voltage and Line .....	22
9.2.2	Input Voltage and Output Voltage Regulation .....	23
10	Thermal Performance .....	25
10.1	$V_{IN} = 115 \text{ VAC}$ (U1: No Heat Sink) .....	25
10.2	$V_{IN} = 230 \text{ VAC}$ (U1: No Heat Sink) .....	25
11	Harmonic Data .....	26
12	Waveforms .....	28
12.1	Input Line Voltage and Current .....	28
12.2	Drain Voltage and Current .....	28
12.3	Output Voltage and Ripple Current .....	29
12.4	Output Voltage and Drain Current Start-up Profile .....	29
12.5	Output Current and Drain Voltage During Shorted Output .....	30
12.6	Open Load Output Voltage .....	30
13	Dimming .....	31
13.1	Input Phase vs. Output .....	31
13.2	Output Voltage and Input Current Waveforms .....	32
13.2.1	$V_{IN} = 115 \text{ VAC} / 60 \text{ Hz}$ .....	32
13.2.2	$V_{IN} = 230 \text{ VAC} / 50\text{Hz}$ .....	33



14	Line Surge.....	34
15	Conducted EMI .....	35
16	Production Distribution Data .....	37
17	Revision History .....	38
18	Appendix.....	39
18.1	Dimming Test with TRIAC Dimmer Switches .....	39
18.1.1	$V_{IN} = 115 \text{ VAC} / 60 \text{ Hz}$ .....	39
18.1.2	$V_{IN} = 230 \text{ VAC} / 50 \text{ Hz}$ .....	39
18.2	Audible Noise Test Data.....	40
18.2.1	$V_{IN} = 115 \text{ VAC}$ , Full Phase .....	40
18.2.2	$V_{IN} = 115 \text{ VAC}$ , Half Phase .....	40
18.2.3	$V_{IN} = 230 \text{ VAC}$ , Full Phase .....	41
18.2.4	$V_{IN} = 230 \text{ VAC}$ , Half Phase .....	41

**Important Note:** Although this board is designed to satisfy safety isolation requirements, the engineering prototype has not been agency approved. Therefore, all testing should be performed using an isolation transformer to provide the AC input to the prototype board.



## 1 Introduction

The document describes a high power-factor TRIAC dimmable LED driver designed to drive a nominal LED string voltage of 28 V at 0.5 A from an input voltage range of 90 VAC to 265 VAC. The LED driver utilizes the LNK406EG from the LinkSwitch-PH family of ICs.

LinkSwitch-PH ICs allow the implementation of cost effective and low component count LED drivers which both meet power factor and harmonics limits but also offer enhanced end user experience. This includes ultra-wide dimming range, flicker free operation (even with low cost with AC line TRIAC dimmers) and fast, clean turn on.

The topology used is an isolated Flyback operating in continuous conduction mode. Output current regulation is sensed entirely from the primary side eliminating the need for secondary side feedback components. No external current sensing is required on the primary side either as this is performed inside the IC further reducing components and losses. The internal controller adjusts the MOSFET duty cycle to maintain a sinusoidal input current and therefore high power factor and low harmonic currents.

The LNK406EG also provides a sophisticated range of protection features including auto-restart for open control loop and output short-circuit conditions. Line overvoltage provides extended line fault and surge withstand, output overvoltage protects the supply should the load be disconnect and accurate hysteretic thermal shutdown ensures safe average PCB temperatures under all conditions.

In any LED luminaire the driver determines many of the performance attributes experienced by the end customer (user) including startup time, dimming, flicker and unit to unit consistency. For this design a focus was given to compatibility with as wider range of dimmers and as large of a dimming range as possible, at both 115 VAC and 230 VAC. However simplification of the design is possible for both single input voltage operation, no dimming or operation with a limited range of (higher quality) dimmers.

This document contains the LED driver specification, schematic, PCB diagram, bill of materials, transformer documentation and typical performance characteristics.



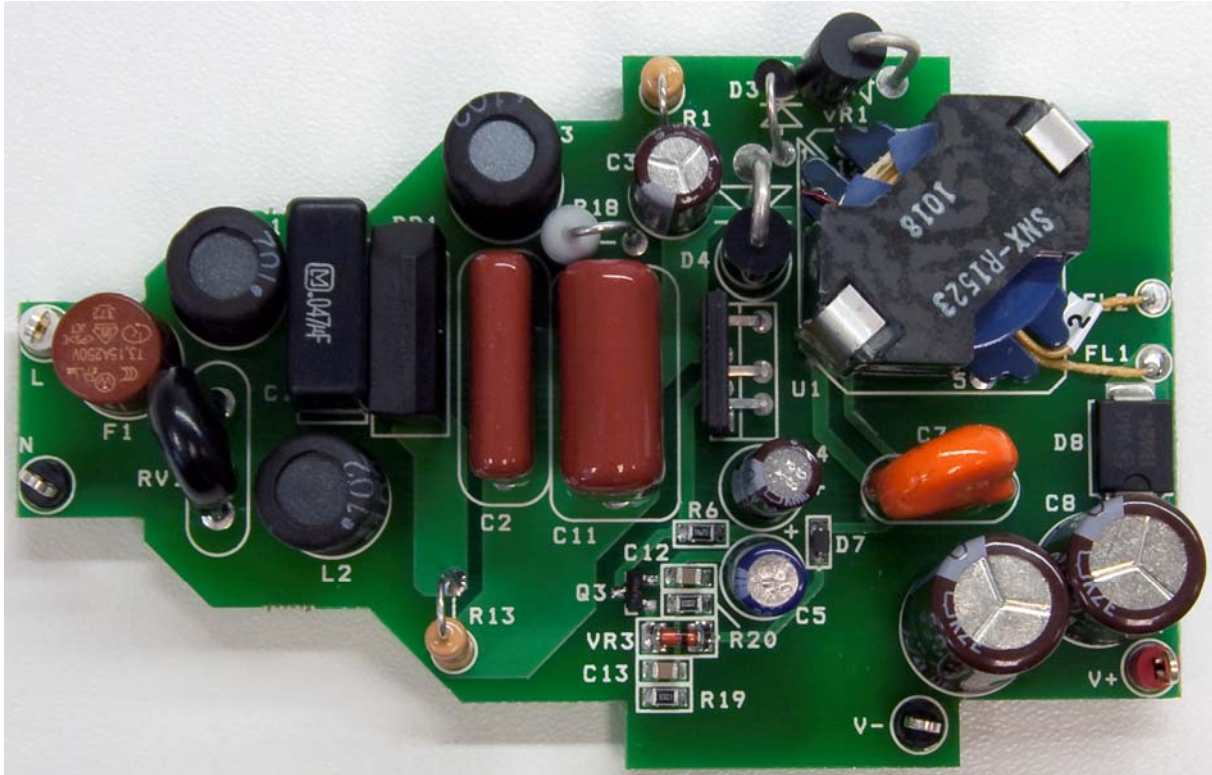


Figure 1 – Populated Circuit Board Photograph (Top view). PCB Outline Designed to Fit Inside PAR38 Enclosure.

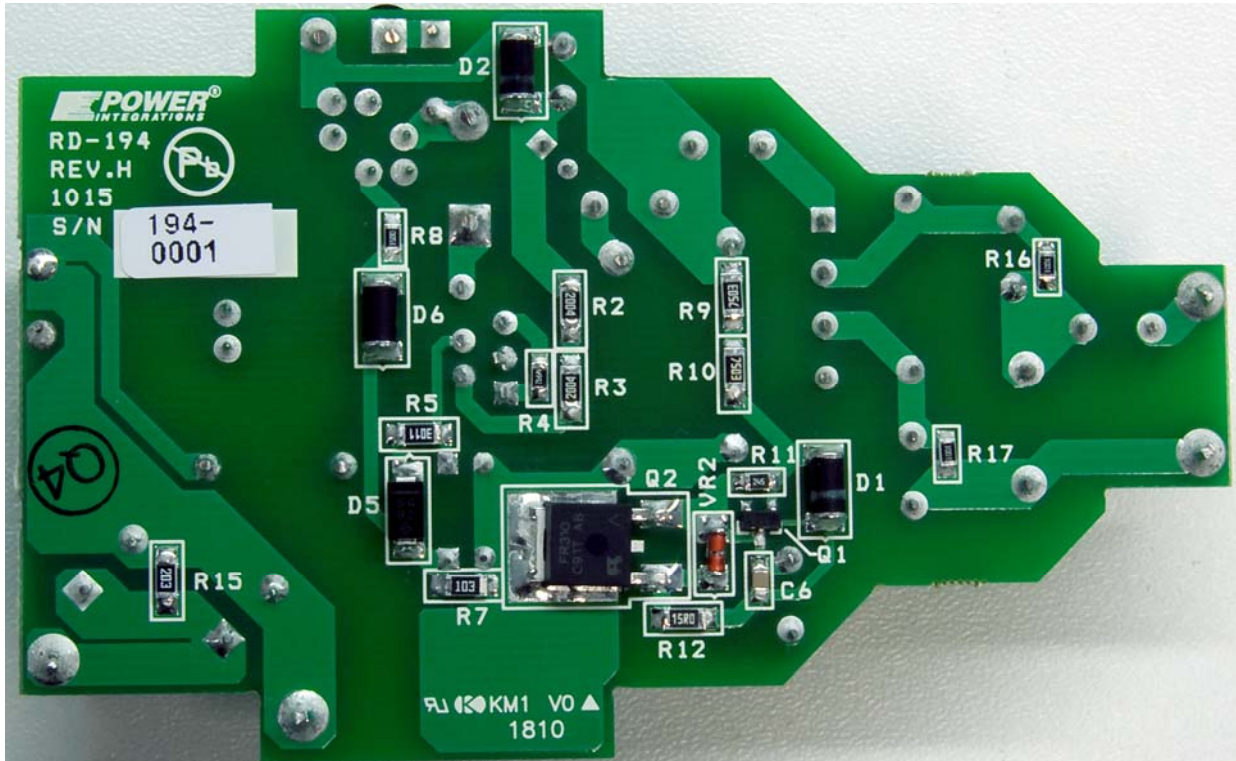


Figure 2 – Populated Circuit Board Photograph (Bottom View).



## 2 Power Supply Specification

The table below represents the minimum acceptable performance of the design. Actual performance is listed in the results section.

Description	Symbol	Min	Typ	Max	Units	Comment
<b>Input</b>						
Voltage <sup>a</sup>	$V_{IN}$	90	115	265	VAC	2 Wire – no P.E.
Frequency	$f_{LINE}$	47	50/60	64	Hz	
<b>Output</b>						
Output Voltage	$V_{OUT}$	24	28	32	V	$V_{OUT} = 28, V_{IN} = 115 \text{ VAC}, 25^{\circ}\text{C}$
Output Current <sup>a</sup>	$I_{OUT}$	0.475	0.5	0.525	A	
<b>Total Output Power</b>						
Continuous Output Power	$P_{OUT}$		14		W	
<b>Efficiency</b>						
Full Load	$\eta$	80			%	Measured at $P_{OUT} 25^{\circ}\text{C}$
<b>Environmental</b>						
Conducted EMI		CISPR 15B / EN55015B				IEC 61000-4-5, 200 A
Safety		Designed to meet IEC950 / UL1950 Class II				
Ring Wave (100 kHz) Differential Mode (L1-L2) Common mode (L1/L2-PE)			2.5		kV	
Power Factor		0.9				Measured at $V_{OUT(TYP)}, I_{OUT(TYP)}$ and 115/230 VAC
Harmonics		EN 61000-3-2 Class D				
Ambient Temperature <sup>b</sup>	$T_{AMB}$			60	$^{\circ}\text{C}$	Free convection, sea level

### Notes:

<sup>a</sup> When configured for phase controlled (TRIAC) dimming, to give widest dimming range, the output current for a LinkSwitch-PH design varies with line voltage. Therefore the output current specification is defined at a single line voltage only. For this design a line voltage of 115 VAC was selected. At higher line voltages the output current will increase and reduce with lower line voltages. The typical output current variation is +20% for a +200% in line voltage. A single resistor value change can be used to center the nominal output current for a given nominal line voltage. See Table 1 for the feedback resistor value vs. nominal line voltage.

<sup>b</sup> Maximum ambient temperature may be increased by adding a small heat sink to the LinkSwitch-PH device. For example a strip of aluminum the width of the board and the height of the existing electrolytic capacitors increases maximum allowable ambient to 70°C for a device temperature of 100°C. Higher device temperatures, up to 115°C, are allowable providing a reduction in output current tolerance is acceptable.



### 3 Schematic

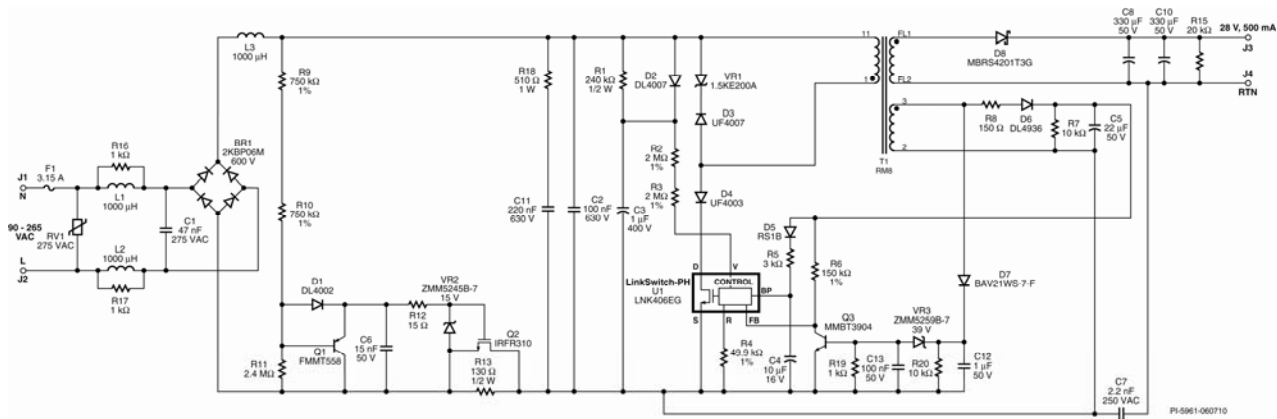


Figure 3 – Schematic.





## 4 Circuit Description

The LinkSwitch-PH device is a controller and integrated 725 V MOSFET intended for use in LED driver applications. The LinkSwitch-PH is configured for use in a single-stage continuous conduction mode Flyback topology and provides a primary side regulated constant current output while maintaining high power factor from the AC input.

### 4.1 Input Filtering

Fuse F1 provide protection from component failure and RV1 provides a clamp to limit the maximum voltage during differential line surge events. A 275 VAC rated part was selected, being slightly above the maximum specified operating voltage of 265 VAC. Diode bridge BR1 rectifies the AC line voltage with capacitor C2 providing a low impedance path (decoupling) for the primary switching current. A low value of capacitance (sum of C1, C2 and C11) is necessary to maintain a power factor of greater than 0.9.

EMI filtering is provided by inductors L1-L3, C1 and Y1 safety rated C7. Resistor R16 and R17 across L1 and L2 damp any resonances between the input inductors, capacitors and the AC line impedance which would ordinarily show up on the conducted EMI measurements.

### 4.2 LinkSwitch-PH Primary

One side of the transformer (T1) is connected to the DC bus and the other to the DRAIN pin of the LinkSwitch-PH. During the on-time of the MOSFET current ramps through the primary storing energy which is then delivered to the output during the MOSFET off time. An RM8 core size was selected due to its small board area footprint. As the bobbin did not meet the 6.2 mm safety creepage distance required for 230 VAC operation, flying leads were used to terminated the secondary winding into the PC board.

To provide peak line voltage information to U1 the incoming rectified AC peak charges C3 via D2. This is then fed into the V pin of U1 as a current via R2 and R3. The resistor tolerance will cause V pin current variation unit to unit so 1% types were selected to minimize this variation. The V pin current is also used by the device to set the line input over-voltage and under voltage protection thresholds. Undervoltage ensures a defined turn on voltage threshold unit to unit and overvoltage extends the rectified line voltage withstand (during surges and line swells) to the 725  $BV_{DSS}$  rating of the internal MOSFET. Resistor R1 provides a discharge path for C3 with a time constant much longer than that of the rectified AC to prevent the V pin current being modulated at the line frequency.

The V-pin current and the FB-pin current are used internally to control the average output LED current. For phase angle dimming applications a 50 k $\Omega$  resistor is used on the R pin (R4) and 4 M $\Omega$  (R2+R3) on the V pin to provide a linear relationship between input voltage and the output current and maximizing the dim range. Resistor R4 also sets the internal line input brown in, brown out and input over voltage protection thresholds.



During the MOSFET on time diode D3 and VR1 clamp the drain voltage to a safe level due to the effects of leakage inductance. Diode D4 is necessary to prevent reverse current from flowing through U1 while the voltage across C2 falls to below the reflected output voltage ( $V_{OR}$ ). A Schottky barrier type diode was selected to reduce the loss in this component and improve efficiency but an ultra-fast PN type (UF54002) may be substituted for lower cost.

Diode D6, C5, R7 and R8 generate a primary bias supply from an auxiliary winding on the transformer. Capacitor C4 provides local decoupling for the BP pin of U1 which is the supply pin for the internal controller. During startup C4 is charged to ~6 V from an internal high-voltage current source tied to the DRAIN pin. This allows the part to start switching at which point the operating supply current is provided from the bias supply via R5. Diode D5 isolates the BYPASS pin from C5 to prevent the startup time increasing due to charging of both C4 and C5.

The use of an external bias supply (via D5 and R5) is recommended to give the lowest device dissipation and highest efficiency however these components may be omitted if desired. This ability to be self powered provides improved phase angle dimming performance as the IC is able to maintain operation even when the input conduction phase angle is very small giving a low equivalent input voltage.

Capacitor C4 also selects the output power mode, 10  $\mu$ F was selected (reduced power mode) to minimize the device dissipation and minimize heat sinking requirements.

### **4.3 Feedback**

The bias winding voltage is used to sense the output voltage indirectly, eliminating secondary side feedback components. The voltage on the bias winding is proportional to the output voltage (set by the turns ratio between the bias and secondary windings). Resistor R6 converts the bias voltage into a current which is fed into the FEEDBACK (FB) pin of U1. The internal engine within U1 combines the FB pin current, V pin current and drain current information to provide a constant output current over a 2:1 output voltage range whilst maintaining high input power factor.

To limit the output voltage at no-load an output overvoltage clamp is set by D7, C12, R20, VR3, C13, Q3 and R19. Should the output load be disconnected then the bias voltage will increase until VR3 conducts, turning on Q3 and reducing the current into the FB pin. When this current drops below 20  $\mu$ A the part enters auto-restart and switching is disabled for 800 ms allowing time for the output (and bias) voltages to fall.



#### **4.4 Output Rectification**

The transformer secondary winding is rectified by D8 and filtered by C8 and C10. A Schottky barrier diode was selected for efficiency and the combined value of C8 and C10 was selected to give an LED ripple current equal to 40% of the mean value. For designs where lower ripple is desirable the output capacitance value can be increased. A small pre-load is provided by R15 which limits the output voltage under no-load conditions.

#### **4.5 TRIAC Phase Dimming Control Compatibility**

The requirement to provide output dimming with low cost, TRIAC base, leading edge phase dimmers introduced a number of trade offs in the design.

Due to the much lower power consumed by LED based lighting the current drawn by the overall lamp is below the holding current of the TRIAC within the dimmer. This causes undesirable behaviors such as limited dim range and/or flickering as the TRIAC fires inconsistently. The relatively large impedance the LED lamp presents to the line allows significant ringing to occur due to the inrush current charging the input capacitance when the TRIAC turns on. This too can cause similar undesirable behavior as the ringing may cause the TRIAC current to fall to zero and turn off.

To overcome these issues two circuits the Active Damper and Passive Bleeder were incorporated. The drawback of these circuits is increased dissipation and therefore reduced efficiency of the supply. For non-dimming application these components can simply be omitted.

The Active Damper consists of components R9, R10, R11, R12, D1, Q1, C6, VR2, Q2 in conjunction with R13. This circuit limits the inrush current that flows to charge C2 when the TRIAC turns on by placing R13 in series for the first 1 ms of the conduction period. After approximately 1 ms, Q2 turns on and shorts R13. This keeps the power dissipation on R13 low and allows a larger value during current limiting. Resistor R9, R10, R11 and C6 provide the 1 ms delay after the TRIAC conducts. Transistor Q1 discharges C6 when the TRIAC is not conducting; VR2 clamps the gate voltage of Q2 to 15 V while R12 prevents MOSFET oscillation.

The Passive Bleeder circuit is comprised of C11 and R18. This keeps the input current above the TRIAC holding current while the input current corresponding to the driver increases during each AC half cycle preventing the TRIAC oscillating on and off at the start of each conduction angle period.

This arrangement provided flicker-free dimming operation with all the phase angle dimmers tested including units from Europe, China, Korean and both leading and lagging edge types.



### 5 PCB Layout

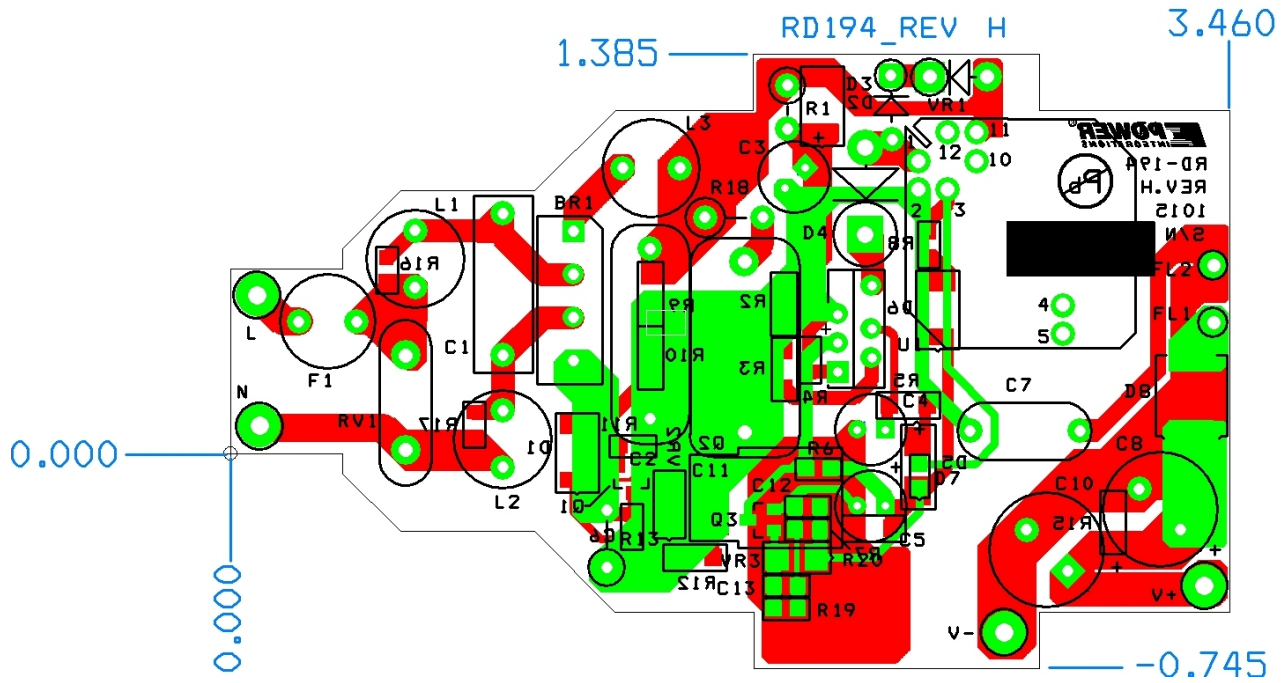


Figure 4 – Printed Circuit Layout.



## 6 Bill of Materials

### 6.1 Electrical

Item	Qty	Ref Des	Description	Mfg Part Number	Mfg
1	1	BR1	600 V, 2 A, Bridge Rectifier, Glass Passivated	2KBP06M-E4/51	Vishay
2	1	C1	47 nF, 275 VAC, Film, X2	ECQU2A473ML	Panasonic
3	1	C2	100 nF, 630 V, Film	ECQ-E6104KF	Panasonic
4	1	C3	1 $\mu$ F, 400 V, Electrolytic, (6.3 x 11)	EKMG401ELL1R0MF11D	United Chemi-Con
5	1	C4	10 $\mu$ F, 16 V, Electrolytic, Gen. Purpose, (5 x 11)	EKMG160ELL100ME11D	United Chemi-Con
6	1	C5	22 $\mu$ F, 50 V, Electrolytic, Low ESR, 900 m $\Omega$ , (5 x 11.5)	ELXZ500ELL220MEB5D	Nippon Chemi-Con
7	1	C6	15 nF, 50 V, Ceramic, X7R, 0805	ECJ-2VB1H153K	Panasonic
8	1	C7	2.2 nF, Ceramic, Y1	440LD22-R	Vishay
9	2	C8 C10	330 $\mu$ F, 50 V, Electrolytic, Very Low ESR, 28 m $\Omega$ , (10 x 25)	EKZE500ELL331MJ25S	Nippon Chemi-Con
10	1	C11	220 nF, 630 V, Film	ECQ-E6224KF	Panasonic
11	1	C12	1 $\mu$ F, 50 V, Ceramic, X7R, 0805	08055D105KAT2A	AVX Corporation
12	1	C13	100 nF, 50 V, Ceramic, X7R, 0805	ECJ-2YB1H104K	Panasonic
13	1	D1	100 V, 1 A, Rectifier, Glass Passivated, DO-213AA (MELF)	DL4002-13-F	Diodes Inc
14	1	D2	1000 V, 1 A, Rectifier, Glass Passivated, DO-213AA (MELF)	DL4007-13-F	Diodes Inc
15	1	D3	1000 V, 1 A, Ultrafast Recovery, 75 ns, DO-41	UF4007-E3	Vishay
16	1	D4	200 V, 1 A, Ultrafast Recovery, 50 ns, DO-41	UF4003-E3	Vishay
17	1	D5	100 V, 1 A, Fast Recovery, 150 ns, SMA	RS1B-13-F	Diodes, Inc
18	1	D6	400V, 1 A, Rectifier, Fast Recovery, MELF (DL-41)	DL4936-13-F	Diodes Inc
19	1	D7	250 V, 0.2 A, Fast Switching, 50 ns, SOD-323	BAV21WS-7-F	Diode Inc.
20	1	D8	200 V, 4 A, Schottky, SMC, DO-214AB	MBRS4201T3G	ON Semiconductor
21	1	F1	3.15 A, 250 V, Slow, TR5	37213150411	Wickman
22	3	L1 L2 L3	1000 $\mu$ H, 0.3 A	RLB0914-102KL	Bourns
23	1	Q1	PNP, 400V 150MA, SOT-23	FMMT558TA	Zetex Inc
24	1	Q2	400 V, 1.7 A, 3.6 $\Omega$ , N-Channel, DPAK	IRFR310TRPBF	Vishay
25	1	Q3	NPN, Small Signal BJT, 40 V, 0.2 A, SOT-23	MMBT3904LT1G	On Semiconductor
26	1	R1	240 k $\Omega$ , 5%, 1/2 W, Carbon Film	CFR-50JB-240K	Yageo
27	2	R2 R3	2.00 M $\Omega$ , 1%, 1/4 W, Thick Film, 1206	ERJ-8ENF2004V	Panasonic
28	1	R4	49.9 k $\Omega$ , 1%, 1/8 W, Thick Film, 0805	ERJ-6ENF4992V	Panasonic
29	1	R5	3 k $\Omega$ , 5%, 1/4 W, Thick Film, 1206	ERJ-8GEYJ302V	Panasonic
30	1	R6	150 k $\Omega$ , 1%, 1/8 W, Thick Film, 0805	ERJ-6ENF1503V	Panasonic
31	1	R7	10 k $\Omega$ , 5%, 1/4 W, Thick Film, 1206	ERJ-8GEYJ103V	Panasonic
32	1	R8	150 $\Omega$ , 5%, 1/8 W, Thick Film, 0805	ERJ-6GEYJ151V	Panasonic
33	2	R9 R10	750 k $\Omega$ , 1%, 1/4 W, Thick Film, 1206	ERJ-8ENF7503V	Panasonic
34	1	R11	2.4 M $\Omega$ , 5%, 1/8 W, Thick Film, 0805	ERJ-6GEYJ245V	Panasonic
35	1	R12	15 $\Omega$ , 5%, 1/8 W, Thick Film, 0805	ERJ-6GEYJ150V	Panasonic
36	1	R13	130 $\Omega$ , 5%, 1/2 W, Carbon Film	CFR-50JB-130R	Yageo



37	1	R15	20 k $\Omega$ , 5%, 1/4 W, Thick Film, 1206	ERJ-8GEYJ203V	Panasonic
38	3	R16 R17 R19	1 k $\Omega$ , 5%, 1/8 W, Thick Film, 0805	ERJ-6GEYJ102V	Panasonic
39	1	R18	510 $\Omega$ , 5%, 1 W, Metal Oxide	RSF100JB-510R	Yageo
40	1	R20	10 k $\Omega$ , 5%, 1/8 W, Thick Film, 0805	ERJ-6GEYJ103V	Panasonic
41	1	RV1	275 V, 80J, 10 mm, RADIAL	ERZ-V10D431	Panasonic
42	1	T1	Custom Transformer, RM8,12pins	SNX-R1523	Santronics USA
43	1	U1	LinkSwitch, LNK406EG, eSIP	LNK406EG	Power Integrations
44	1	VR1	200 V, 1500W, TVS, GP-20	1.5KE200A-E3/54	Vishay
45	1	VR2	15 V, 5%, 500 mW, DO-213AA (MELF)	ZMM5245B-7	Diodes Inc
46	1	VR3	39 V, 5%, 500 mW, DO-213AA (MELF)	ZMM5259B-7	Diodes Inc

## 6.2 Mechanical

Item	Qty	Ref Des	Description	Mfg Part Number	Mfg
47	2	FL1 FL2	PCB Terminal Hole, 22 AWG	N/A	N/A
48	1	L	Test Point, WHT, THRU-HOLE MOUNT	5012	Keystone
49	2	N V-	Test Point, BLK, THRU-HOLE MOUNT	5011	Keystone
50	1	V+	Test Point, RED, THRU-HOLE MOUNT	5010	Keystone



## 7 Transformer Specification

### 7.1 Electrical Diagram

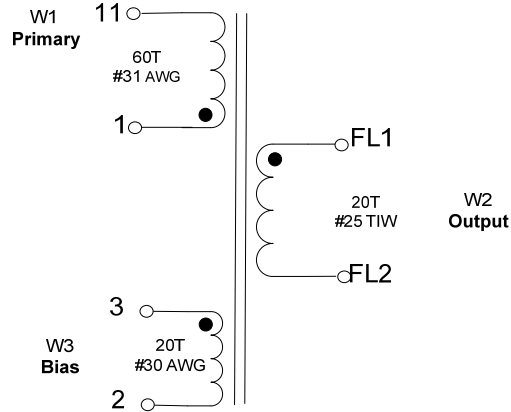


Figure 5 – Transformer Electrical Diagram.

### 7.2 Electrical Specifications

<b>Electrical Strength</b>	1 second, 60 Hz, from pins 1,2,3,11 to FL1 ,FL2	3000 VAC
<b>Primary Inductance</b>	Pins 1-11, all other windings open, measured at 100 kHz, 0.4 VRMS	1150 $\mu$ H, $\pm$ 20 %
<b>Resonant Frequency</b>	Pins 1-11, all other windings open	750 kHz (Min.)
<b>Primary Leakage Inductance</b>	Pins 1-11, with FL1-FL2 shorted, measured at 100 kHz, 0.4 VRMS	20 $\mu$ H (Max.)

### 7.3 Materials

Item	Description
[1]	Core: RM8/I, 3F3, ALG = 319 nH/n <sup>2</sup>
[2]	Bobbin: 12 pin vertical, CSV-RM8-1S-12P from Philips or equivalent with mounting clip, CLI/P-RM8
[3]	Tape: Polyester film, 3M 1350F-1 or equivalent, 9 mm wide
[4]	Wire: Magnet, #31 AWG, solderable double coated
[5]	Wire: Magnet, #30 AWG, solderable double coated
[6]	Wire: Triple Insulated, Furukawa TEX-E or Equivalent, #25 TIW
[7]	Transformer Varnish: Dolph BC-359 or equivalent



### 7.4 Transformer Build Diagram

**Pins Side**

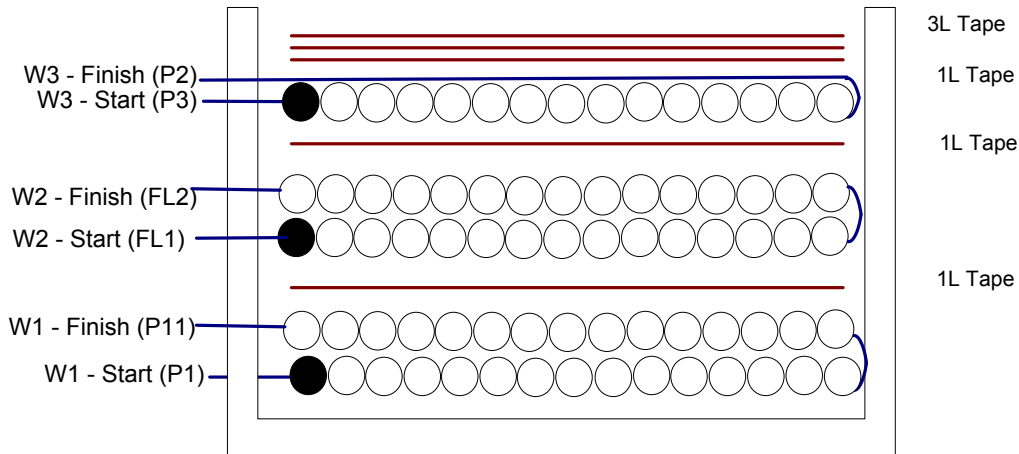


Figure 6 – Transformer Build Diagram.

### 7.5 Transformer Construction

<b>Bobbin Preparation</b>	Place the bobbin item [2] on the mandrel such that pin side on the left side. Winding direction is the clockwise direction.
<b>WD 1 (Primary)</b>	Starting at pin 1, wind 60 turns of wire item [4] in two layers. Finish at pin 11.
<b>Insulation</b>	Apply one layer of tape item [3].
<b>WD 2 (Secondary)</b>	Leave about 1" of wire item [6], use small tape to mark as FL1, enter into slot of secondary side of bobbin, wind 20 turns in two layers. At the last turn exit the same slot, leave about 1", and mark as FL2.
<b>Insulation</b>	Apply one layer of tape item [3].
<b>WD 3 (Bias)</b>	Starting at pin 3, wind 20 turns of wire item [5], spreading the wire, finish at pin 2.
<b>Finish Wrap</b>	Apply three layers of tape item [3] for finish wrap.
<b>Final Assembly</b>	Cut FL1 and FL2 to 0.75". Grind core to get 1.15 mH inductance value. Assemble and secure core halves. Dip impregnate using varnish item [7].





## 8 Transformer Design Spreadsheet

ACDC_LinkSwitch-PH_042910; Rev.1.0; Copyright Power Integrations 2010	INPUT	INFO	OUTPUT	UNIT	LinkSwitch-PH_042910: Flyback Transformer Design Spreadsheet
<b>ENTER APPLICATION VARIABLES</b>					
Dimming required	YES	Info	YES		!!! Info. When configured for dimming, best output current line regulation is achieved over a single input voltage range.
VACMIN			90	V	Minimum AC Input Voltage
VACMAX	265		265	V	Maximum AC input voltage
fL			50	Hz	AC Mains Frequency
VO	28.00			V	Typical output voltage of LED string at full load
VO_MAX			30.80	V	Maximum expected LED string Voltage.
VO_MIN			25.20	V	Minimum expected LED string Voltage.
V_OVP			33.88	V	Over-voltage protection setpoint
IO	0.50				Typical full load LED current
PO			14.0	W	Output Power
n			0.8		Estimated efficiency of operation
VB	28		28	V	Bias Voltage
<b>ENTER LinkSwitch-PH VARIABLES</b>					
LinkSwitch-PH	LNK406			Universal	115 Doubled/230V
Chosen Device		LNK406	Power Out	22.5W	22.5W
Current Limit Mode	RED		RED		Select "RED" for reduced Current Limit mode or "FULL" for Full current limit mode
ILIMITMIN			1.19	A	Minimum current limit
ILIMITMAX			1.36	A	Maximum current limit
fS			66000	Hz	Switching Frequency
fSmin			62000	Hz	Minimum Switching Frequency
fSmax			70000	Hz	Maximum Switching Frequency
IV			39.9	uA	V pin current
RV			4	M-ohms	Upper V pin resistor
RV2			1E+12	M-ohms	Lower V pin resistor
IFB			158.8	uA	FB pin current (85 uA < IFB < 210 uA)
RFB1			157.5	k-ohms	FB pin resistor
VDS			10	V	LinkSwitch-PH on-state Drain to Source Voltage
VD	0.50			V	Output Winding Diode Forward Voltage Drop (0.5 V for Schottky and 0.8 V for PN diode)
VDB	0.70			V	Bias Winding Diode Forward Voltage Drop
<b>Key Design Parameters</b>					
KP	0.87		0.87		Ripple to Peak Current Ratio (For PF > 0.9, 0.4 < KP < 0.9)
LP			1150	uH	Primary Inductance
VOR	85.00		85	V	Reflected Output Voltage.
Expected IO (average)			0.51	A	Expected Average Output Current



KP_VACMAX			1.11		Expected ripple current ratio at VACMAX
TON_MIN			1.86	us	Minimum on time at maximum AC input voltage
<b>ENTER TRANSFORMER CORE/CONSTRUCTION VARIABLES</b>					
<b>Core Type</b>	<b>RM8/I</b>		<b>RM8/I</b>		
Bobbin		<i>RM8/I_BOBBIN</i>		<i>P/N:</i>	*
AE			0.63	cm <sup>2</sup>	Core Effective Cross Sectional Area
LE			3.84	cm	Core Effective Path Length
AL			3000	nH/T <sup>2</sup>	Ungapped Core Effective Inductance
BW			10	mm	Bobbin Physical Winding Width
M			0	mm	Safety Margin Width (Half the Primary to Secondary Creepage Distance)
L	2.00		2		Number of Primary Layers
NS	20		20		Number of Secondary Turns
<b>DC INPUT VOLTAGE PARAMETERS</b>					
VMIN			127	V	Peak input voltage at VACMIN
VMAX			375	V	Peak input voltage at VACMAX
<b>CURRENT WAVEFORM SHAPE PARAMETERS</b>					
DMAX			0.42		Minimum duty cycle at peak of VACMIN
I AVG			0.51	A	Average Primary Current
IP			0.95	A	Peak Primary Current (calculated at minimum input voltage VACMIN)
IRMS			0.31	A	Primary RMS Current (calculated at minimum input voltage VACMIN)
<b>TRANSFORMER PRIMARY DESIGN PARAMETERS</b>					
LP			1150	uH	Primary Inductance
NP			60		Primary Winding Number of Turns
NB			20		Bias Winding Number of Turns
ALG			323	nH/T <sup>2</sup>	Gapped Core Effective Inductance
BM			2897	Gauss	Maximum Flux Density at PO, VMIN (BM<3100)
BP			3506	Gauss	Peak Flux Density (BP<3700)
BAC			1267	Gauss	AC Flux Density for Core Loss Curves (0.5 X Peak to Peak)
ur			1455		Relative Permeability of Ungapped Core
LG			0.22	mm	Gap Length (Lg > 0.1 mm)
BWE			20	mm	Effective Bobbin Width
OD			0.34	mm	Maximum Primary Wire Diameter including insulation
INS			0.06	mm	Estimated Total Insulation Thickness (= 2 * film thickness)
DIA			0.28	mm	Bare conductor diameter
AWG			30	AWG	Primary Wire Gauge (Rounded to next smaller standard AWG value)
CM			102	Cmils	Bare conductor effective area in circular mils
CMA			330	Cmils/Amp	Primary Winding Current Capacity (200 < CMA < 600)
<b>TRANSFORMER SECONDARY DESIGN PARAMETERS (SINGLE OUTPUT EQUIVALENT)</b>					
<b>Lumped parameters</b>					
ISP			2.82	A	Peak Secondary Current
ISRMS			1.01	A	Secondary RMS Current
IRIPPLE			0.88	A	Output Capacitor RMS Ripple Current



CMS			203	Cmils	Secondary Bare Conductor minimum circular mils
AWGS			27	AWG	Secondary Wire Gauge (Rounded up to next larger standard AWG value)
DIAS			0.36	mm	Secondary Minimum Bare Conductor Diameter
ODS			0.50	mm	Secondary Maximum Outside Diameter for Triple Insulated Wire
<b>VOLTAGE STRESS PARAMETERS</b>					
VDRAIN			553	V	Estimated Maximum Drain Voltage assuming maximum LED string voltage (Includes Effect of Leakage Inductance)
PIVS			160	V	Output Rectifier Maximum Peak Inverse Voltage (calculated at VOVP, excludes leakage inductance spike)
PIVB			160	V	Bias Rectifier Maximum Peak Inverse Voltage (calculated at VOVP, excludes leakage inductance spike)
<b>FINE TUNING (Enter measured values from prototype)</b>					
<b>V pin Resistor Fine Tuning</b>					
RV1			4.00	M-ohms	Upper V Pin Resistor Value
RV2			1E+12	M-ohms	Lower V Pin Resistor Value
VAC1			115.0	V	Test Input Voltage Condition1
VAC2			230.0	V	Test Input Voltage Condition2
IO_VAC1			0.50	A	Measured Output Current at VAC1
IO_VAC2			0.50	A	Measured Output Current at VAC2
RV1 (new)			4.00	M-ohms	New RV1
RV2 (new)			20911.63	M-ohms	New RV2
V_OV			319.6	V	Typical AC input voltage at which OV shutdown will be triggered
V_UV			66.3	V	Typical AC input voltage beyond which power supply can startup
<b>FB pin resistor Fine Tuning</b>					
RFB1			157	k-ohms	Upper FB Pin Resistor Value
RFB2			1E+12	k-ohms	Lower FB Pin Resistor Value
VB1			25.2	V	Test Bias Voltage Condition1
VB2			30.8	V	Test Bias Voltage Condition2
IO1			0.50	A	Measured Output Current at Vb1
IO2			0.50	A	Measured Output Current at Vb2
RFB1 (new)			157.5	k-ohms	New RFB1
RFB2(new)			1.00E+12	k-ohms	New RFB2



## 9 Performance Data

All measurements performed at room temperature

### 9.1 Power Efficiency

#### 9.1.1 28 V

Hz	V <sub>IN</sub> (VAC)	P <sub>IN</sub> (W)	V <sub>OUT</sub> (V)	I <sub>OUT</sub> (mA)	P <sub>OUT</sub> (W)	Efficiency (%)	PF
60	90	14.62	27.78	439	12.20	83	
60	100	15.1	27.85	455	12.67	84	
60	115	15.78	27.99	477	13.35	85	0.98
60	130	16.34	28.11	497	13.97	85	
Hz	V <sub>IN</sub> (VAC)	P <sub>IN</sub> (W)	V <sub>OUT</sub> (V)	I <sub>OUT</sub> (mA)	P <sub>OUT</sub> (W)	Efficiency (%)	PF
50	185	18.31	28.47	558	15.89	87	
50	200	18.79	28.54	571	16.30	87	
50	215	19.23	28.6	584	16.70	87	
50	230	19.67	28.67	596	17.09	87	0.93
50	245	20.08	28.73	607	17.44	87	
50	265	20.63	28.81	621	17.89	87	

#### 9.1.2 25 V

Hz	V <sub>IN</sub> (VAC)	P <sub>IN</sub> (W)	V <sub>OUT</sub> (V)	I <sub>OUT</sub> (mA)	P <sub>OUT</sub> (W)	Efficiency (%)	PF
60	90	13.22	24.95	440	10.98	83	
60	100	13.67	25.04	458	11.47	84	
60	115	14.27	25.16	481	12.10	85	0.98
60	130	14.83	25.28	501	12.67	85	
Hz	V <sub>IN</sub> (VAC)	P <sub>IN</sub> (W)	V <sub>OUT</sub> (V)	I <sub>OUT</sub> (mA)	P <sub>OUT</sub> (W)	Efficiency (%)	PF
50	185	16.62	25.58	561	14.35	86	
50	200	17.05	25.64	575	14.74	86	
50	215	17.46	25.71	588	15.12	87	
50	230	17.86	25.77	600	15.46	87	0.92
50	245	18.24	25.82	611	15.78	86	
50	265	18.73	25.88	625	16.18	86	



9.1.3 31 V

Hz	V <sub>IN</sub> (VAC)	P <sub>IN</sub> (W)	V <sub>OUT</sub> (V)	I <sub>OUT</sub> (mA)	P <sub>OUT</sub> (W)	Efficiency (%)	PF
60	90	16.35	30.82	437	13.47	82	
60	100	16.89	30.97	454	14.06	83	
60	115	17.53	31.12	476	14.81	85	0.98
60	130	18.14	31.25	495	15.47	85	
Hz	V <sub>IN</sub> (VAC)	P <sub>IN</sub> (W)	V <sub>OUT</sub> (V)	I <sub>OUT</sub> (mA)	P <sub>OUT</sub> (W)	Efficiency (%)	PF
50	185	20.49	31.75	560	17.78	87	
50	200	20.91	31.8	571	18.16	87	
50	215	21.4	31.88	583	18.59	87	
50	230	21.86	31.95	595	19.01	87	0.93
50	245	22.34	32.02	606	19.40	87	
50	265	22.93	32.11	620	19.91	87	

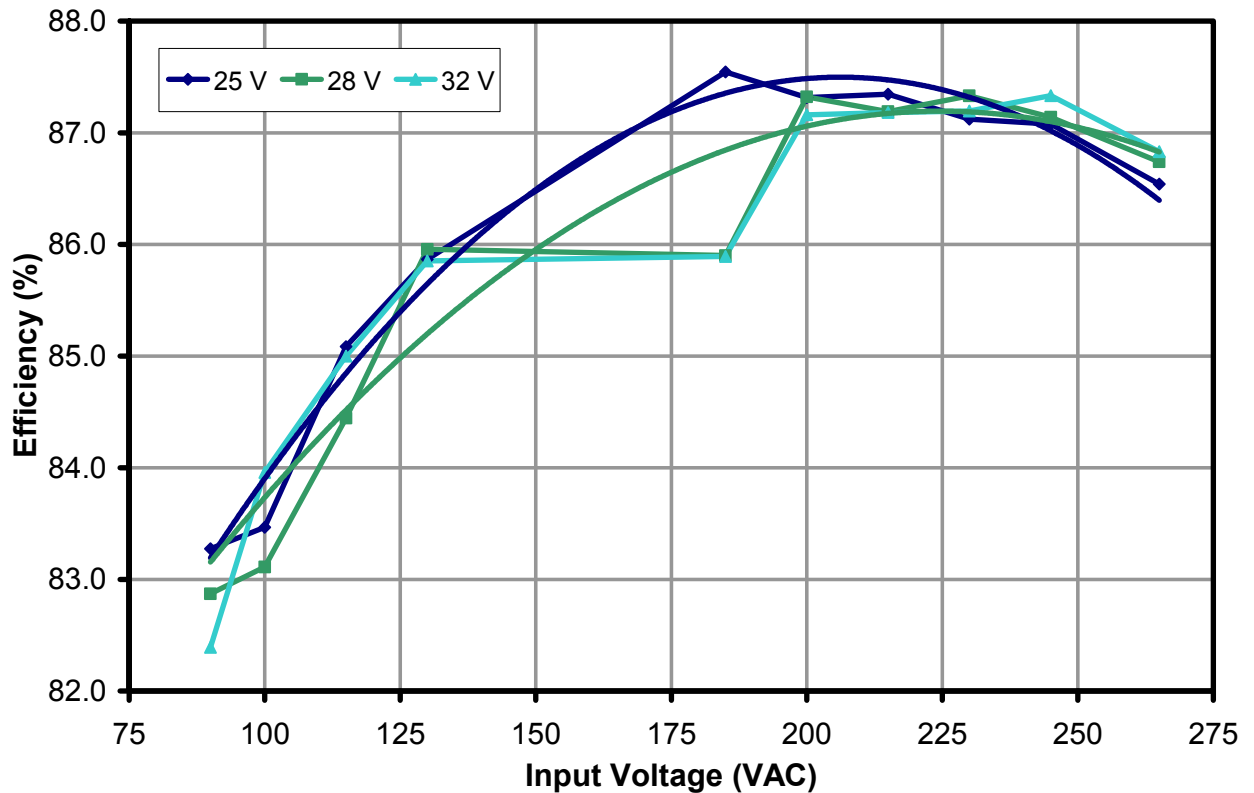
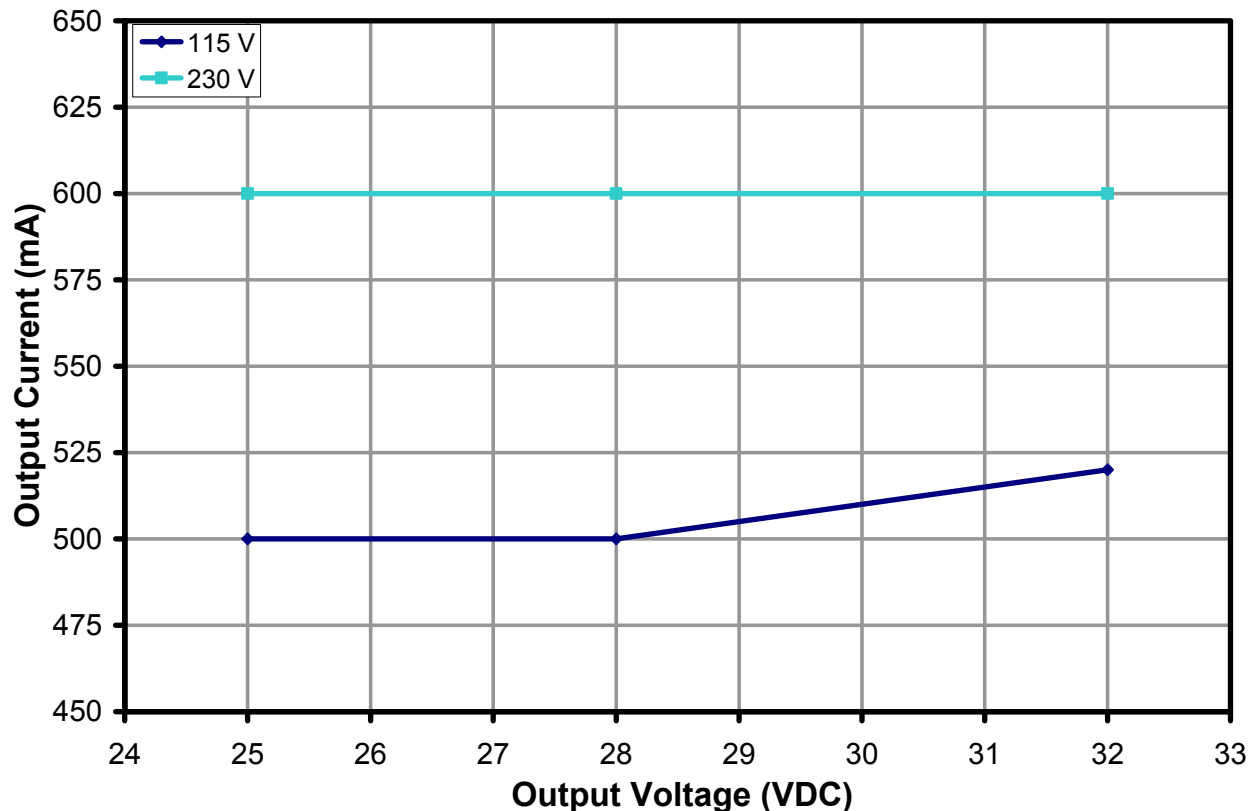


Figure 7– Efficiency vs. Input Voltage, Room Temperature.



## 9.2 Regulation

### 9.2.1 Output Voltage and Line



**Figure 8** – Voltage and Line Regulation, Room Temperature.

The line regulation result shown above is typical for a design where the phase angle dimming mode of U1 is selected (to provide a very wide dimming range). For a given line voltage the output current can be centered by changing the value of the FEEDBACK resistor (R6). The table below shows the resistor values to adjust the mean output current at specific input voltages,

Line Voltage (VAC)	Value of R6 (kΩ)
100	147
115	150
230	178

**Table 1** – Feedback Resistor Value to Center Output Current at Different Nominal Line Voltages.



### 9.2.2 Input Voltage and Output Voltage Regulation

Note: 28 V and 25 V data identical.

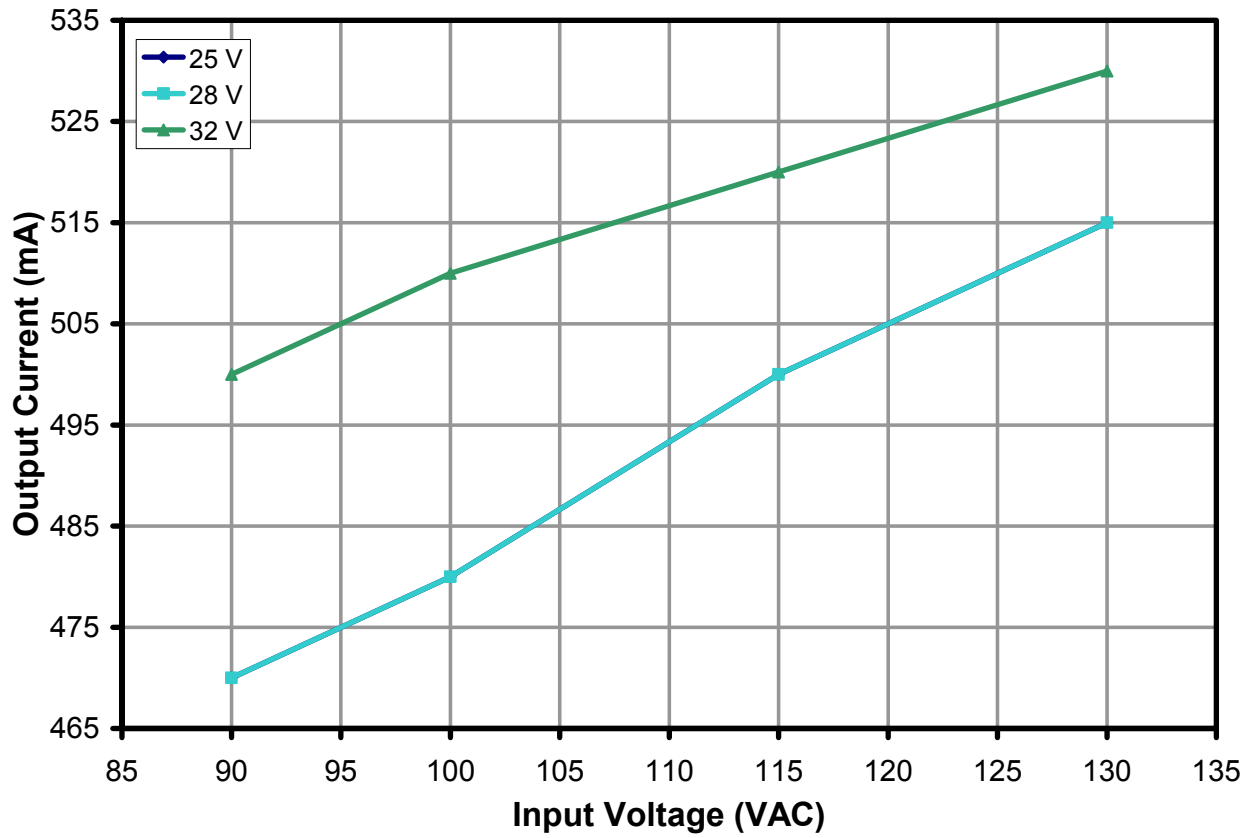


Figure 9 – Low Line Regulation, Room Temperature, Full Load.



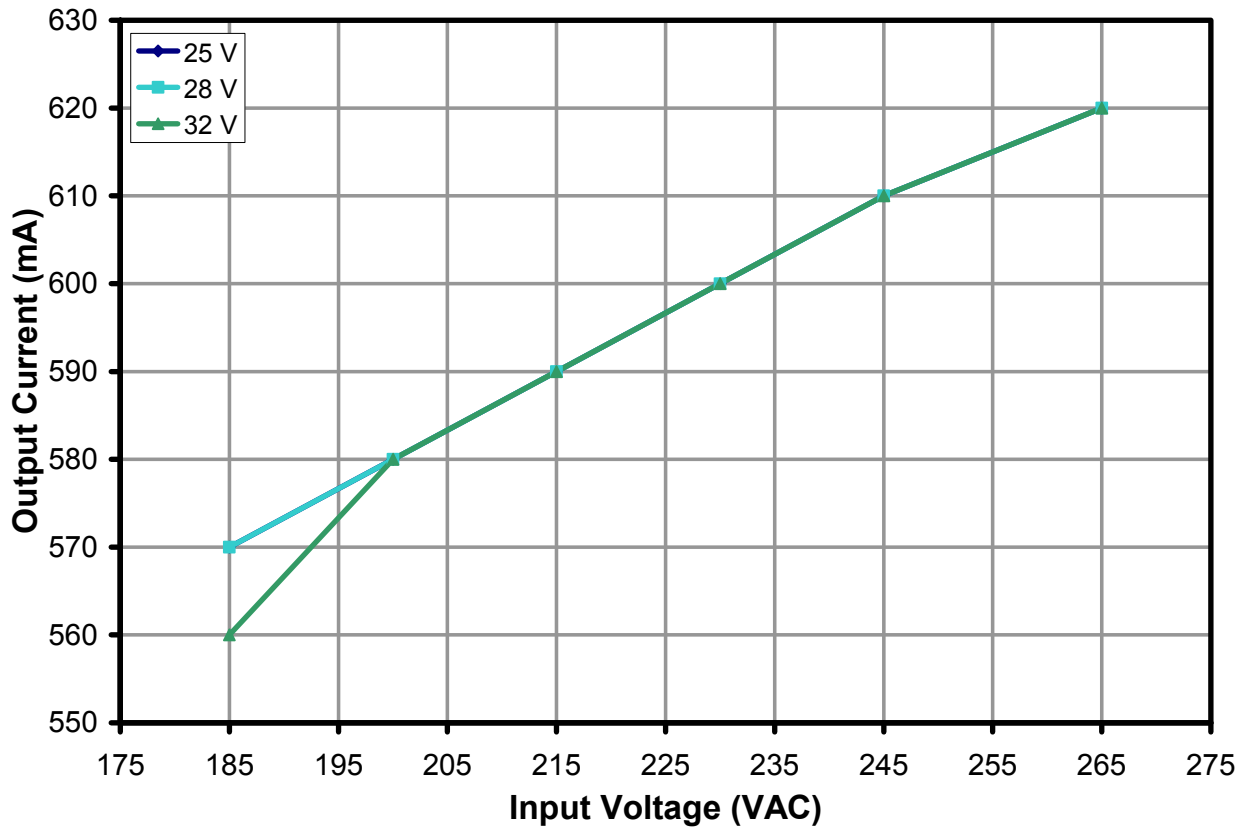


Figure 10 – High Line Regulation, Room Temperature, Full Load.





### 10 Thermal Performance

Images captured after running for 30 minutes at room temperature (25 °C), full load. This indicates an operating temperature of 100°C at 50°C for the LinkSwitch-PH. The addition of a small heat sink (width of board) to the device reduces the operating temperature by ~25°C.

#### 10.1 $V_{IN} = 115 \text{ VAC}$ (U1: No Heat Sink)

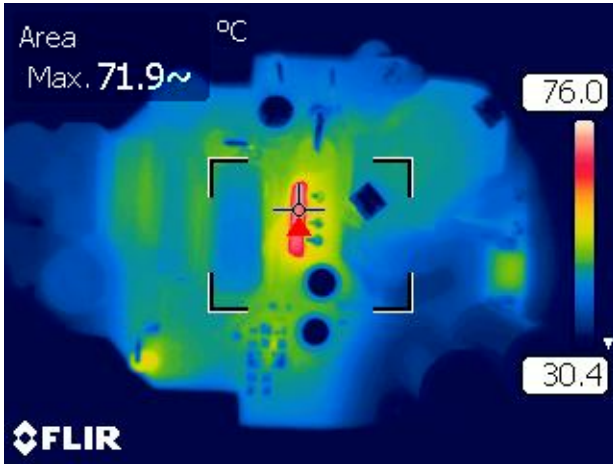


Figure 11 – Top Side.

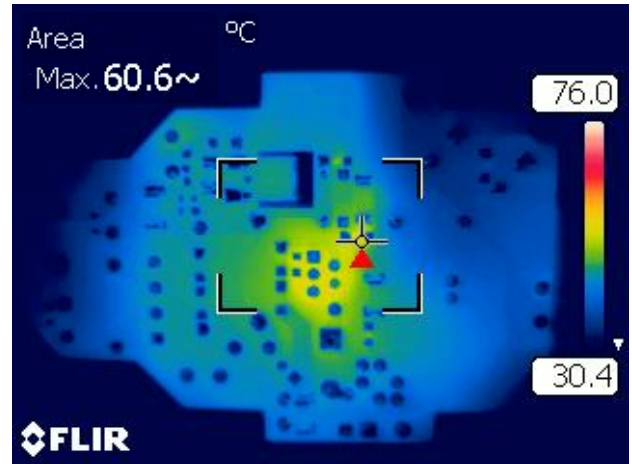


Figure 12 – Bottom Side.

#### 10.2 $V_{IN} = 230 \text{ VAC}$ (U1: No Heat Sink)

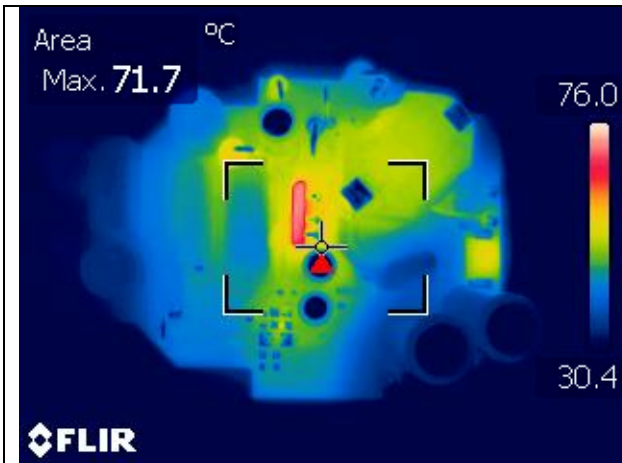


Figure 13 – Top Side.

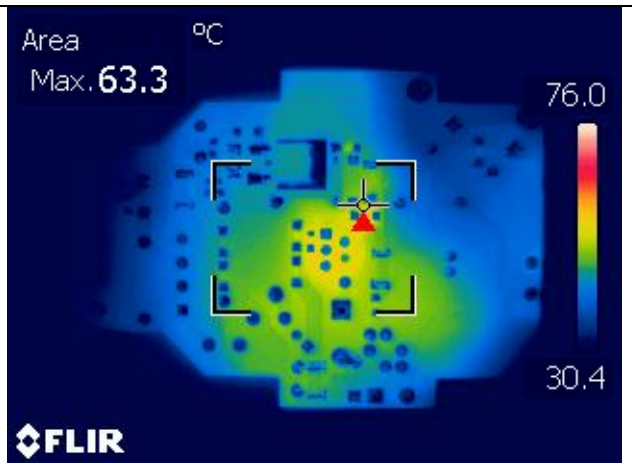


Figure 14 – Bottom Side.

### 11 Harmonic Data

Per IEC 61000-3-2 (2005) for Class C compliance for an active input power <25 W requires meeting Class D limits. Where Figures 15 and 16 show Class C Limits these are intended to show the limits for Class C compliance (Class D limits).

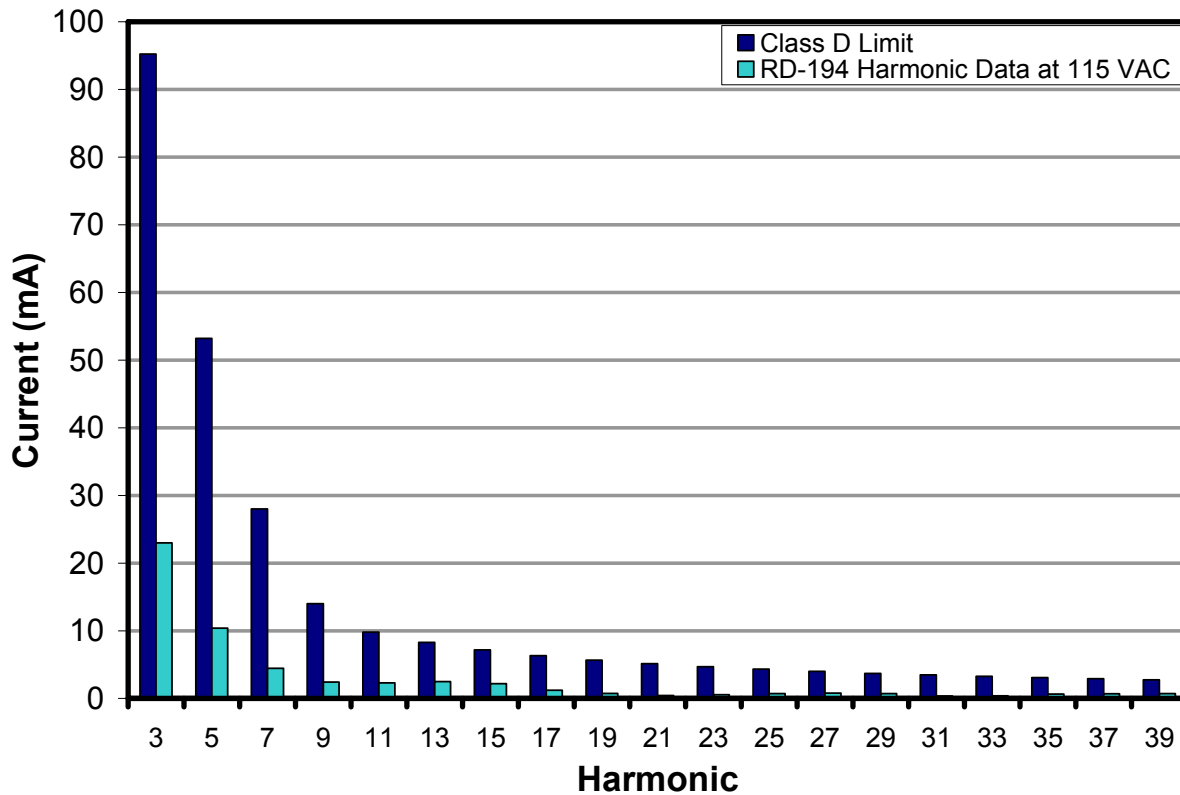


Figure 15 – 115 VAC Harmonic, Room Temperature, Full Load.



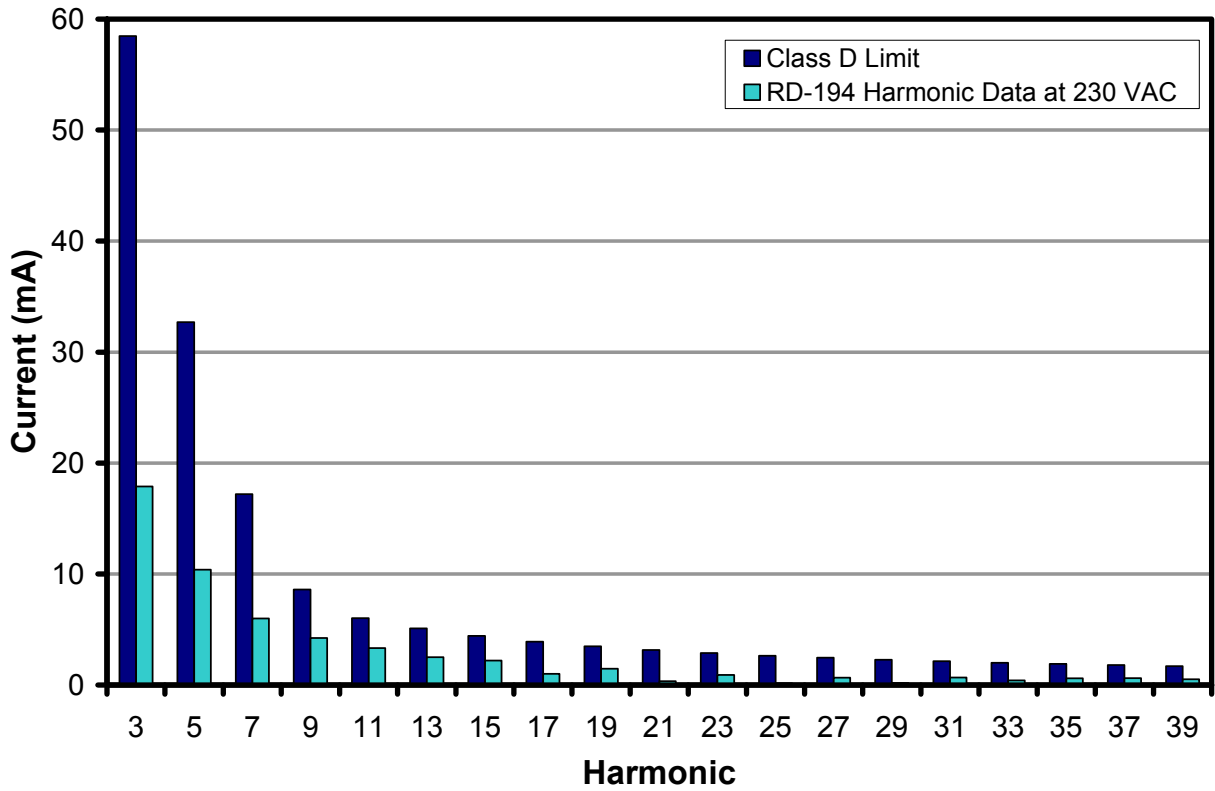


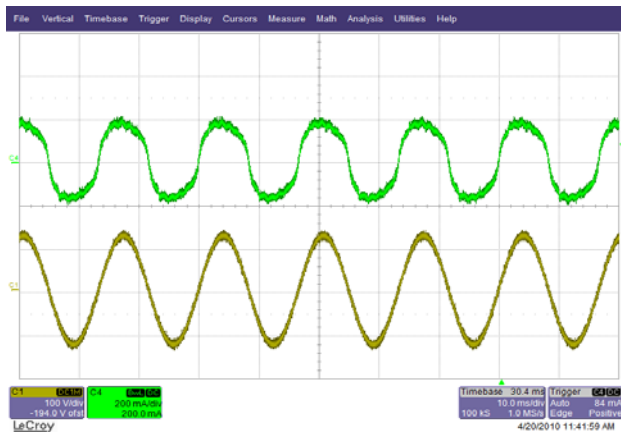
Figure 16 – 230 VAC Harmonic, Room Temperature, Full Load.

V <sub>IN</sub> = 115 VAC		
THD (%)	Limit (%)	Margin (%)
21.0	33	12.0
V <sub>IN</sub> = 230 VAC		
THD (%)	Limit (%)	Margin (%)
27.8	33	5.2

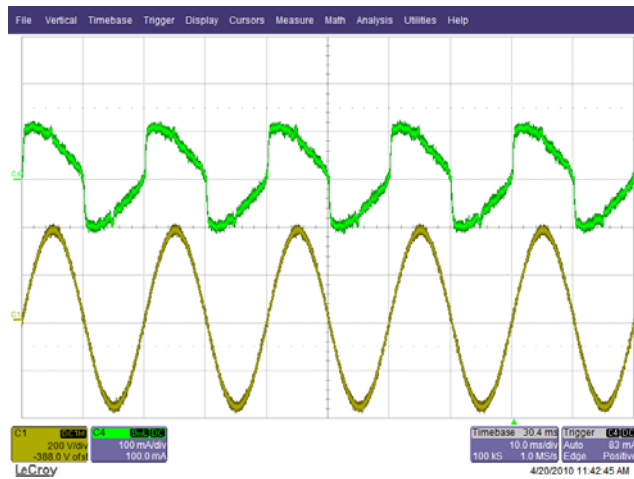


## 12 Waveforms

### 12.1 Input Line Voltage and Current

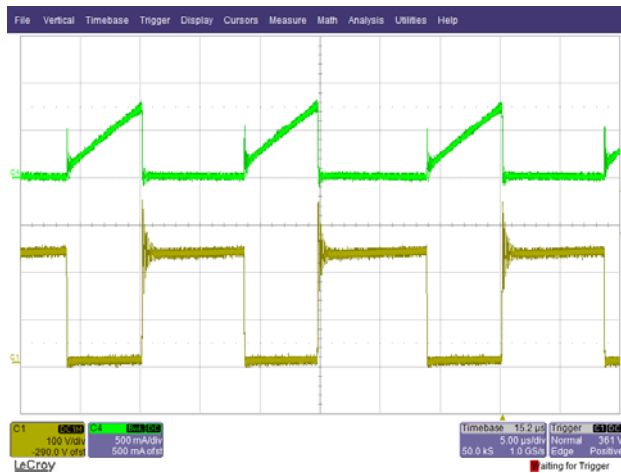


**Figure 17** – 90 VAC, Full Load.  
 Upper:  $I_{IN}$ , 0.2 A / div.  
 Lower:  $V_{IN}$ , 100 V, 10 ms / div.

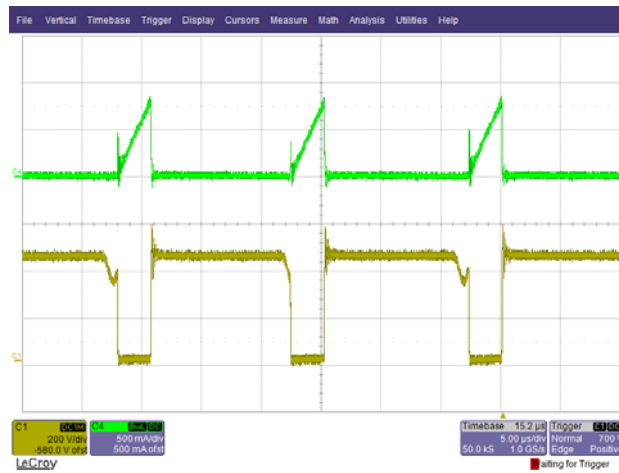


**Figure 18** – 265 VAC, Full Load.  
 Upper:  $I_{IN}$ , 0.1 A / div.  
 Lower:  $V_{IN}$ , 200 V / div., 10 ms / div.

### 12.2 Drain Voltage and Current



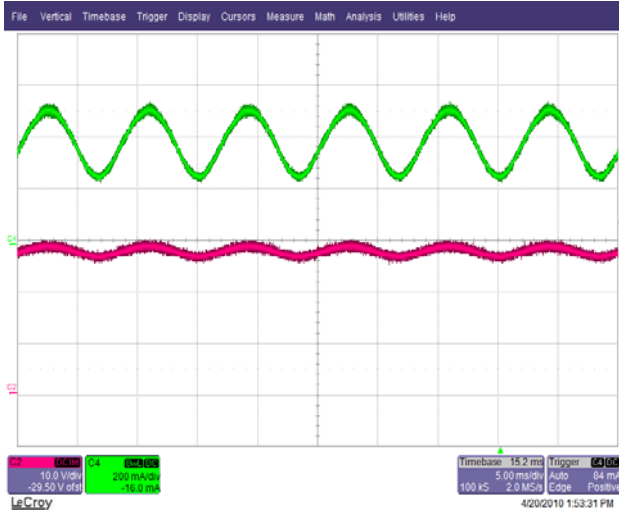
**Figure 19** – 90 VAC, Full Load.  
 Upper:  $I_{DRAIN}$ , 0.5 A / div.  
 Lower:  $V_{DRAIN}$ , 100 V, 5  $\mu$ s / div.



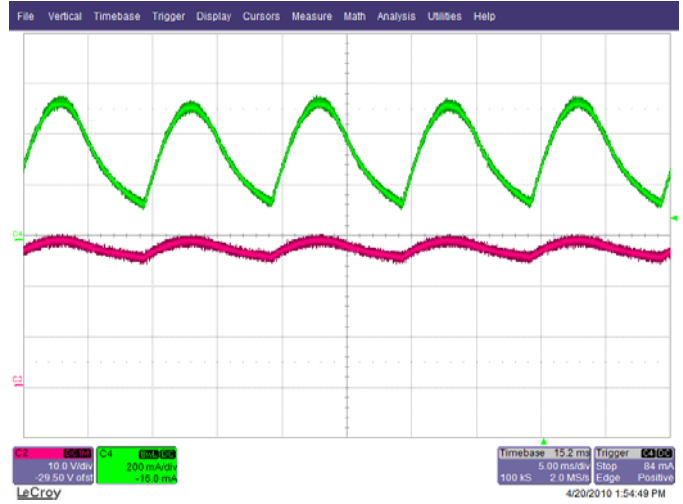
**Figure 20** – 265 VAC, Full Load.  
 Upper:  $I_{DRAIN}$ , 0.5 A / div.  
 Lower:  $V_{DRAIN}$ , 200 V / div., 5  $\mu$ s / div.



### 12.3 Output Voltage and Ripple Current

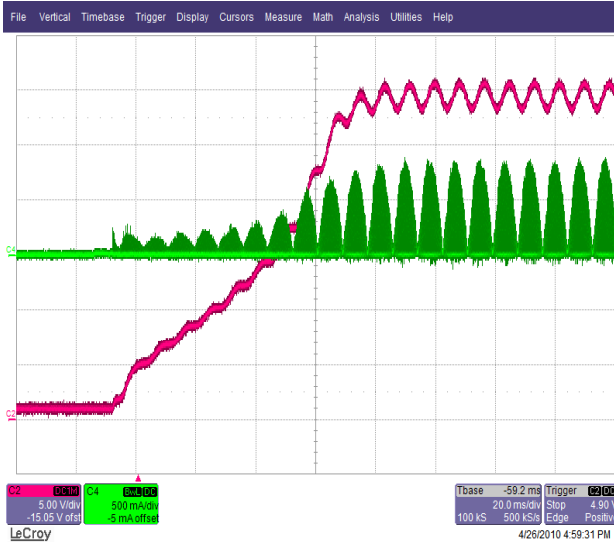


**Figure 21** – 90 VAC, Full Load.  
 Upper:  $I_{RIPPLE}$ , 0.2 A / div.  
 Lower:  $V_{OUTPUT}$  10 V, 5 ms / div.



**Figure 22** – 265 VAC, Full Load.  
 Upper:  $I_{RIPPLE}$ , 0.2 A / div.  
 Lower:  $V_{OUTPUT}$  10 V, 5 ms / div.

### 12.4 Output Voltage and Drain Current Start-up Profile



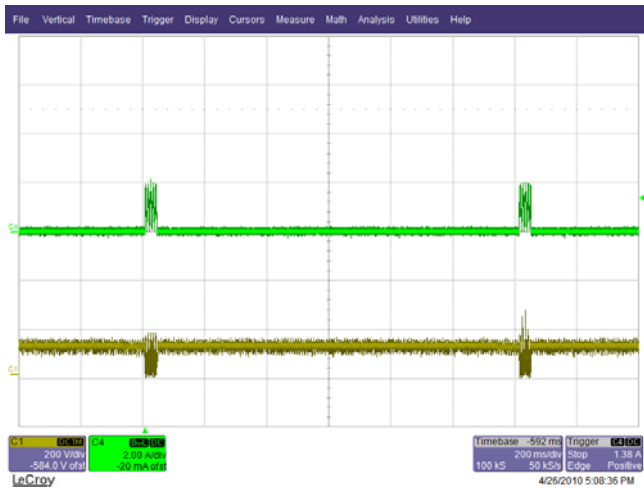
**Figure 23** – 90 VAC, Full Load.  
 Upper:  $I_{DRAIN}$ , 0.5 A / div.  
 Lower:  $V_{OUTPUT}$ , 5 V, 20 ms / div.



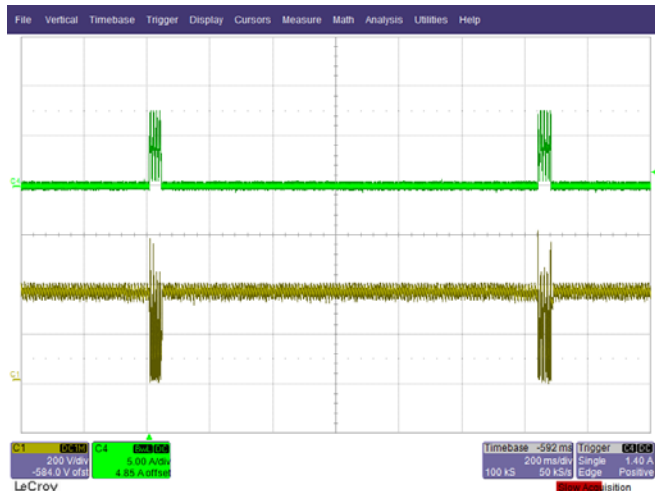
**Figure 24** – 265 VAC, Full Load.  
 Upper:  $I_{RIPPLE}$ , 0.5 A / div.  
 Lower:  $V_{OUTPUT}$ , 5 V, 10 ms / div.



### 12.5 Output Current and Drain Voltage During Shorted Output

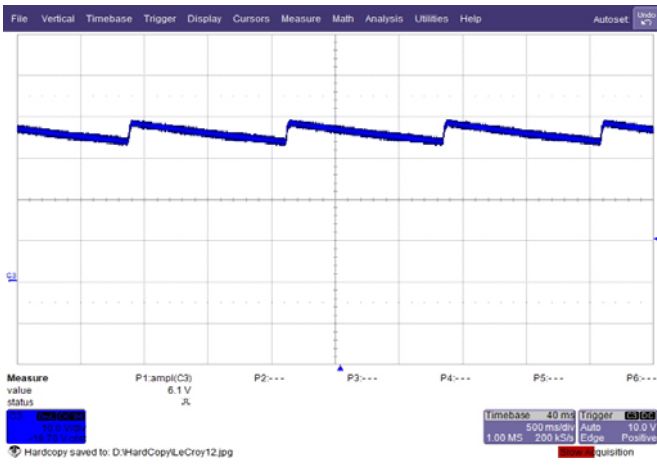


**Figure 25** – 90 VAC, Full Load.  
 Upper:  $I_{OUTPUT}$ , 2 A / div.  
 Lower:  $V_{DRAIN}$ , 200 V, 200 ms / div.

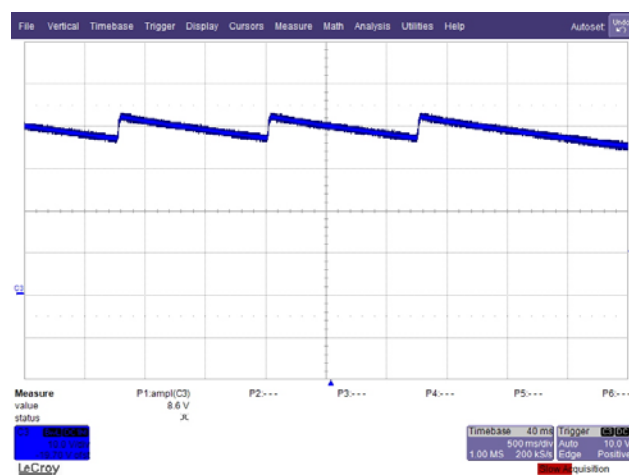


**Figure 26** – 265 VAC, Full Load.  
 Upper:  $I_{OUTPUT}$ , 5 A / div.  
 Lower:  $V_{OUTPUT}$ , 200 V, 200 ms / div.

### 12.6 Open Load Output Voltage



**Figure 27** – Output Voltage: 115 VAC.  
 $V_{OUT}$ , 10 V / div., 500 ms / div.



**Figure 28** – Output Voltage: 230 VAC.  
 $V_{OUT}$ , 10 V / div., 500 ms / div.



### 13 Dimming

#### 13.1 Input Phase vs. Output

Note: Due to operation of TRIAC based phase dimmers maximum conduction angle was limited to 165 deg.

115 VAC / 60 Hz		230 VAC / 50 Hz	
Phase Angle (°)	I <sub>OUT</sub> (mA)	Phase Angle (°)	I <sub>OUT</sub> (mA)
167	490	162	580
93	250	95	290
65	120	61	140
43	62	40	63
36	32	27	32
17	4	22	13
12	1.7	11	7
10	0.9	8	3
8	0.4	7	1.2

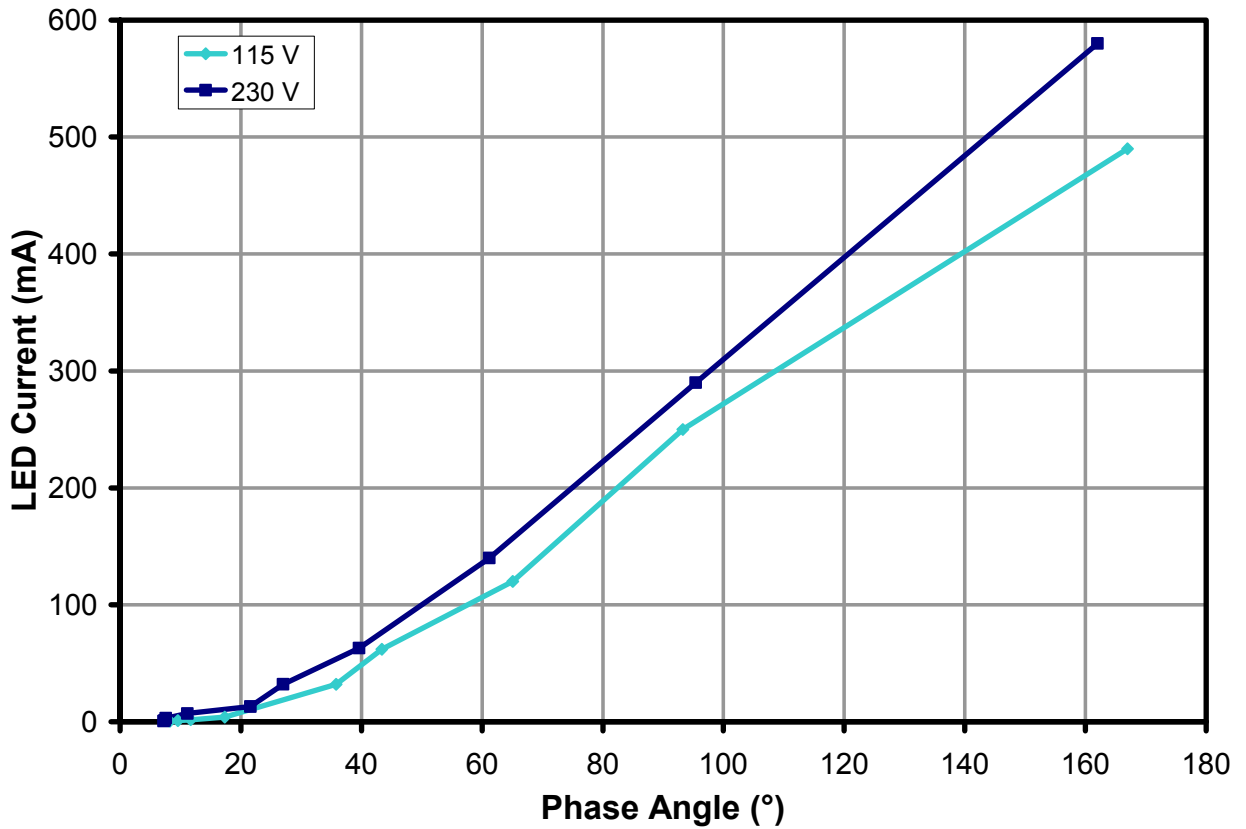
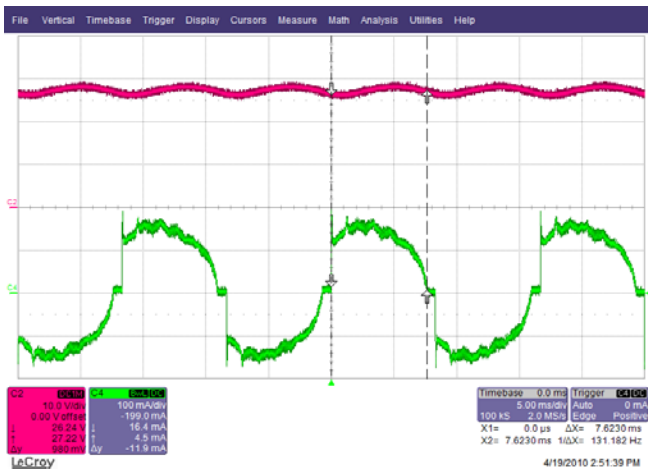


Figure 29 – Input Phase vs. Output Current.

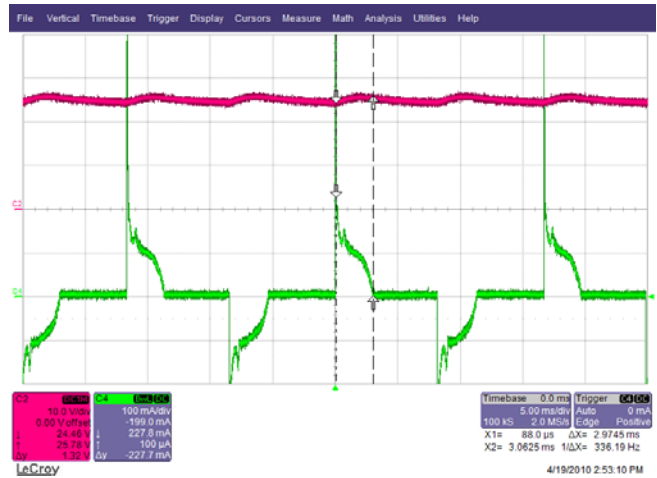


### 13.2 Output Voltage and Input Current Waveforms

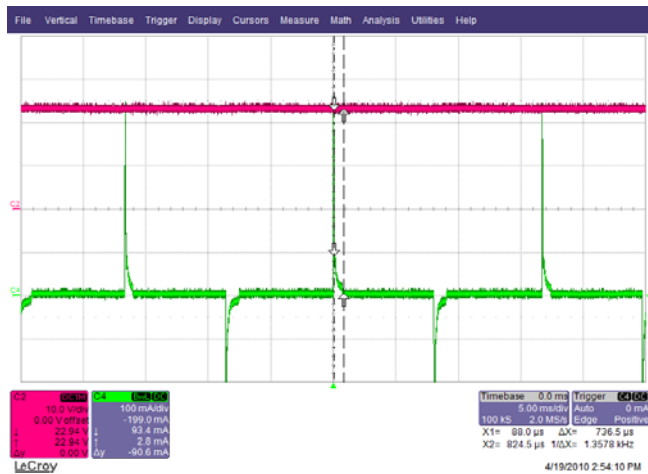
#### 13.2.1 $V_{IN} = 115 \text{ VAC} / 60 \text{ Hz}$



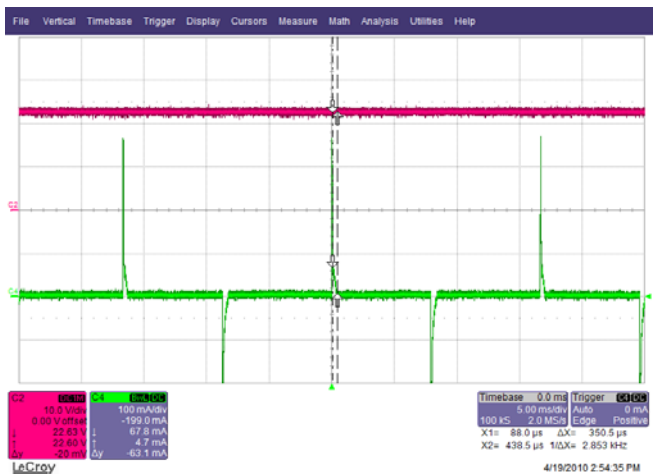
**Figure 30** – 115 VAC, Full Phase.  
Upper:  $V_{OUT}$ , 10 V / div.  
Lower:  $I_{IN}$ , 0.1 A / div., 5 ms / div.



**Figure 31** – 115 VAC, 65° Phase.  
Upper:  $V_{OUT}$ , 10 V / div.  
Lower:  $I_{IN}$ , 0.1 A / div., 5 ms / div.



**Figure 32** – 115 VAC, 16° Phase.  
Upper:  $V_{OUT}$ , 10 V / div.  
Lower:  $I_{IN}$ , 0.1 A / div., 5 ms / div.

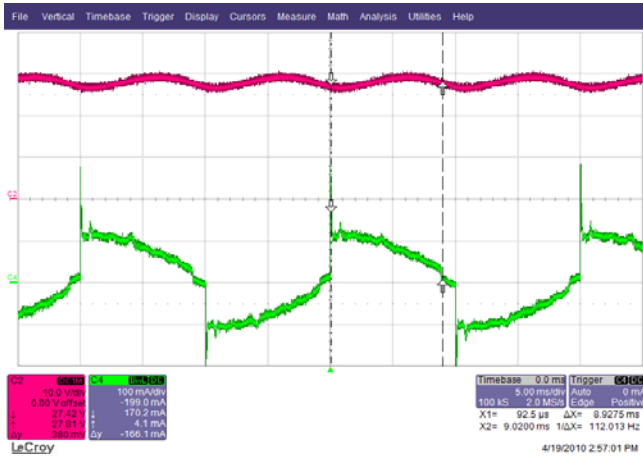


**Figure 33** – 115 VAC, 8° Phase.  
Upper:  $V_{OUT}$ , 10 V / div.  
Lower:  $I_{IN}$ , 0.1 A / div., 5 ms / div.





13.2.2  $V_{IN} = 230 \text{ VAC} / 50\text{Hz}$



**Figure 34** – 230 VAC, Full Phase.  
Upper:  $V_{OUT}$ , 10 V / div.  
Lower:  $I_{IN}$ , 0.1 A / div., 5 ms / div.



**Figure 35** – 230 VAC, 54° Phase.  
Upper:  $V_{OUT}$ , 10 V / div.  
Lower:  $I_{IN}$ , 0.1 A / div., 5 ms / div.



**Figure 36** – 230 VAC, 6° Phase.  
Upper:  $V_{OUT}$ , 10 V / div.  
Lower:  $I_{IN}$ , 0.1 A / div., 5 ms / div.



**Figure 37** – 230 VAC, 5° Phase.  
Upper:  $V_{OUT}$ , 10 V / div.  
Lower:  $I_{IN}$ , 0.1 A / div., 5 ms / div.



## 14 Line Surge

Differential and common input line 200 A ring wave testing was completed on a single test unit to IEC61000-4-5. Input voltage was set at 230 VAC / 60 Hz. Output was loaded at full load and operation was verified following each surge event.

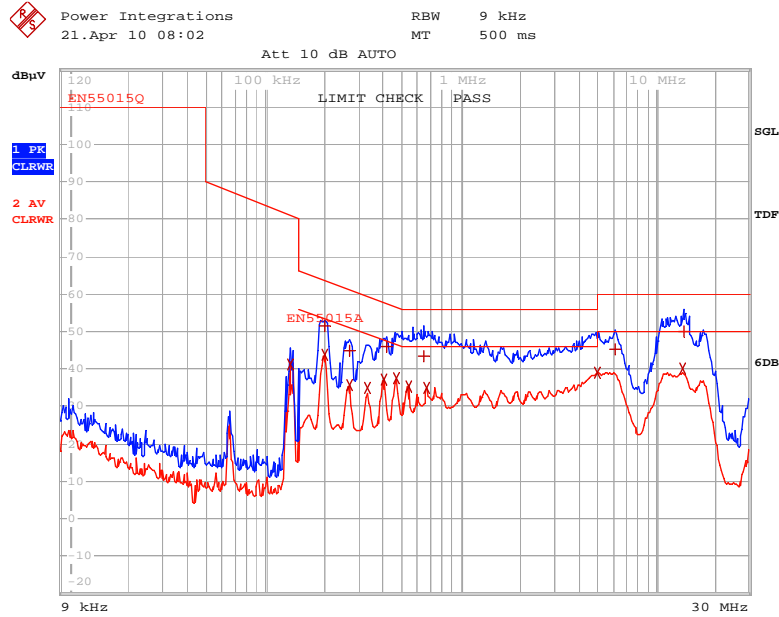
Surge Level (V)	Input Voltage (VAC)	Injection Location	Injection Phase (°)	Test Result (Pass/Fail)
2500	230	L to N	90	Pass
2500	230	L to N	90	Pass
2500	230	L to PE	90	Pass
2500	230	L to PE	90	Pass
2500	230	N to PE	90	Pass
2500	230	N to PE	90	Pass

Unit passes under all test conditions.



### 15 Conducted EMI

Note: Blue results represents peak detector vs. quasi peak limit line. For actual margin to limit (quasi peak measurement vs. quasi peak limit) please refer to the table.



EDIT PEAK LIST (Final Measurement Results)				
TRACE	FREQUENCY	LEVEL dBµV		DELTA LIMIT dB
Trace1:	EN55015Q			
Trace2:	EN55015A			
Trace3:	---			
2 Average	134.789536006 kHz	41.13	N gnd	
1 Quasi Peak	200.175581485 kHz	51.44	N gnd	-12.16
2 Average	200.175581485 kHz	43.79	N gnd	-9.81
1 Quasi Peak	267.135089486 kHz	44.80	N gnd	-16.40
2 Average	267.135089486 kHz	35.58	N gnd	-15.62
2 Average	332.507282579 kHz	35.10	L1 gnd	-14.28
2 Average	401.705024172 kHz	37.16	N gnd	-10.64
1 Quasi Peak	418.01585899 kHz	46.10	N gnd	-11.38
2 Average	466.367062279 kHz	37.33	N gnd	-9.24
2 Average	536.076911993 kHz	35.42	N gnd	-10.57
1 Quasi Peak	641.227045055 kHz	43.24	N gnd	-12.75
2 Average	667.263434405 kHz	35.08	L1 gnd	-10.91
2 Average	4.97983359306 MHz	38.94	N gnd	-7.05
1 Quasi Peak	6.1984778522 MHz	45.35	N gnd	-14.64
2 Average	13.6042179984 MHz	40.09	L1 gnd	-9.90
1 Quasi Peak	13.8776627802 MHz	49.91	L1 gnd	-10.08

Figure 38 – Conducted EMI, Maximum Steady State Load, 115 VAC, 60 Hz, and EN55015 B Limits.





EDIT PEAK LIST (Final Measurement Results)

Trace1:	EN55015Q
Trace2:	EN55015A
Trace3:	---

TRACE	FREQUENCY	LEVEL dBµV	DELTA LIMIT dB
2 Average	9.272709 kHz	23.48 N gnd	
2 Average	134.789536006 kHz	41.52 N gnd	
1 Quasi Peak	190.46019728 kHz	47.24 L1 gnd	-16.77
2 Average	200.175581485 kHz	39.24 L1 gnd	-14.35
1 Quasi Peak	264.49018761 kHz	45.98 L1 gnd	-15.30
2 Average	267.135089486 kHz	37.12 N gnd	-14.08
1 Quasi Peak	332.507282579 kHz	41.97 N gnd	-17.41
2 Average	332.507282579 kHz	33.19 N gnd	-16.19
1 Quasi Peak	401.705024172 kHz	42.37 L1 gnd	-15.44
2 Average	401.705024172 kHz	32.83 L1 gnd	-14.98
2 Average	466.367062279 kHz	33.81 N gnd	-12.76
1 Quasi Peak	471.030732902 kHz	44.01 N gnd	-12.47
2 Average	598.084042089 kHz	31.96 N gnd	-14.03
1 Quasi Peak	673.936068749 kHz	42.26 N gnd	-13.73
2 Average	6.07634335085 MHz	40.39 N gnd	-9.60
1 Quasi Peak	6.26046263072 MHz	45.96 N gnd	-14.03
2 Average	13.6042179984 MHz	41.54 L1 gnd	-8.45
1 Quasi Peak	13.7402601784 MHz	49.67 L1 gnd	-10.32

Figure 39 – Conducted EMI, Maximum Steady State Load, 230 VAC, 60 Hz, and EN55015 B Limits.



### 16 Production Distribution Data

Each RD-194 is ATE tested prior to shipping and the data for output current is presented below for a fixed line condition of 115 VAC and a device temperature of 50°C. This shows very low unit to unit variation (sigma of 8.5 mA) which includes both the device and external component influences.

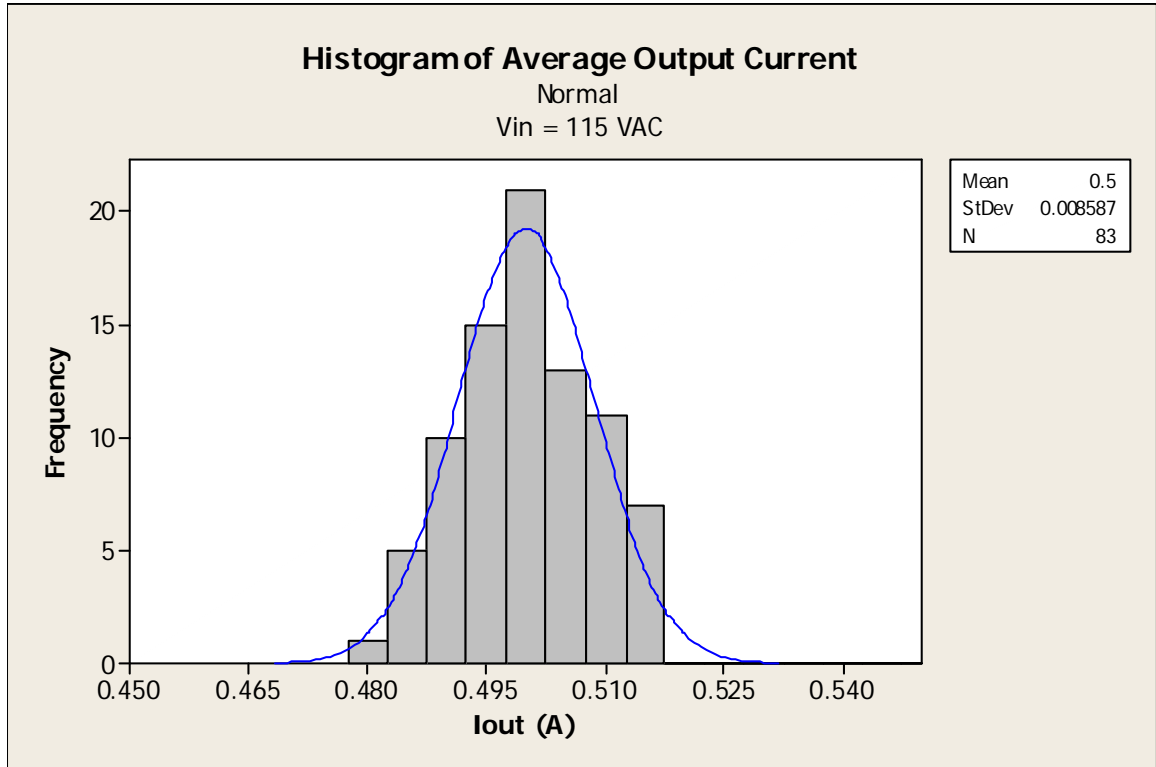


Figure 40 – Production Variation of I<sub>OUT</sub> at 115 VAC

**17 Revision History**

<b>Date</b>	<b>Author</b>	<b>Revision</b>	<b>Description &amp; changes</b>	<b>Reviewed</b>
09-Jun-10	DK	1.0	Initial Release	Apps & Mktg
14-Dec-10	DK	1.1	Updated Section 6, 11 and 13.1	Apps & Mktg



## 18 Appendix

### 18.1 Dimming Test with TRIAC Dimmer Switches

#### 18.1.1 $V_{IN} = 115 \text{ VAC} / 60 \text{ Hz}$

Style	Country	Manufacturer	Model number	Dimming Test Data		
				Max Current (mA)	Controlled Min. Current (mA)	Min. Current without Off Switch (mA)
<b>Rotary</b>						
1	Taiwan		WS-5005	500	2	0
2	USA	Leviton	OB4911	500	4	0
<b>Slider</b>						
1	USA	Lutron	GLR11-F38875	450	6	0
2	Taiwan	SG Electric	XH004186	490	63	0

#### 18.1.2 $V_{IN} = 230 \text{ VAC} / 50 \text{ Hz}$

Note output was not normalized (value of feedback resistor adjusted) for 230 VAC operation. When normalized a value of ~600 mA equates to a value of ~500 mA.

Style	Country	Manufacturer	Model Number	Dimming Test Data		
				Max. Current (mA)	Controlled Min. Current (mA)	Min. Current without Off Switch (mA)
<b>Rotary</b>						
1	Taiwan		Y-25088A	598	3	0
2	Taiwan		Y-25082A	595	2	0
3	Taiwan		D-2160B	597		61
4	China	CLIPMEI		593	4	0
5	China	LBR		595		125
6	China	KBE		593	10	0
7	China	MANK	MK/TG100001	595		157
8	China	SB Electric	BM2	580	4	0
9	China	EBAHuang		593	5	0
10	China	Myongbo		596		135
11	China	TCL	L2.0	596		75
12	Italy	RTS34DLI		590		75



## 18.2 Audible Noise Test Data

Unit measured open frame with calibrated laboratory microphone placed 25 mm above the transformer.

Results show very acceptable audible noise levels created by supply when using leading edge phase angle dimming. Levels measured were only slightly above noise floor.

### 18.2.1 $V_{IN} = 115$ VAC, Full Phase

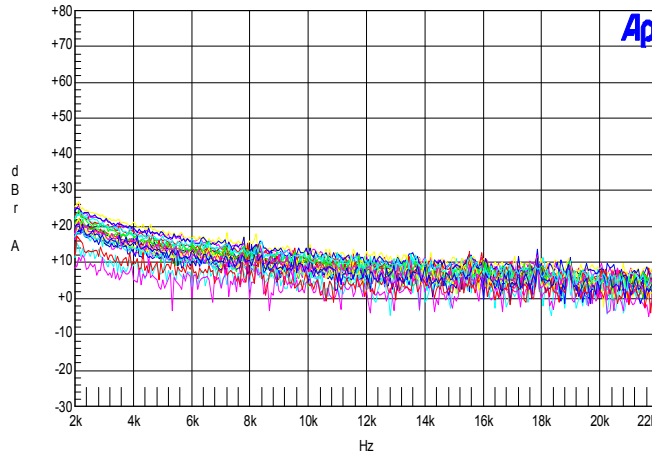


Figure 41 – 2 kHz – 22 kHz.

### 18.2.2 $V_{IN} = 115$ VAC, Half Phase

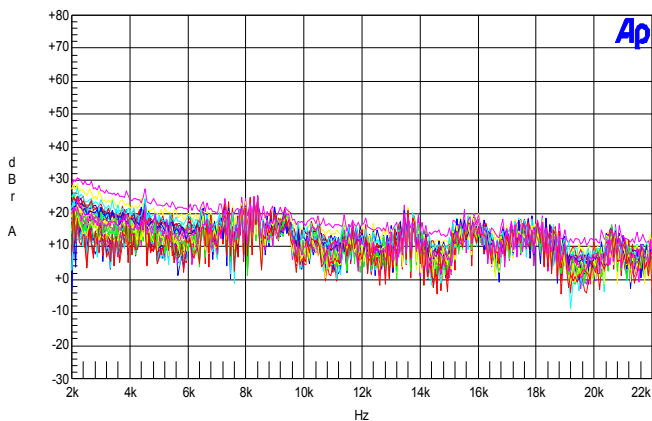


Figure 42 – 2 kHz – 22 kHz.





18.2.3  $V_{IN} = 230 \text{ VAC}$ , Full Phase

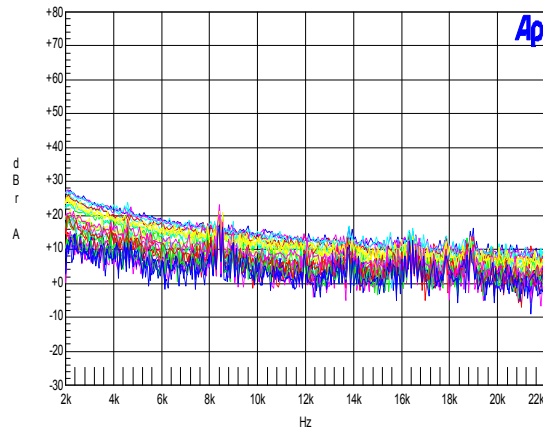


Figure 43 – 2 kHz – 22 kHz.

18.2.4  $V_{IN} = 230 \text{ VAC}$ , Half Phase

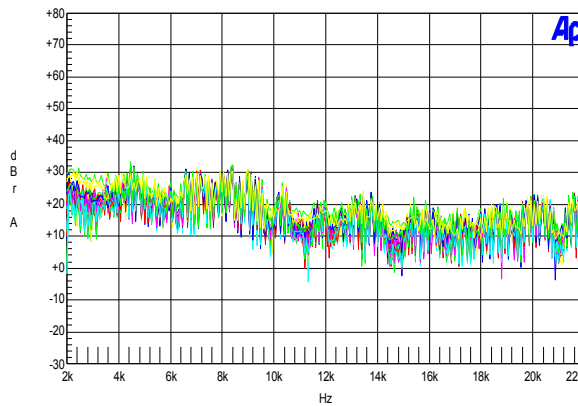


Figure 44 – 2 kHz – 22 kHz.



---

**For the latest updates, visit our website: [www.powerint.com](http://www.powerint.com)**

Power Integrations reserves the right to make changes to its products at any time to improve reliability or manufacturability. Power Integrations does not assume any liability arising from the use of any device or circuit described herein. POWER INTEGRATIONS MAKES NO WARRANTY HEREIN AND SPECIFICALLY DISCLAIMS ALL WARRANTIES INCLUDING, WITHOUT LIMITATION, THE IMPLIED WARRANTIES OF MERCHANTABILITY, FITNESS FOR A PARTICULAR PURPOSE, AND NON-INFRINGEMENT OF THIRD PARTY RIGHTS.

**PATENT INFORMATION**

The products and applications illustrated herein (including transformer construction and circuits external to the products) may be covered by one or more U.S. and foreign patents, or potentially by pending U.S. and foreign patent applications assigned to Power Integrations. A complete list of Power Integrations' patents may be found at [www.powerint.com](http://www.powerint.com). Power Integrations grants its customers a license under certain patent rights as set forth at <http://www.powerint.com/ip.htm>.

The PI Logo, TOPSwitch, TinySwitch, LinkSwitch, DPA-Switch, PeakSwitch, EcoSmart, Clampless, E-Shield, Filterfuse, StackFET, PI Expert and PI FACTS are trademarks of Power Integrations, Inc. Other trademarks are property of their respective companies. ©Copyright 2010 Power Integrations, Inc.

---

## Power Integrations Worldwide Sales Support Locations

**WORLD HEADQUARTERS**

5245 Hellyer Avenue  
San Jose, CA 95138, USA.  
Main: +1-408-414-9200  
Customer Service:  
Phone: +1-408-414-9665  
Fax: +1-408-414-9765  
e-mail:  
[usasales@powerint.com](mailto:usasales@powerint.com)

**GERMANY**

Rueckertstrasse 3  
D-80336, Munich  
Germany  
Phone: +49-89-5527-3911  
Fax: +49-89-5527-3920  
e-mail:  
[eurosales@powerint.com](mailto:eurosales@powerint.com)

**JAPAN**

Kosei Dai-3 Building  
2-12-11, Shin-Yokohama,  
Kohoku-ku, Yokohama-shi,  
Kanagawa 222-0033  
Japan  
Phone: +81-45-471-1021  
Fax: +81-45-471-3717  
e-mail: [japansales@powerint.com](mailto:japansales@powerint.com)

**TAIWAN**

5F, No. 318, Nei Hu Rd., Sec. 1  
Nei Hu District  
Taipei 114, Taiwan R.O.C.  
Phone: +886-2-2659-4570  
Fax: +886-2-2659-4550  
e-mail:  
[taiwansales@powerint.com](mailto:taiwansales@powerint.com)

**CHINA (SHANGHAI)**

Rm 1601/1610, Tower 1  
Kerry Everbright City  
No. 218 Tianmu Road West  
Shanghai, P.R.C. 200070  
Phone: +86-021-6354-6323  
Fax: +86-021-6354-6325  
e-mail:  
[chinasales@powerint.com](mailto:chinasales@powerint.com)

**INDIA**

#1, 14<sup>th</sup> Main Road  
Vasanthanagar  
Bangalore-560052  
India  
Phone: +91-80-4113-8020  
Fax: +91-80-4113-8023  
e-mail:  
[indiasales@powerint.com](mailto:indiasales@powerint.com)

**KOREA**

RM 602, 6FL  
Korea City Air Terminal B/D, 159-6  
Samsung-Dong, Kangnam-Gu,  
Seoul, 135-728  
Korea  
Phone: +82-2-2016-6610  
Fax: +82-2-2016-6630  
e-mail: [koreasales@powerint.com](mailto:koreasales@powerint.com)

**UNITED KINGDOM**

1st Floor, St. James's House  
East Street,  
Farnham Surrey, GU9 7TJ  
United Kingdom  
Phone: +44 (0) 1252-730-141  
Fax: +44 (0) 1252-727-689  
e-mail:  
[eurosales@powerint.com](mailto:eurosales@powerint.com)

**CHINA (SHENZHEN)**

Rm A, B & C 4<sup>th</sup> Floor, Block C,  
Electronics Science and  
Technology Building  
2070 Shennan Zhong Road  
Shenzhen, Guangdong,  
P.R.C. 518031  
Phone: +86-755-8379-3243  
Fax: +86-755-8379-5828  
e-mail:  
[chinasales@powerint.com](mailto:chinasales@powerint.com)

**ITALY**

Via De Amicis 2  
20091 Bresso MI  
Italy  
Phone: +39-028-928-6000  
Fax: +39-028-928-6009  
e-mail:  
[eurosales@powerint.com](mailto:eurosales@powerint.com)

**SINGAPORE**

51 Newton Road,  
#15-08/10 Goldhill Plaza  
Singapore, 308900  
Phone: +65-6358-2160  
Fax: +65-6358-2015  
e-mail:  
[singaporesales@powerint.com](mailto:singaporesales@powerint.com)

**APPLICATIONS HOTLINE**

World Wide +1-408-414-9660

**APPLICATIONS FAX**

World Wide +1-408-414-9760

