

1.5SMCXXXAT3 Series

Zener Transient Voltage Suppressors

GENERAL DATA IS APPLICABLE TO ALL SERIES IN THIS GROUP

The SMC series is designed to protect voltage sensitive components from high voltage, high energy transients. They have excellent clamping capability, high surge capability, low zener impedance and fast response time. The SMC series is supplied in ON Semiconductor's exclusive, cost-effective, highly reliable Surmetic package and is ideally suited for use in communication systems, numerical controls, process controls, medical equipment, business machines, power supplies and many other industrial/consumer applications.

Specification Features:

- Standard Zener Breakdown Voltage Range — 6.8 to 91 V
- Stand-off Voltage Range — 5.8 to 78 V
- Peak Power — 1500 Watts @ 1 ms
- Maximum Clamp Voltage @ Peak Pulse Current
- Low Leakage < 5 μ A Above 10 V
- UL Recognition
- Maximum Temperature Coefficient Specified
- Available in Tape and Reel
- Response Time is Typically < 1 ns

Mechanical Characteristics:

CASE: Void-free, transfer-molded, thermosetting plastic

FINISH: All external surfaces are corrosion resistant and leads are readily solderable

POLARITY: Cathode indicated by molded polarity notch. When operated in zener mode, will be positive with respect to anode

MOUNTING POSITION: Any

LEADS: Modified L-Bend providing more contact area to bond pads

MAXIMUM CASE TEMPERATURE FOR SOLDERING PURPOSES:
260°C for 10 Seconds

WAFER FAB LOCATION: Phoenix, Arizona

ASSEMBLY/TEST LOCATION: Seremban, Malaysia

MAXIMUM RATINGS

Rating	Symbol	Value	Unit
Peak Power Dissipation (1) @ $T_L \leq 25^\circ\text{C}$	P _{PK}	1500	Watts
Forward Surge Current (2) @ $T_A = 25^\circ\text{C}$	I _{FSM}	200	Amps
Thermal Resistance from Junction to Lead (typical)	R _{θJL}	15	°C/W
Operating and Storage Temperature Range	T _J , T _{stg}	- 55 to +150	°C

NOTES: 1. Nonrepetitive current pulse per Figure 2 and derated above $T_A = 25^\circ\text{C}$ per Figure 3.

2. 1/2 sine wave (or equivalent square wave), PW = 8.3 ms, duty cycle = 4 pulses per minute maximum.



ON Semiconductor

Formerly a Division of Motorola

<http://onsemi.com>

PLASTIC SURFACE MOUNT ZENER OVERVOLTAGE TRANSIENT SUPPRESSORS 5.8–78 VOLTS 1500 WATT PEAK POWER



SMC
PLASTIC
CASE 403

ORDERING INFORMATION

Device	Package	Shipping
1.5SMCXXXAT3	SMC	Tape and Reel 2500 Units/Reel

Devices listed in **bold, italic** are ON Semiconductor Preferred devices. Preferred devices are recommended choices for future use and best overall value.

1.5SMCXXXAT3 Series

ELECTRICAL CHARACTERISTICS ($T_A = 25^\circ\text{C}$ unless otherwise noted) $V_F = 3.5\text{ V Max}$, $I_F^{**} = 100\text{ A}$ for all types.

Device††	Breakdown Voltage*				Working Peak Reverse Voltage V_{RWM} Volts	Maximum Reverse Leakage @ V_{RWM} I_R μA	Maximum Reverse Surge Current I_{RSM}^\dagger Amps	Maximum Reverse Voltage @ I_{RSM} (Clamping Voltage) V_{RSM} Volts	Maximum Temperature Coefficient of V_{BR} $\%/^\circ\text{C}$	Device Marking
	V_{BR} @ I_T Volts									
	Min	Nom	Max	mA						
1.5SMC6.8AT3	6.45	6.8	7.14	10	5.8	1000	143	10.5	0.057	6V8A
1.5SMC7.5AT3	7.13	7.5	7.88	10	6.4	500	132	11.3	0.061	7V5A
1.5SMC8.2AT3	7.79	8.2	8.61	10	7.02	200	124	12.1	0.065	8V2A
1.5SMC9.1AT3	8.65	9.1	9.55	1	7.78	50	112	13.4	0.068	9V1A
1.5SMC10AT3	9.5	10	10.5	1	8.55	10	103	14.5	0.073	10A
1.5SMC11AT3	10.5	11	11.6	1	9.4	5	96	15.6	0.075	11A
1.5SMC12AT3	11.4	12	12.6	1	10.2	5	90	16.7	0.078	12A
1.5SMC13AT3	12.4	13	13.7	1	11.1	5	82	18.2	0.081	13A
1.5SMC15AT3	14.3	15	15.8	1	12.8	5	71	21.2	0.084	15A
1.5SMC16AT3	15.2	16	16.8	1	13.6	5	67	22.5	0.086	16A
1.5SMC18AT3	17.1	18	18.9	1	15.3	5	59.5	25.2	0.088	18A
1.5SMC20AT3	19	20	21	1	17.1	5	54	27.7	0.09	20A
1.5SMC22AT3	20.9	22	23.1	1	18.8	5	49	30.6	0.092	22A
1.5SMC24AT3	22.8	24	25.2	1	20.5	5	45	33.2	0.094	24A
1.5SMC27AT3	25.7	27	28.4	1	23.1	5	40	37.5	0.096	27A
1.5SMC30AT3	28.5	30	31.5	1	25.6	5	36	41.4	0.097	30A
1.5SMC33AT3	31.4	33	34.7	1	28.2	5	33	45.7	0.098	33A
1.5SMC36AT3	34.2	36	37.8	1	30.8	5	30	49.9	0.099	36A
1.5SMC39AT3	37.1	39	41	1	33.3	5	28	53.9	0.1	39A
1.5SMC43AT3	40.9	43	45.2	1	36.8	5	25.3	59.3	0.101	43A
1.5SMC47AT3	44.7	47	49.4	1	40.2	5	23.2	64.8	0.101	47A
1.5SMC51AT3	48.5	51	53.6	1	43.6	5	21.4	70.1	0.102	51A
1.5SMC56AT3	53.2	56	58.8	1	47.8	5	19.5	77	0.103	56A
1.5SMC62AT3	58.9	62	65.1	1	53	5	17.7	85	0.104	62A
1.5SMC68AT3	64.6	68	71.4	1	58.1	5	16.3	92	0.104	68A
1.5SMC75AT3	71.3	75	78.8	1	64.1	5	14.6	103	0.105	75A
1.5SMC82AT3	77.9	82	86.1	1	70.1	5	13.3	113	0.105	82A
1.5SMC91AT3	86.5	91	95.5	1	77.8	5	12	125	0.106	91A

Devices listed in bold, italic are ON Semiconductor Preferred devices.

* V_{BR} measured at pulse test current I_T at an ambient temperature of 25°C .

** 1/2 sine wave (or equivalent square wave), $PW = 8.3\text{ ms}$, duty cycle = 4 pulses per minute maximum.

† Surge current waveform per Figure 2 and derate per Figure 3 of General Data — 1500 Watt at the beginning of this group.

†† T3 suffix designates tape and reel of 2500 units.

1.5SMCXXXAT3 Series

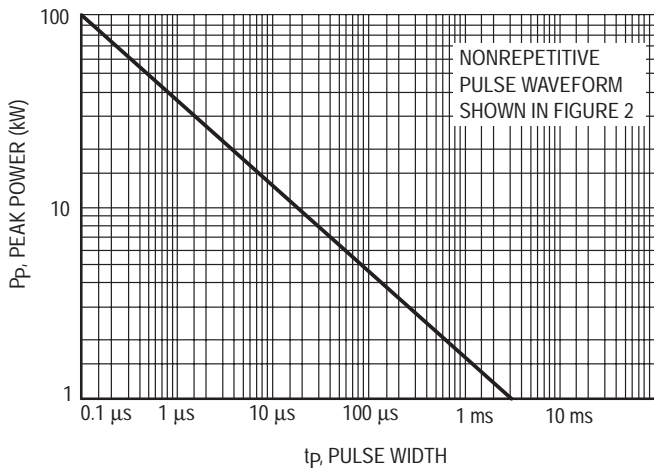

Figure 1. Pulse Rating Curve

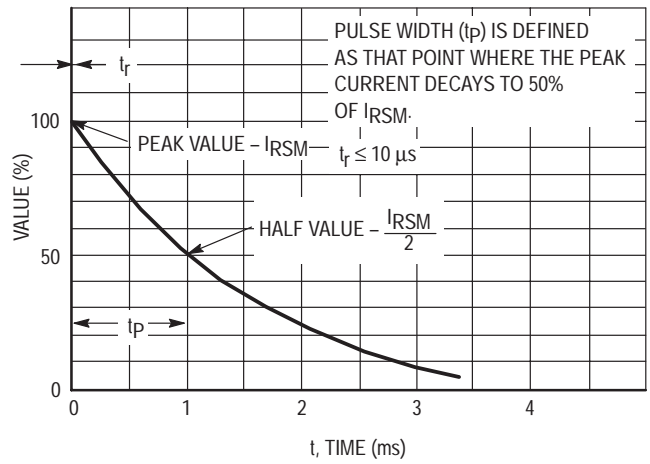

Figure 2. Pulse Waveform

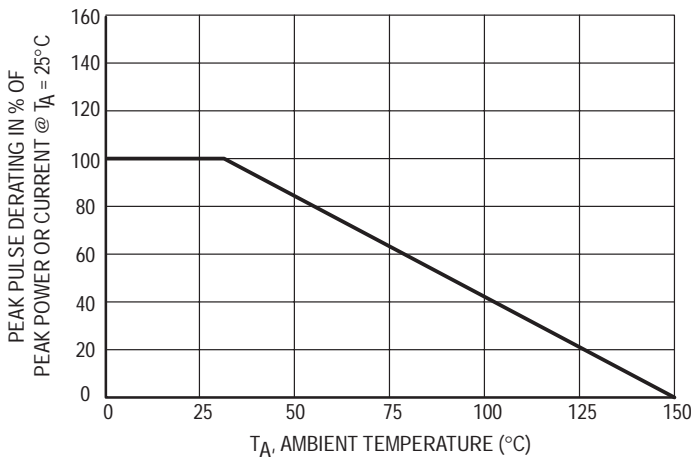

Figure 3. Pulse Derating Curve

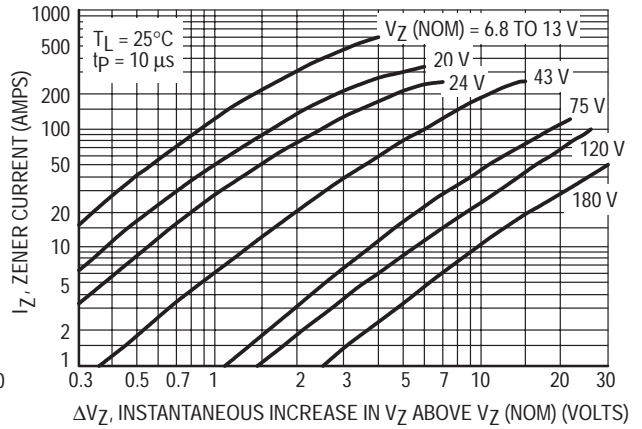

Figure 4. Dynamic Impedance

UL RECOGNITION

The entire series has *Underwriters Laboratory Recognition* for the classification of protectors (QVGV2) under the UL standard for safety 497B and File #116110. Many competitors only have one or two devices recognized or have recognition in a non-protective category. Some competitors have no recognition at all. With the UL497B recognition, our parts successfully passed several tests

including Strike Voltage Breakdown test, Endurance Conditioning, Temperature test, Dielectric Voltage-Withstand test, Discharge test and several more.

Whereas, some competitors have only passed a flammability test for the package material, we have been recognized for much more to be included in their Protector category.

1.5SMCXXXAT3 Series

APPLICATION NOTES

RESPONSE TIME

In most applications, the transient suppressor device is placed in parallel with the equipment or component to be protected. In this situation, there is a time delay associated with the capacitance of the device and an overshoot condition associated with the inductance of the device and the inductance of the connection method. The capacitive effect is of minor importance in the parallel protection scheme because it only produces a time delay in the transition from the operating voltage to the clamp voltage as shown in Figure 5.

The inductive effects in the device are due to actual turn-on time (time required for the device to go from zero current to full current) and lead inductance. This inductive effect produces an overshoot in the voltage across the equipment or component being protected as shown in Figure 6. Minimizing this overshoot is very important in the application, since the main purpose for adding a transient suppressor is to clamp voltage spikes. The SMC series have a very good response time, typically < 1 ns and negligible inductance. However, external inductive effects could produce unacceptable overshoot. Proper circuit layout,

minimum lead lengths and placing the suppressor device as close as possible to the equipment or components to be protected will minimize this overshoot.

Some input impedance represented by Z_{in} is essential to prevent overstress of the protection device. This impedance should be as high as possible, without restricting the circuit operation.

DUTY CYCLE DERATING

The data of Figure 1 applies for non-repetitive conditions and at a lead temperature of 25°C. If the duty cycle increases, the peak power must be reduced as indicated by the curves of Figure 7. Average power must be derated as the lead or ambient temperature rises above 25°C. The average power derating curve normally given on data sheets may be normalized and used for this purpose.

At first glance the derating curves of Figure 7 appear to be in error as the 10 ms pulse has a higher derating factor than the 10 μ s pulse. However, when the derating factor for a given pulse of Figure 7 is multiplied by the peak power value of Figure 1 for the same pulse, the results follow the expected trend.

1.5SMCXXXAT3 Series

TYPICAL PROTECTION CIRCUIT

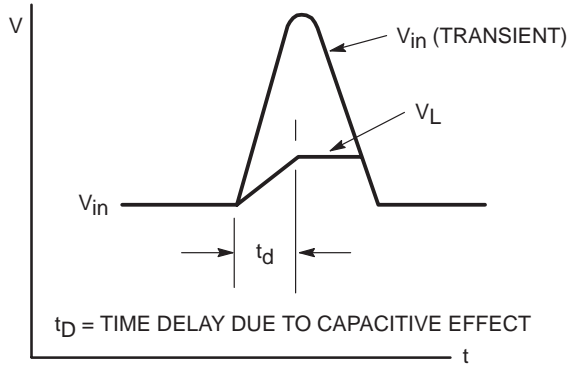
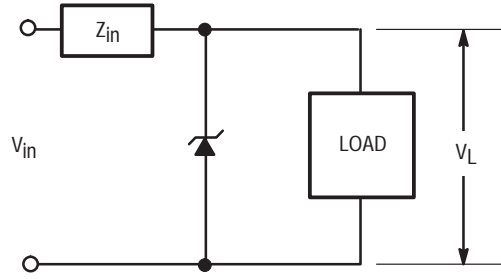

Figure 5.

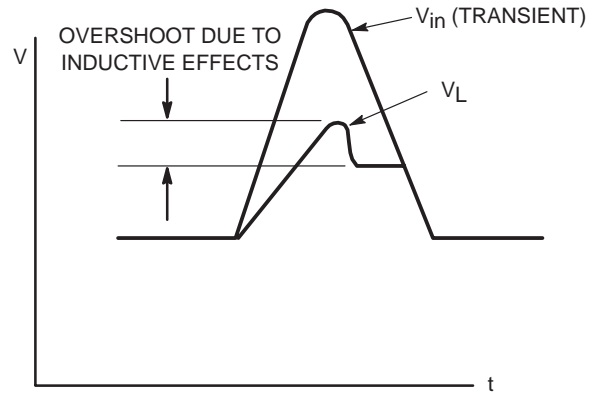

Figure 6.

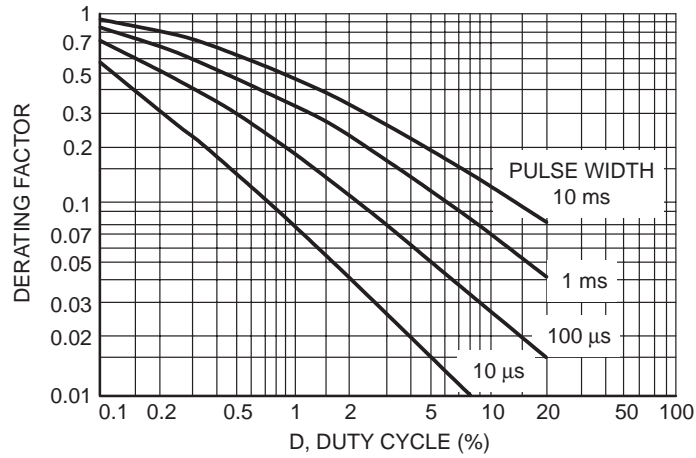

Figure 7. Typical Derating Factor for Duty Cycle

1.5SMCXXXAT3 Series

OUTLINE DIMENSIONS

Transient Voltage Suppressors – Surface Mounted

1500 Watt Peak Power

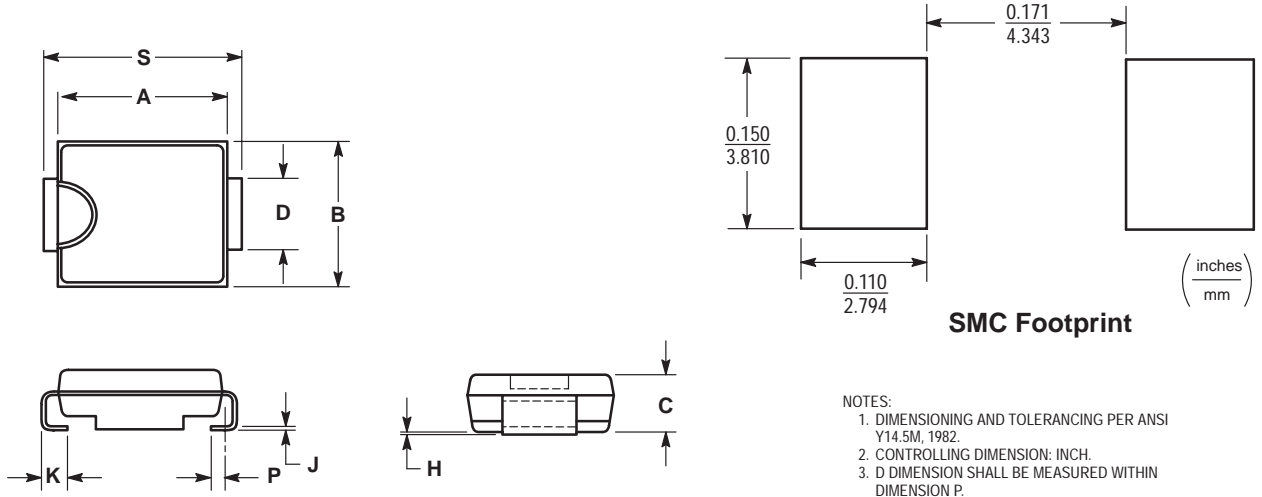

SMC Footprint

- NOTES:
1. DIMENSIONING AND TOLERANCING PER ANSI Y14.5M, 1982.
 2. CONTROLLING DIMENSION: INCH.
 3. D DIMENSION SHALL BE MEASURED WITHIN DIMENSION P.

DIM	INCHES		MILLIMETERS	
	MIN	MAX	MIN	MAX
A	0.260	0.280	6.60	7.11
B	0.220	0.240	5.59	6.10
C	0.075	0.095	1.90	2.41
D	0.115	0.121	2.92	3.07
H	0.0020	0.0060	0.051	0.152
J	0.006	0.012	0.15	0.30
K	0.030	0.050	0.76	1.27
P	0.020 REF		0.51 REF	
S	0.305	0.320	7.75	8.13

**CASE 403
(SMC)**

(Refer to Section 10 of the TVS/Zener Data Book (DL150/D) for Surface Mount, Thermal Data and Footprint Information.)

Notes

1.5SMCXXXAT3 Series

ON Semiconductor and  are trademarks of Semiconductor Components Industries, LLC (SCILLC). SCILLC reserves the right to make changes without further notice to any products herein. SCILLC makes no warranty, representation or guarantee regarding the suitability of its products for any particular purpose, nor does SCILLC assume any liability arising out of the application or use of any product or circuit, and specifically disclaims any and all liability, including without limitation special, consequential or incidental damages. "Typical" parameters which may be provided in SCILLC data sheets and/or specifications can and do vary in different applications and actual performance may vary over time. All operating parameters, including "Typicals" must be validated for each customer application by customer's technical experts. SCILLC does not convey any license under its patent rights nor the rights of others. SCILLC products are not designed, intended, or authorized for use as components in systems intended for surgical implant into the body, or other applications intended to support or sustain life, or for any other application in which the failure of the SCILLC product could create a situation where personal injury or death may occur. Should Buyer purchase or use SCILLC products for any such unintended or unauthorized application, Buyer shall indemnify and hold SCILLC and its officers, employees, subsidiaries, affiliates, and distributors harmless against all claims, costs, damages, and expenses, and reasonable attorney fees arising out of, directly or indirectly, any claim of personal injury or death associated with such unintended or unauthorized use, even if such claim alleges that SCILLC was negligent regarding the design or manufacture of the part. SCILLC is an Equal Opportunity/Affirmative Action Employer.

PUBLICATION ORDERING INFORMATION

North America Literature Fulfillment:

Literature Distribution Center for ON Semiconductor
P.O. Box 5163, Denver, Colorado 80217 USA
Phone: 303-675-2175 or 800-344-3860 Toll Free USA/Canada
Fax: 303-675-2176 or 800-344-3867 Toll Free USA/Canada
Email: ONlit@hibbertco.com

N. American Technical Support: 800-282-9855 Toll Free USA/Canada

EUROPE: LDC for ON Semiconductor – European Support

German Phone: (+1) 303-308-7140 (M-F 2:30pm to 5:00pm Munich Time)
Email: ONlit-german@hibbertco.com
French Phone: (+1) 303-308-7141 (M-F 2:30pm to 5:00pm Toulouse Time)
Email: ONlit-french@hibbertco.com
English Phone: (+1) 303-308-7142 (M-F 1:30pm to 5:00pm UK Time)
Email: ONlit@hibbertco.com

ASIA/PACIFIC: LDC for ON Semiconductor – Asia Support

Phone: 303-675-2121 (Tue-Fri 9:00am to 1:00pm, Hong Kong Time)
Toll Free from Hong Kong 800-4422-3781
Email: ONlit-asia@hibbertco.com

JAPAN: ON Semiconductor, Japan Customer Focus Center

4-32-1 Nishi-Gotanda, Shinagawa-ku, Tokyo, Japan 141-8549
Phone: 81-3-5487-8345
Email: r14153@onsemi.com

Fax Response Line: 303-675-2167
800-344-3810 Toll Free USA/Canada

ON Semiconductor Website: <http://onsemi.com>

For additional information, please contact your local Sales Representative.